

The Datum Flow Chain

- Goals of this class
 - Pull together features, constraint, key characteristics, and tolerances
 - Present a diagramming technique for designing assemblies top-down
 - Do examples

What Happens During Assembly?

- Most people seem to think that assembly is fastening
- Assembly is really chaining together of dimensional relationships and constraints
- The success of these chains determines the success of the product's quality from an assembly point of view
- A goal of assembly design is to permit these chains to be defined as the basis for designing assemblies first, then designing parts

Assembly Design Overview

- The theory has three elements
 - constraint defines **how** parts are located with respect to each other
 - assembly features on parts define **where** parts are located with respect to each other
 - tolerances on feature size and location define **how accurately** parts should be located with respect to each other
- The DFC creates a top-down model that supports all three elements

Range of Application of the DFC

- Smallest: inside each part (what people do now)
- Mid-range: across a set of parts (done occasionally or in response to problems)
- Across parts and assembly machines and fixtures
- Across items obtained from or designed by suppliers (rarely is the need recognized)
- The link between top level quality and all supporting steps and processes

The DFC is **Not** Tolerance Analysis

- The DFC allows us to **design the scheme** by which the tolerances will be achieved
- It does this in the context of creating the constraint structure by which the parts will be located
- Once we design the constraint structure and the DFC, we can analyze the tolerance capability of this structure
- Often we will find that assembly sequences or tooling schemes will have to be modified

Datum Flow Chain

- A DFC is a directed acyclic graph that defines the relationships between assembled parts as well as assembly fixtures, tooling, and equipment such as robots

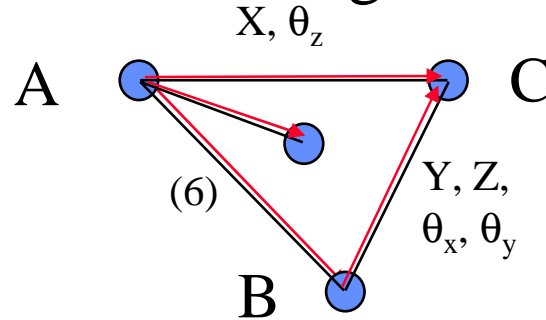

- A DFC identifies the part mates that convey dimensional control and identifies the hierarchy that determines which parts or fixtures define the locations of which other parts
- DFCs also contain information on the type of mating feature and the amount of motion constraint applied by that feature

Mates and Contacts

- We have separated joints between parts into two classes:
 - “**Mates**” convey dimensional location and constraint from one part to another
 - when all of a part’s mates are complete, it should be constrained in all 6 degrees of freedom unless free motion is part of its function
 - “**Contacts**” are redundant and provide strength or partial constraint

Example: car wheel, hub, and studs

- The KCs are:

- wheel perpendicular to axle axis
- wheel concentric with axle axis

- Part features that deliver the KCs are:

- hub face perpendicular to axle axis
- hub rim concentric with axle axis
- wheel rim hole concentric with wheel body
- wheel face parallel to rim hole plane

- The rim-to-hole joint is the mate, the studs and nuts are contacts (no geometric KC circumferentially)

- Alternate design has 5 or 6 studs, no rim

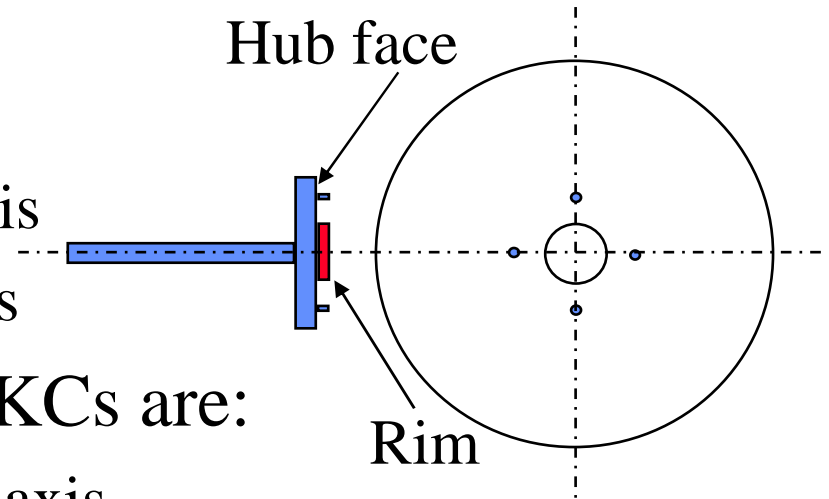

Liaison Diagrams and DFCs

- The liaison diagram shows parts and joints
- The DFC emphasizes the **mates**

Liaison Diagram

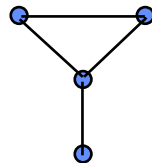

Datum Flow Chain

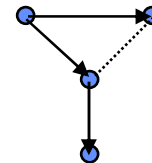

Stapler KCs

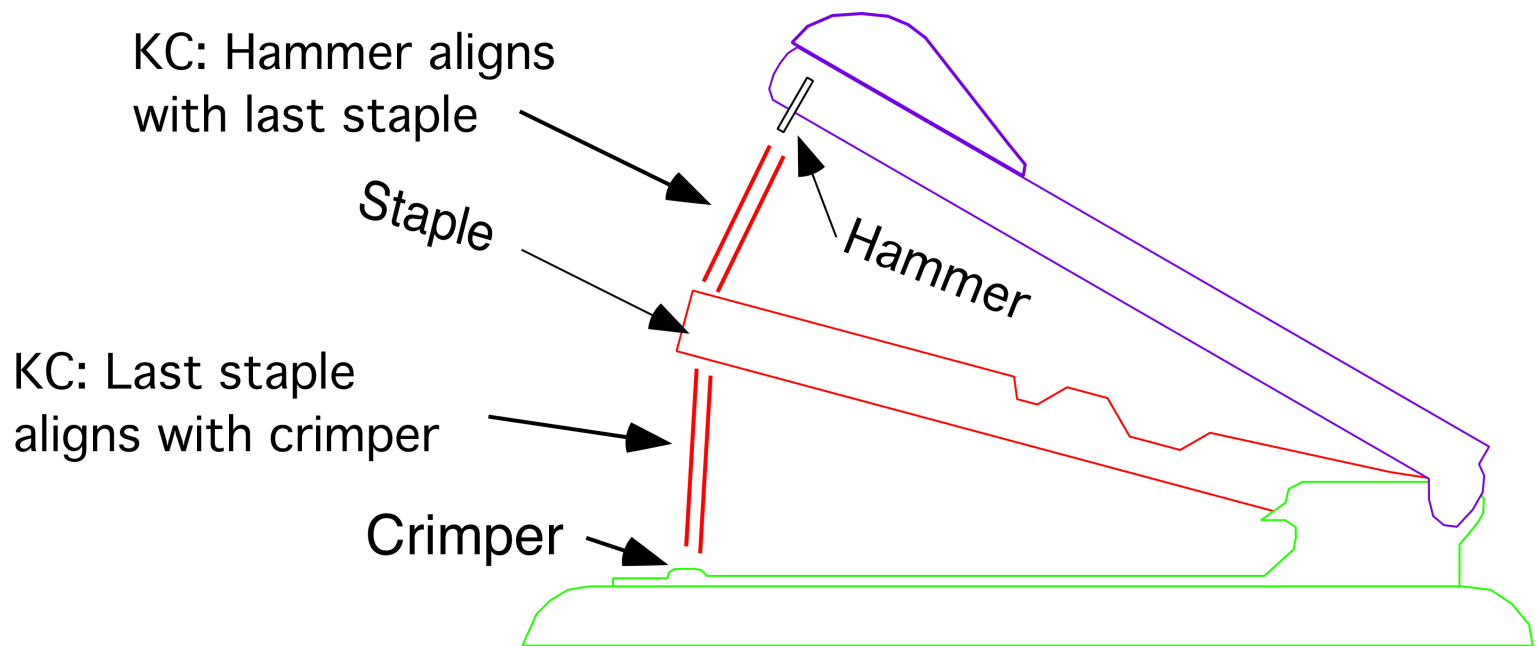

Each KC is Delivered by a Chain

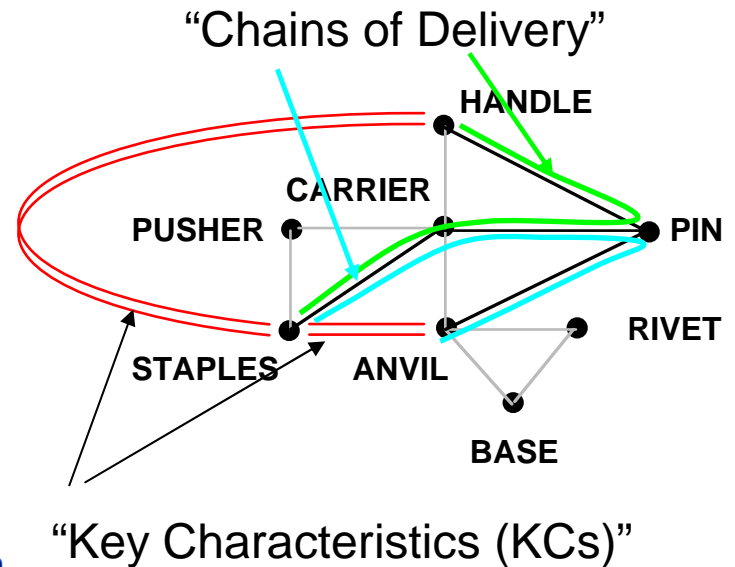
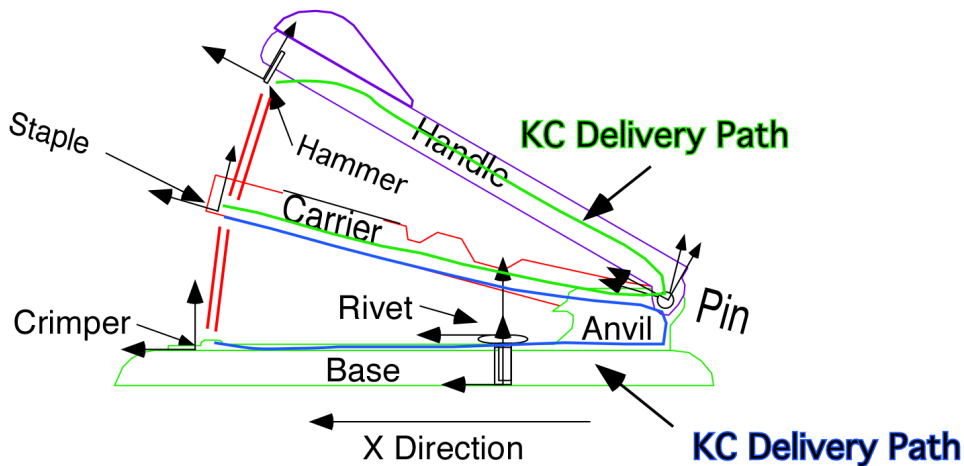
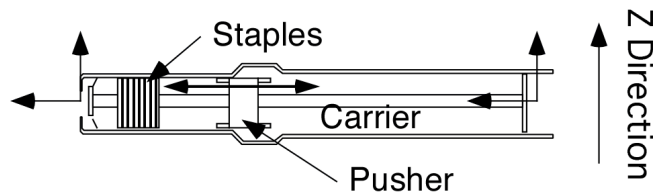

Mates, Contacts, and KC Delivery

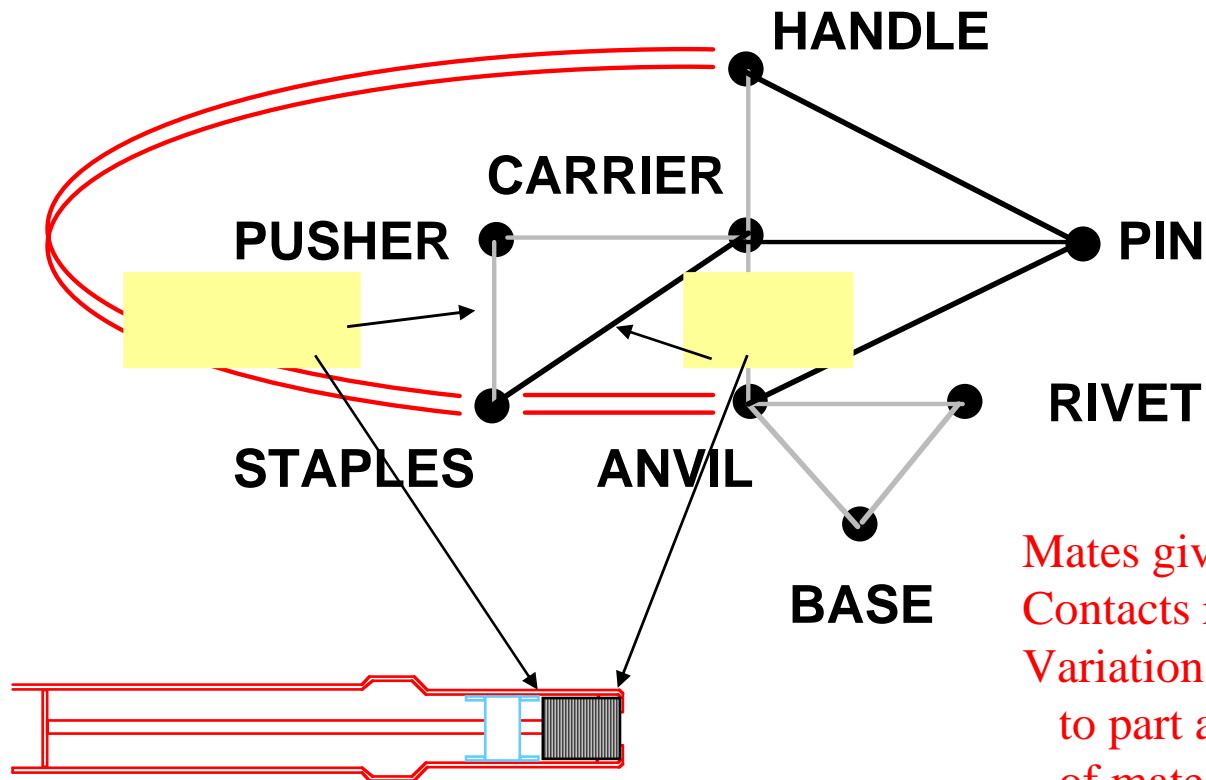

Mates give location.
Contacts reinforce location.
Variation travels from part
to part along the chain
of mates.

DFCs and KCs

- The DFC delivers the KCs by linking the mates
- There must be a chain of mates from one side of the KC to the other
- When there is no direct mate or chain of mates, a fixture or gage is needed

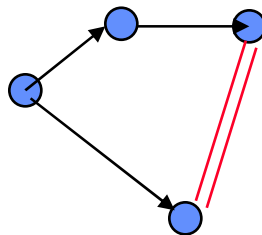

Nominal and Variation

- The DFC is the constraint plan for getting the parts to the right places in space so as to deliver the KC
- Each KC should have its own DFC
 - Often this is impossible, creating KC conflict
- If there is variation in the parts, then it flows to the KC along the DFC
 - The DFC is the “tolerance chain”
- Variation is passed by the mates, not the contacts
 - Variation, like constraint, is passed along in the wrench space of surface contacts inside features

Twist Space and Wrench Space Describe the Behavior of Two Surfaces in Contact

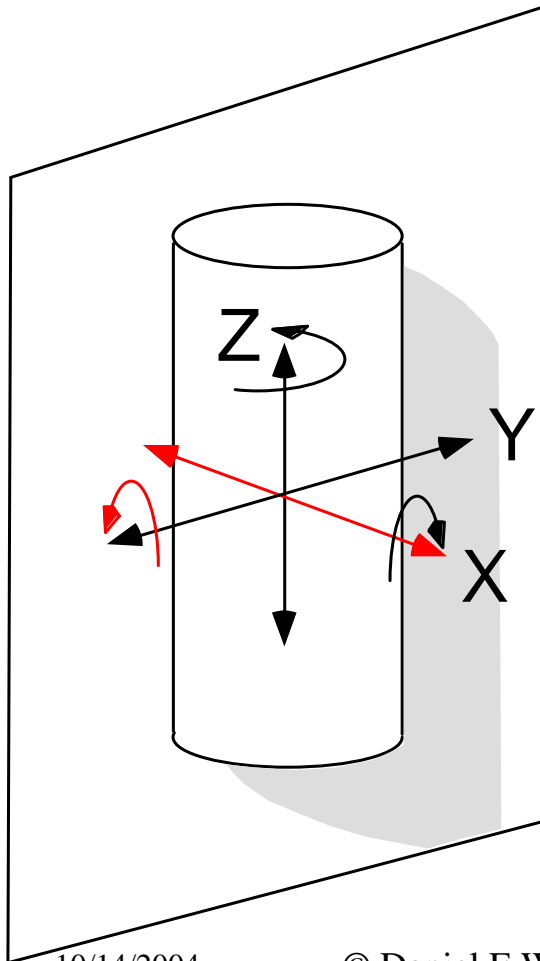

WRENCH SPACE

TWIST SPACE

Rigorous Definition of Mates and Contacts

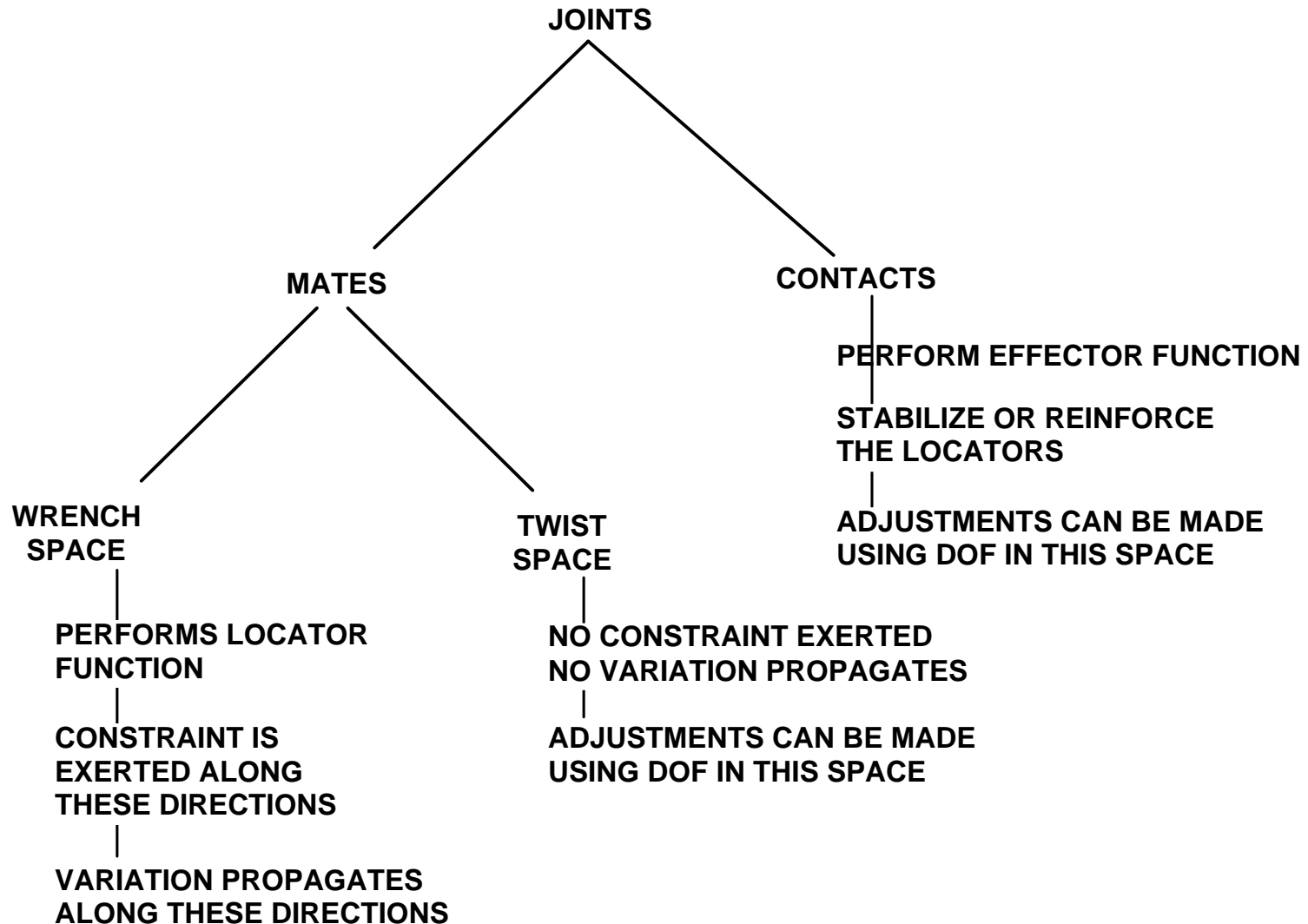

Type 1 and Type 2 Assemblies

- **Type 1** assemblies arrive at the assembly line with all their **assembly features** on them
- These features are determined by functional needs
- Assembly consists of “putting them together” by joining the **mates**. Fixtures are not needed
- After the mates locating a part are joined, any remaining **contacts** can be joined
- Examples: crankshaft into block, wrist pin into piston and conn rod, head onto block (dowel pins + head face = the mate, head bolts = the contact)

Type 1 and Type 2 Assemblies - 2

- **Type 2** assemblies have some incomplete assembly features on them when they arrive at the assembly line
 - these features do not provide enough constraint to completely determine where the adjacent part will be
- These incomplete features are called **contacts**
 - they don't carry any KCs
- Assembly operations that join contacts require additional constraint provided by measurements or fixtures (fixture = passive measurement)
- Examples: slip joints in car bodies and aircraft fuselages

A Hybrid Type

- Selective assembly is an intermediate form between Type 1 and Type 2
- The parts have complete mate features when they arrive at the assembly line
- However, a fixture or measurement is required
- Instead of a slip joint, a selected intermediate part is used
- The resulting joint can be a mate or a contact
 - select main crankshaft bearing is a **mate**
 - select solid valve lifter is a **contact**

Types of Variation Problems

Passive Assembly

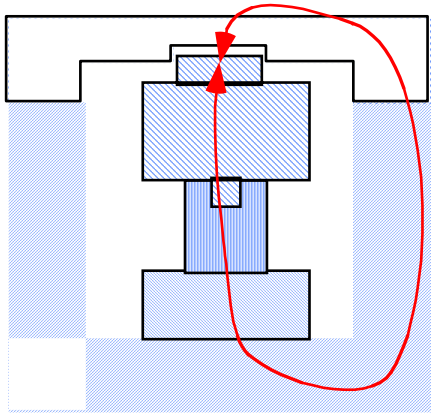

1. Type-1: Finished assembly configuration

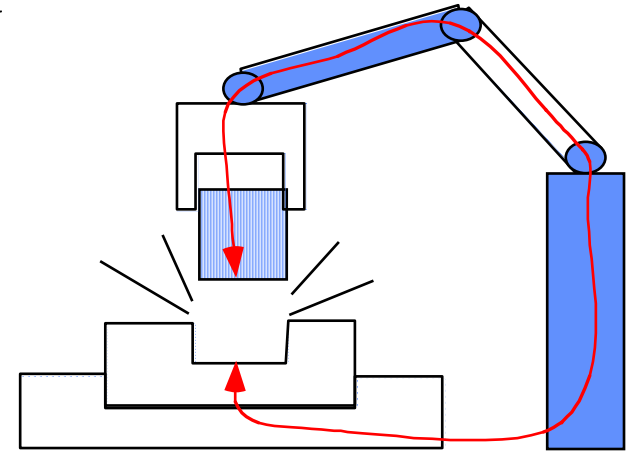

2. Type-1: In process: Assemblability

Active Assembly

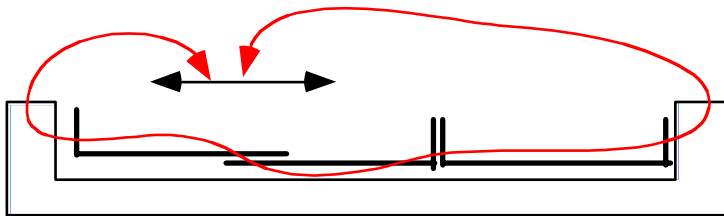

3. Type-2: Adjustable using fixtures

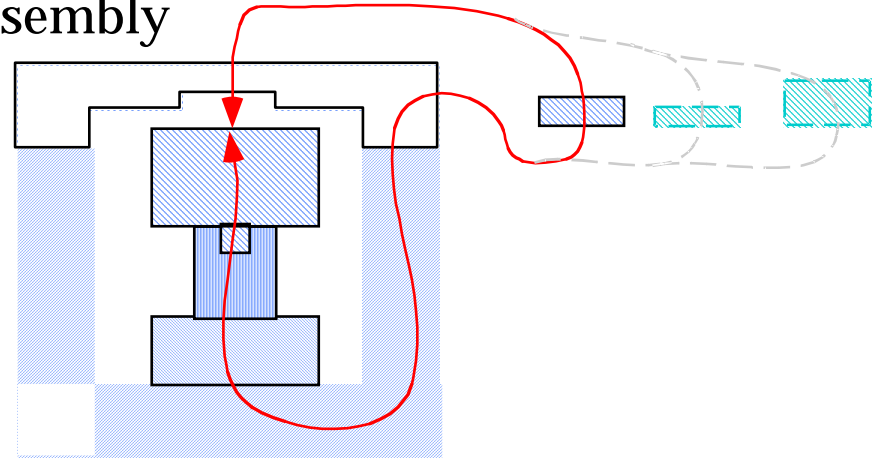

4. Hybrid: Adjustable using selective assembly

Front Wheel Drive Transmission

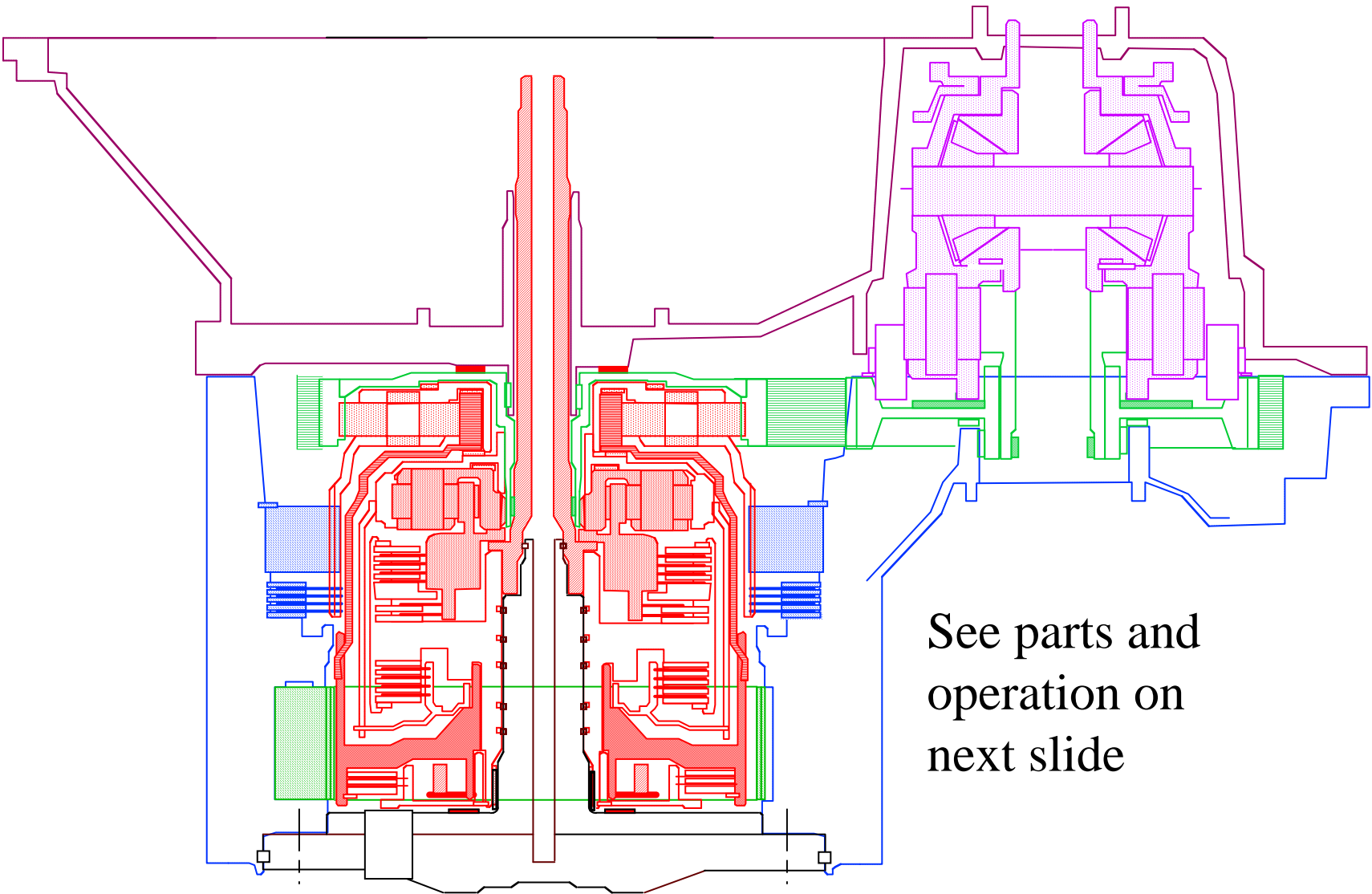

See parts and
operation on
next slide

Transmission Parts

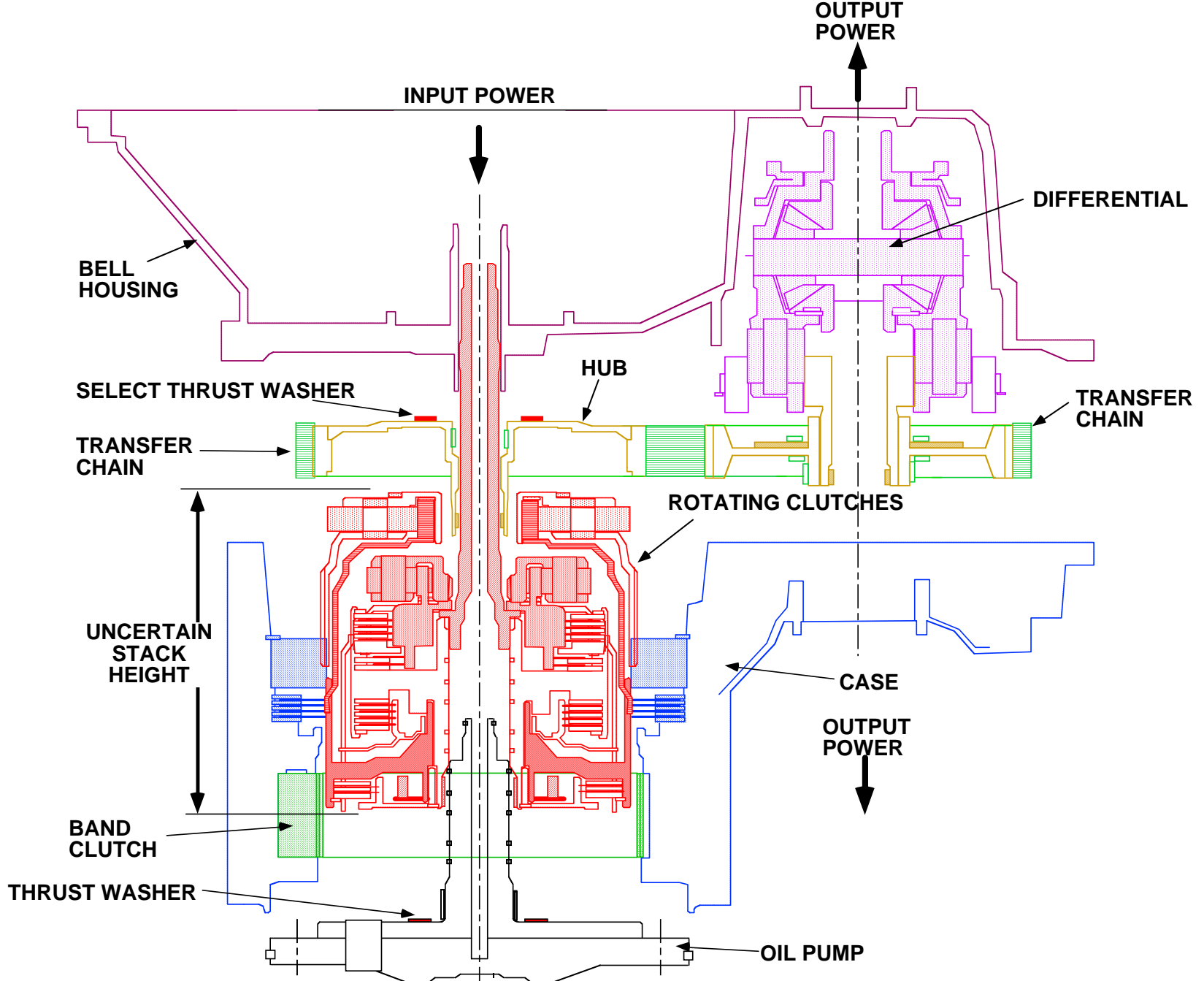

How Oil Pressure Gets to Pistons

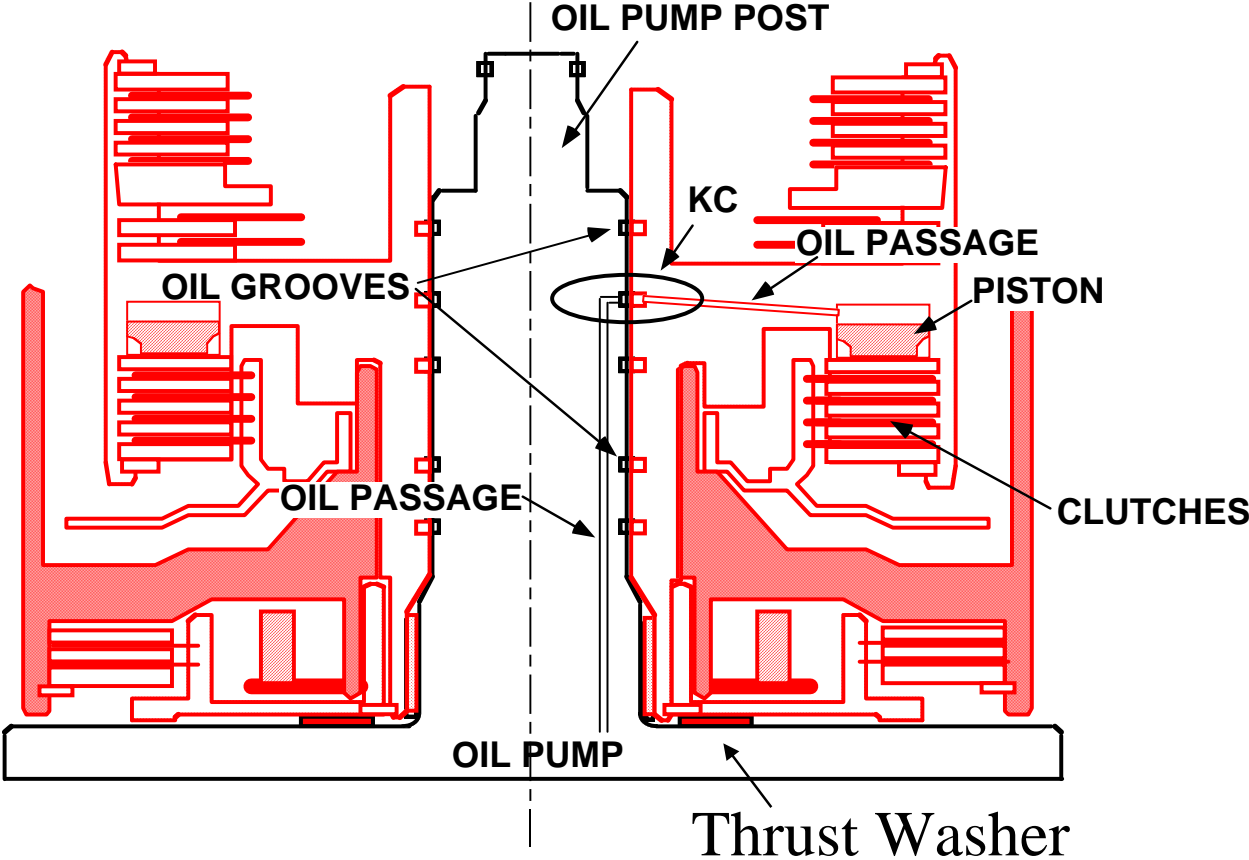

Select Washer Drives Assembly Sequence

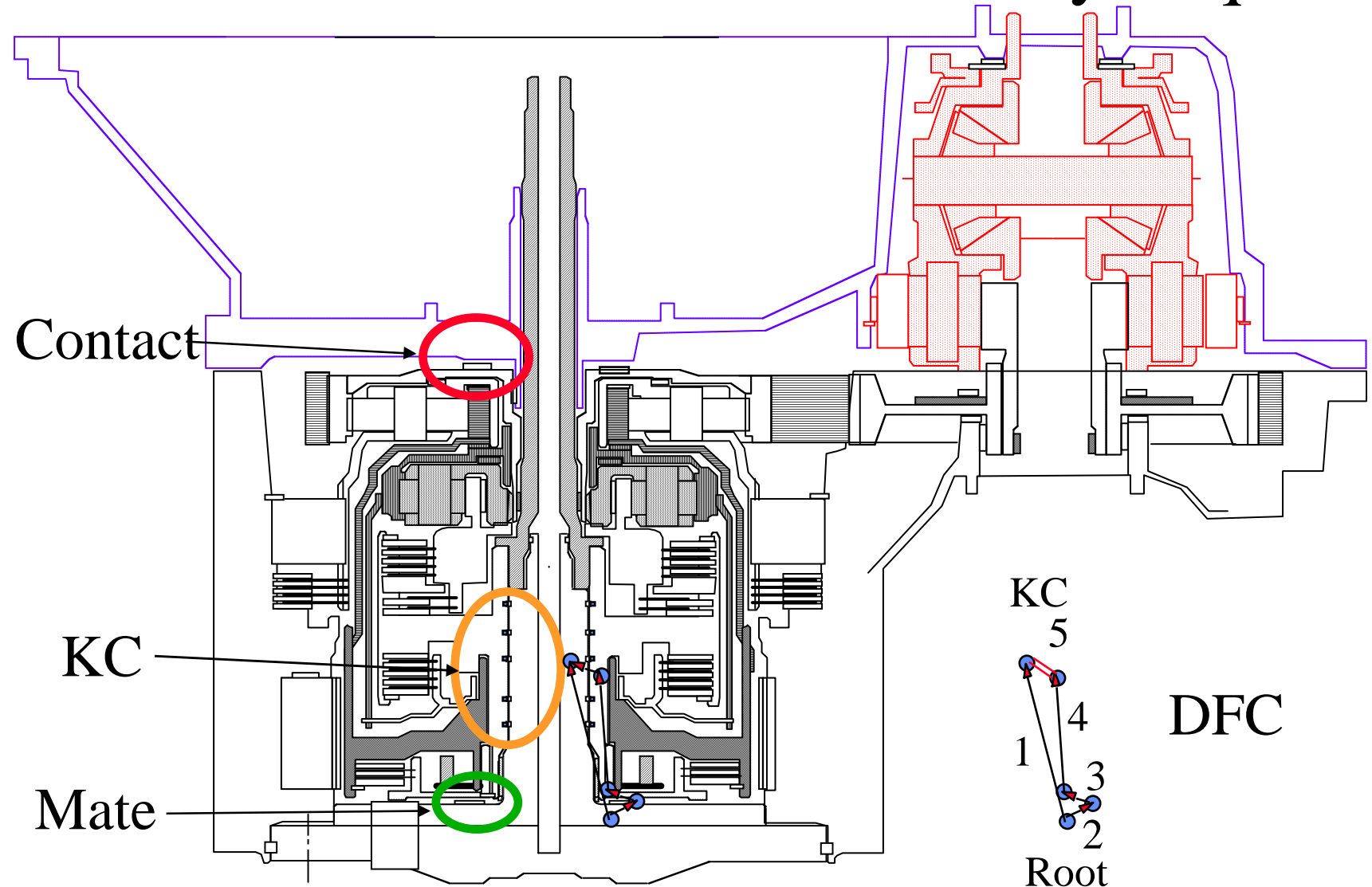

Type 1 and Type 2 Assemblies - 3

- Required assembly sequence is
 - join the mates first
 - join the contacts second
 - the Neon problem
- In type 1 assemblies, it is usually enough to make each part well; assembly means “snapping” the mates together by mating the features
- In type 2 assemblies part accuracy is not enough because the parts do not mate just to each other but instead need adjustments or fixtures, which contribute additional errors

From Parts to Assemblies...

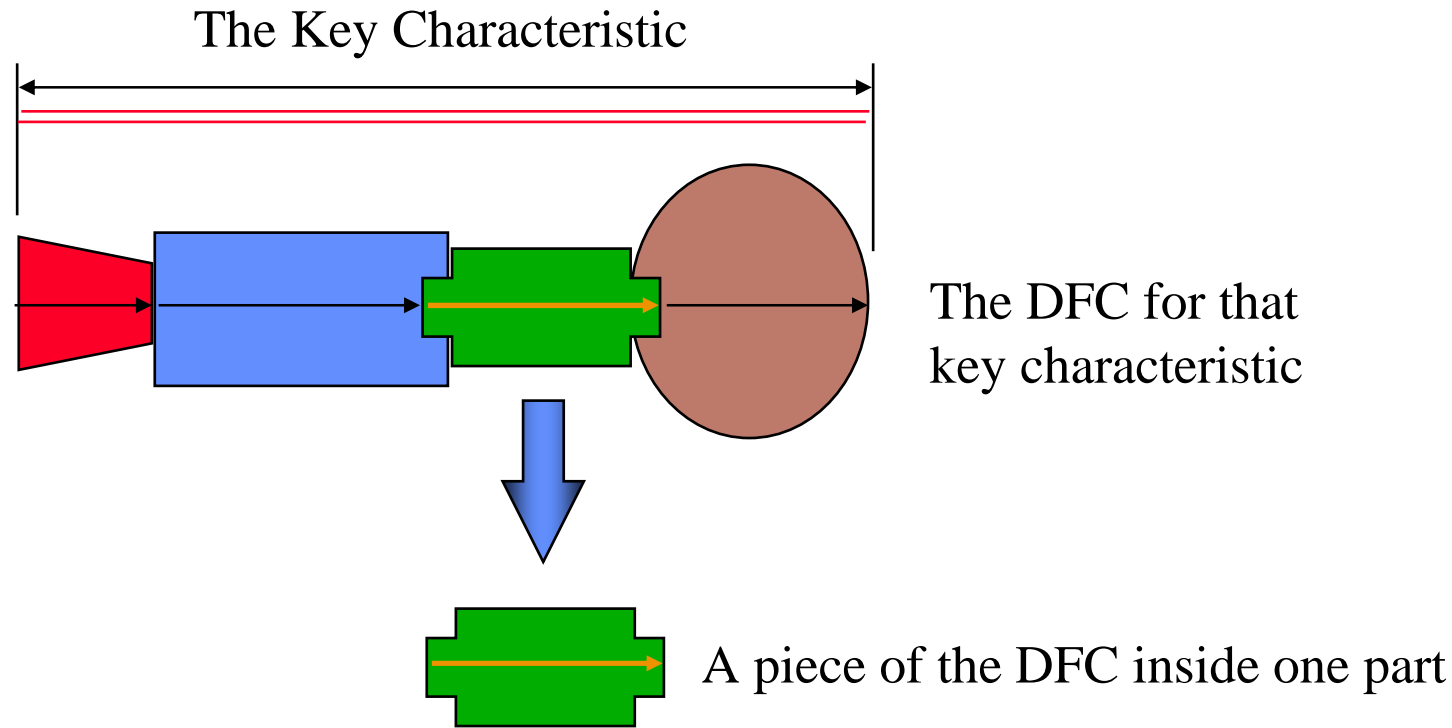

Each piece of the DFC inside a part is a DFC, too. Note that it joins features that are **by definition** under exact constraint with respect to each other as long as the parts are rigid or are not distorted by locked-in stresses.

Example - Car Floor Plan - A Type-2

The dimension to be controlled (the Key Characteristic or KC) is the width L of the floor pan

Image removed for copyright reasons.

Source:

Figure 8-13 in [Whitney 2004] Whitney, D. E.

Mechanical Assemblies: Their Design, Manufacture, and Role in Product Development.

New York, NY: Oxford University Press, 2004. ISBN: 0195157826.

liaison diagram

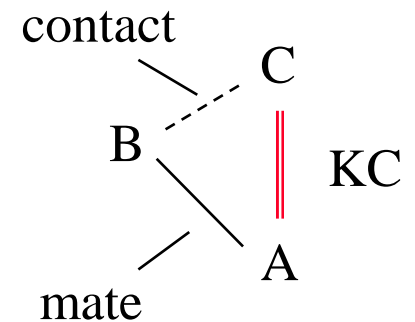

First Candidate Datum Flow Chain

Step 1

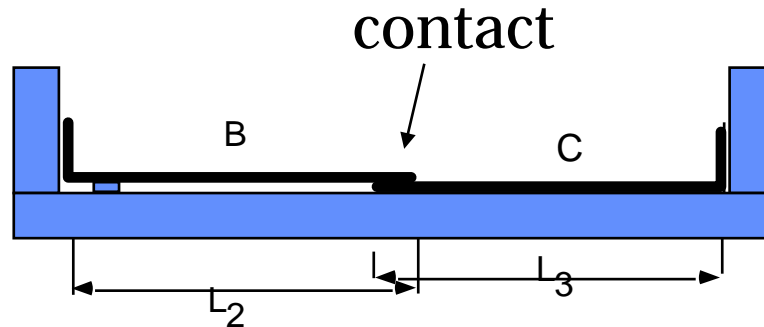

Step 2

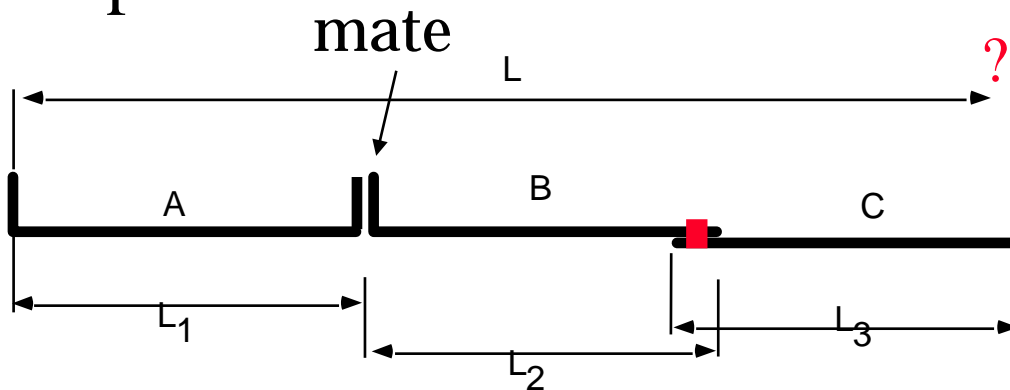

Datum Flow Chain

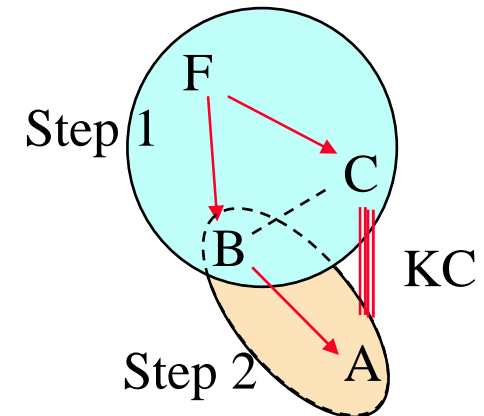

If there is some uncertainty in the shape or size of part A, this assembly process may not yield the correct overall size.

Second Candidate Datum Flow Chain

Step 1

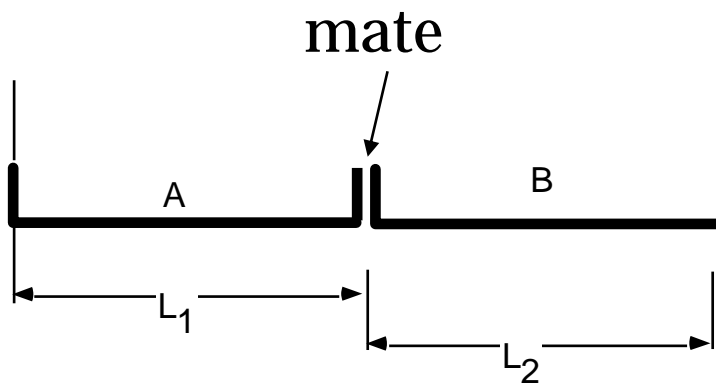

Datum Flow Chain

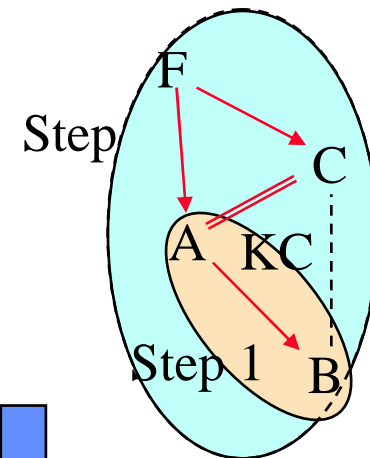

Step 2

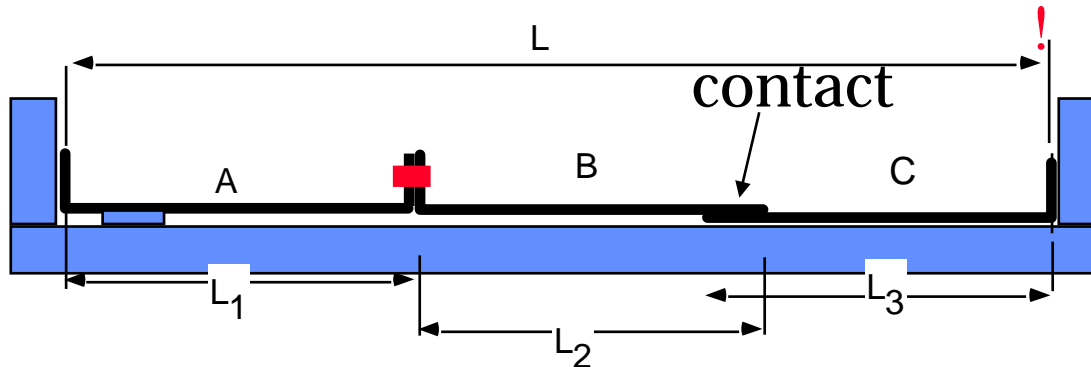

This DFC directly controls the delivery of the KC and is likely to be better but it may be impossible, in which case another assembly sequence may be needed

Properties of DFC

- No loops are allowed (else over-constraint?)
- In each DFC there is one root node with only outgoing arcs
- Every joint where the DFC passes is a mate
- Sum of DOFs constrained = 6 - designed freedom
- Incoming arcs are labeled with number of DOFs constrained or names of directions constrained
- DFCs also contain information on the type of mating feature and the amount of constraint applied by that feature

Example Assembly

Controls air flow to engine via
accelerator pedal cable

Reports throttle opening to ECM

Image removed for copyright reasons.

Source:

Figure 8-37 in [Whitney 2004] Whitney, D. E. *Mechanical Assemblies: Their Design, Manufacture, and Role in Product Development*. New York, NY: Oxford University Press, 2004. ISBN: 0195157826.

Throttle Body

Example Assembly

Images removed for copyright reasons.

Source:

Figure 8-38 in [Whitney 2004] Whitney, D. E. *Mechanical Assemblies: Their Design, Manufacture, and Role in Product Development*. New York, NY: Oxford University Press, 2004. ISBN: 0195157826.

Alternate DFCs for Throttlebody

Images removed for copyright reasons.

Source:

Figure 8-41 in [Whitney 2004] Whitney, D. E. *Mechanical Assemblies: Their Design, Manufacture, and Role in Product Development*. New York, NY: Oxford University Press, 2004. ISBN: 0195157826.

3D DFC/Tolerance Analysis

- We need to find a chain of mates from one side of a KC to the other
- The designer should do this
- In 3D it gets interesting because
 - different directions may have different chains
 - The same feature may be a mate in one direction and a contact in another direction
 - A new symbol is needed: ----->
 - It is both a mate and a contact, depending on the direction

Rules for Drawing DFCs

- Draw the liaison diagram for the assembly
- Choose one of the KCs and identify the dof or dofs that are involved
- Identify the base part or origin for the DFC
 - This should be a part that provides location for other parts that are involved in the KC
- Label the liaisons of the base part with arrows pointing out

Rules 2

- For each part at each end of the KC, label the liaisons with arrows pointing toward the part
- Label each of these liaisons with the dof that need to be constrained in order for the KC to be delivered, as well as those needed to provide proper constraint
- Assume temporarily that the part or parts at the other end of each of these arrows is properly constrained
- Think up an assembly feature joining the KC end part and each of its immediate neighbors that is capable of constraining the required dof

Rules 3

- Remove the assumption that the previous part was properly constrained, and figure out how to constrain it by repeating the above process for it
- Proceed backwards in this fashion until you reach the base part, which is always assumed to be properly constrained
- If full constraint cannot be provided all along the chain just by using part-to-part mates, then fixtures (temporary parts) have to be added

Rules 4: Separating the DFC into Individual KC Directions

- Choose a KC and one of its dof
- Choose a part at one end of this KC
- Identify the mate or mates on this part that are needed to constrain the chosen dof
 - The best way to do this is with Screw Theory
 - Other than that, you have to use high school geometry and geometric reasoning
- Erase liaisons to the chosen part that do not carry these dof
- Continue in this fashion until you reach the base part
- Repeat for the part at the other end of the KC

Building a Stapler DFC

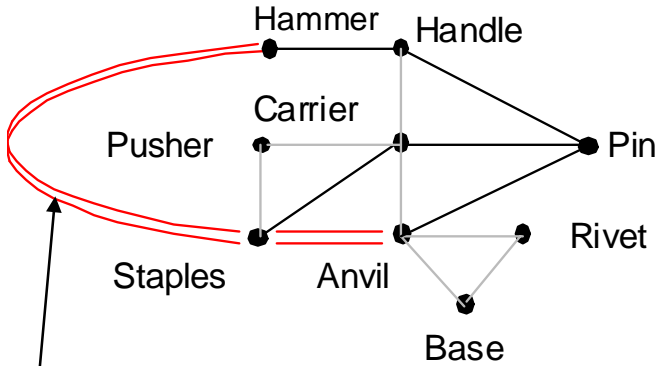

The KC requires 5 dof

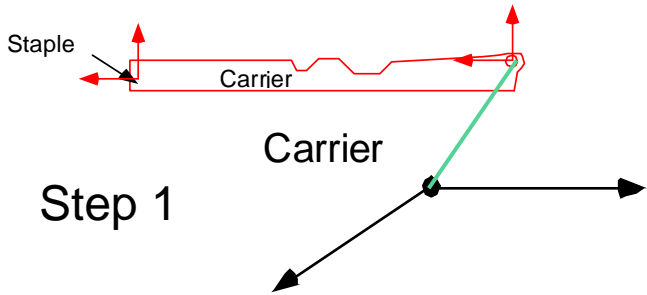

Step 1

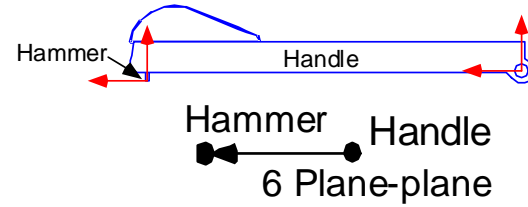

Step 2

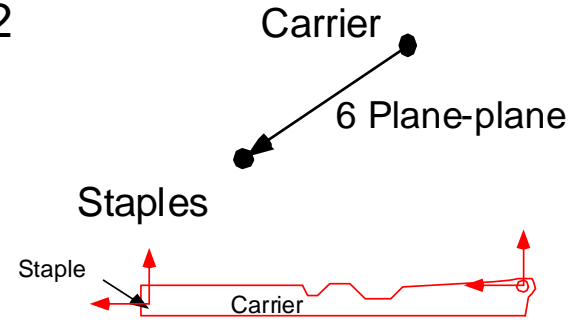

Step 3

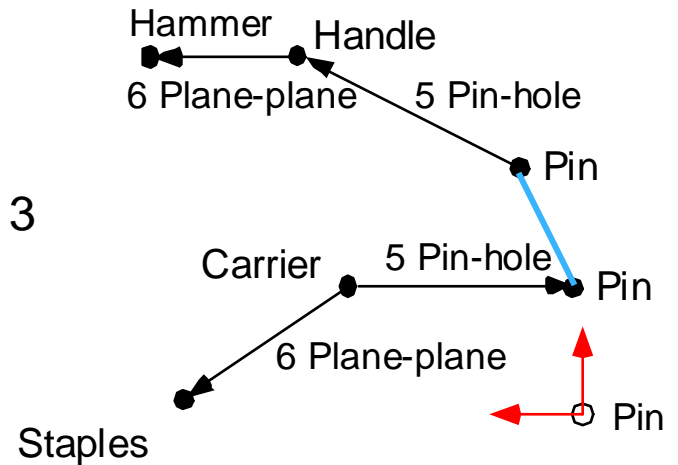

Door Assembly

Image removed for copyright reasons.

Source:

Figure 8-42 in [Whitney 2004] Whitney, D. E. *Mechanical Assemblies: Their Design, Manufacture, and Role in Product Development*. New York, NY: Oxford University Press, 2004. ISBN: 0195157826.

GM and Ford Hinge Mounting

Images removed for copyright reasons.

Source:

Figure 8-47 in [Whitney 2004] Whitney, D. E. *Mechanical Assemblies: Their Design, Manufacture, and Role in Product Development*. New York, NY: Oxford University Press, 2004. ISBN: 0195157826.

GM Method

Ford Method

GM Door Mounting to Car

Images removed for copyright reasons.

Source:

Figure 8-47 in [Whitney 2004] Whitney, D. E. *Mechanical Assemblies: Their Design, Manufacture, and Role in Product Development*. New York, NY: Oxford University Press, 2004. ISBN: 0195157826.

Ford Door Mounting to Car

Images removed for copyright reasons.

Source:

Figure 8-47 in [Whitney 2004] Whitney, D. E. *Mechanical Assemblies: Their Design, Manufacture, and Role in Product Development*. New York, NY: Oxford University Press, 2004. ISBN: 0195157826.

DFCs for Car Doors

Liaison Diagram

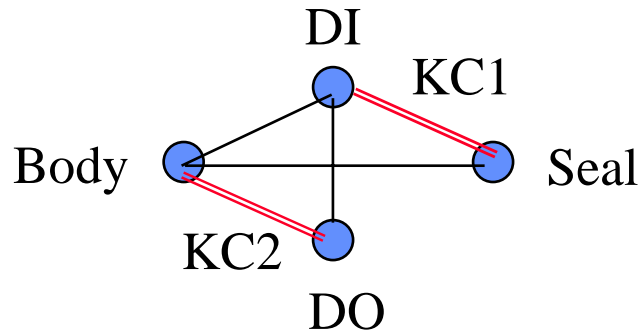

GM Process

DFC if this were a Type-1

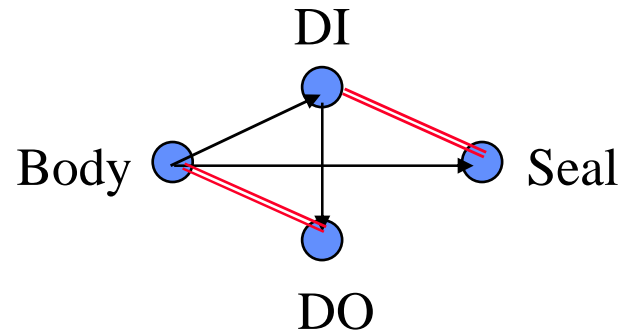

Ford Process

Image removed for copyright reasons.

Source:

Figure 8-49 in [Whitney 2004] Whitney, D. E.

Mechanical Assemblies: Their Design, Manufacture, and Role in Product Development.

New York, NY: Oxford University Press, 2004. ISBN: 0195157826.

Images removed for copyright reasons.

Source:

Figure 8-52 in [Whitney 2004] Whitney, D. E.

Mechanical Assemblies: Their Design, Manufacture, and Role in Product Development.

New York, NY: Oxford University Press, 2004.

ISBN: 0195157826.

KC Delivery Chains for Each KC - GM Method

Image removed for copyright reasons.

Source:

Figure 8-50 in [Whitney 2004] Whitney, D. E. *Mechanical Assemblies: Their Design, Manufacture, and Role in Product Development*. New York, NY: Oxford University Press, 2004. ISBN: 0195157826.

KC Delivery Chains for Each KC - GM Method

Seal KC

Images removed for copyright reasons.

Source:

Figure 8-51 in [Whitney 2004] Whitney, D. E. *Mechanical Assemblies: Their Design, Manufacture, and Role in Product Development*. New York, NY: Oxford University Press, 2004. ISBN: 0195157826.

Door Process Comments

- The designer should create these DFCs, with participation of manufacturing engineers
- The chain is the thing to manage, not the parts or the fixtures separately
- The chain will never exist all at once, in one place, at one time. This makes management hard.
- When a fixture like F1 sets door inner to door outer, the parts “remember” the positioning and its errors
- The DFC captures organizational interactions

GM Door DFC with Organizations

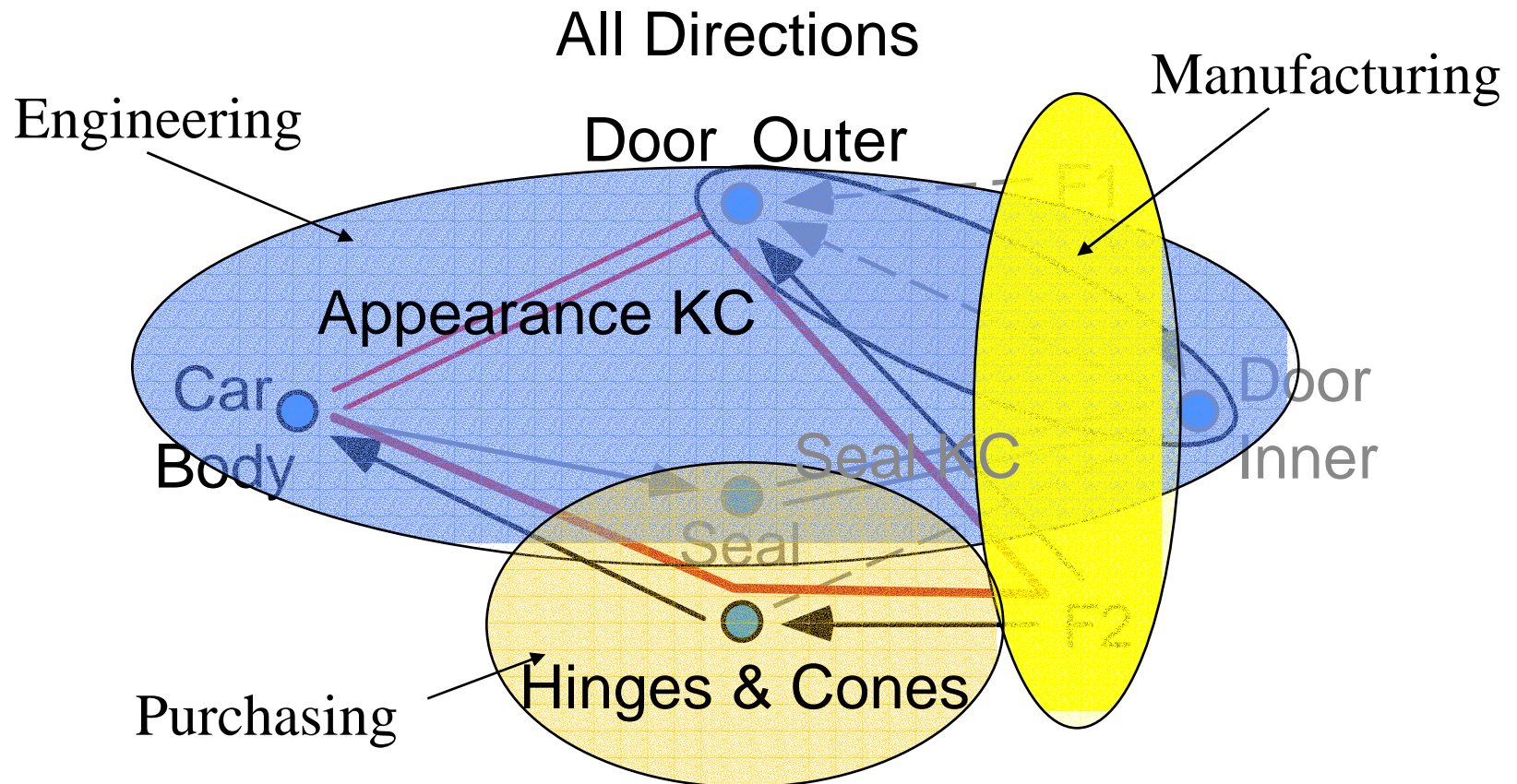

767 Wing Skin Subassembly

Image removed for copyright reasons.

Source:

Figure 8-64(a) in [Whitney 2004] Whitney, D. E. *Mechanical Assemblies: Their Design, Manufacture, and Role in Product Development*. New York, NY: Oxford University Press, 2004. ISBN: 0195157826.

Assembly Using a Fixture - Type-2

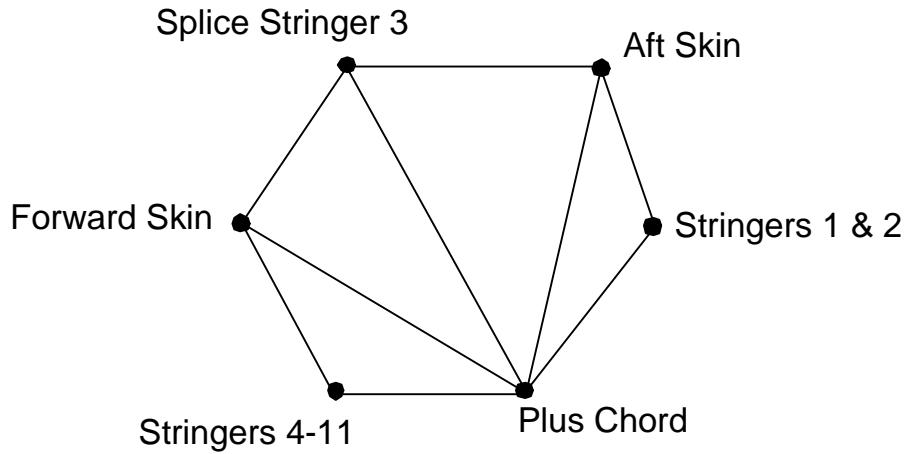

Liaison Diagram

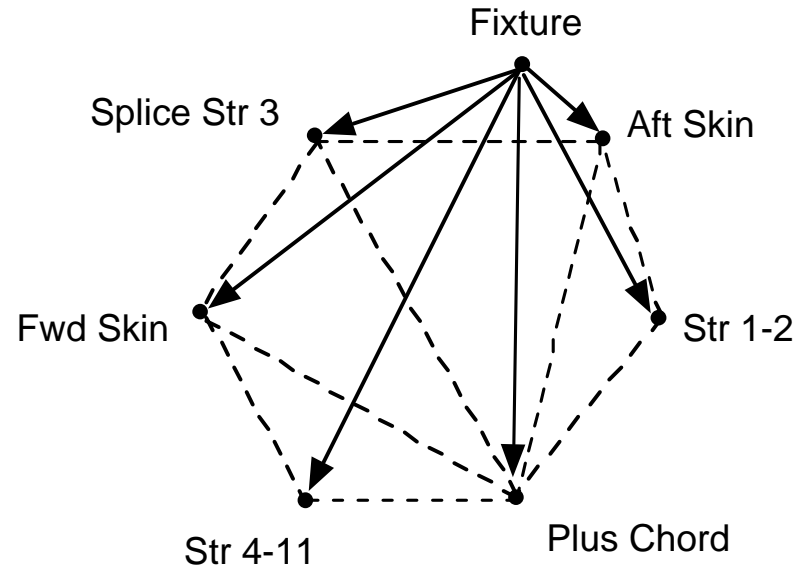

Datum Flow Chain

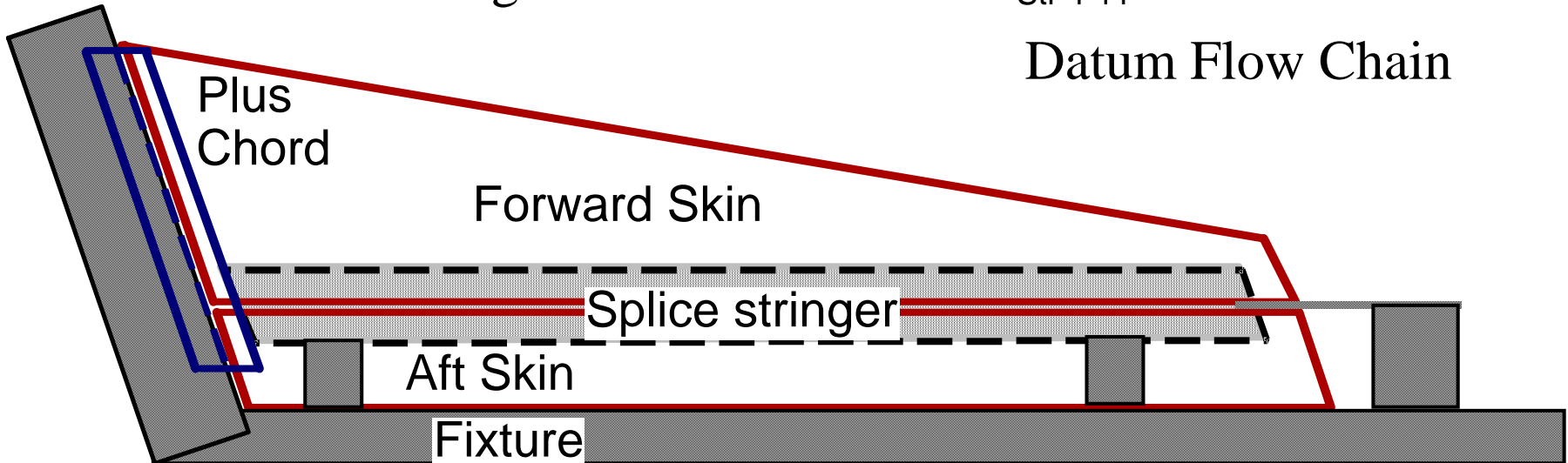

Assembly Using Features on the Parts - Type-1

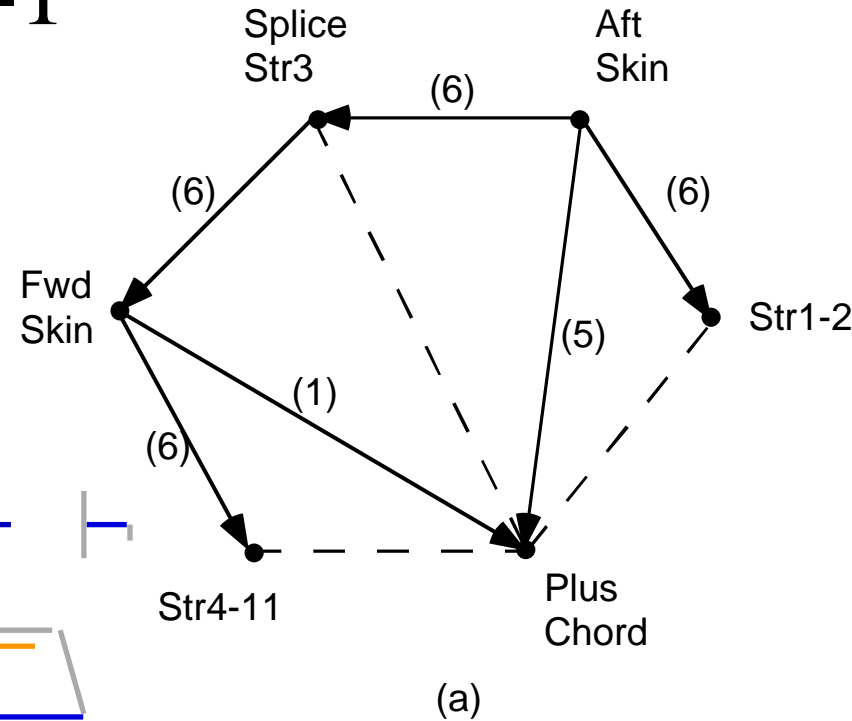
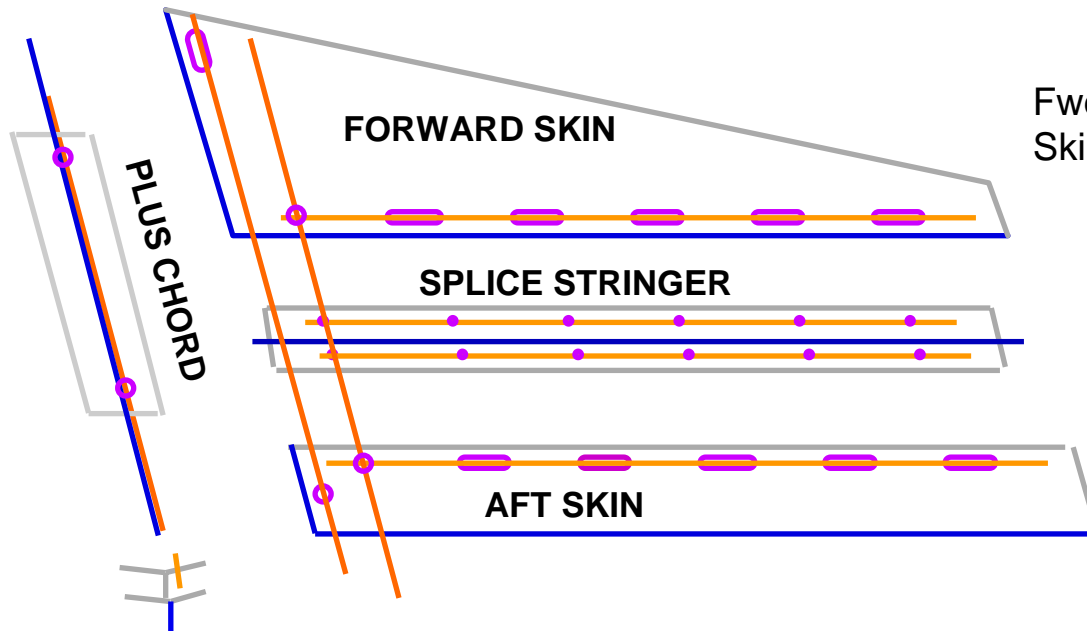

- ASSEMBLY LEVEL DATUMS
- PART LEVEL DATUMS
- MATING FEATURE (SLOT)
- MATING FEATURE (HOLE)

Datum Flow Chain for Car Front End

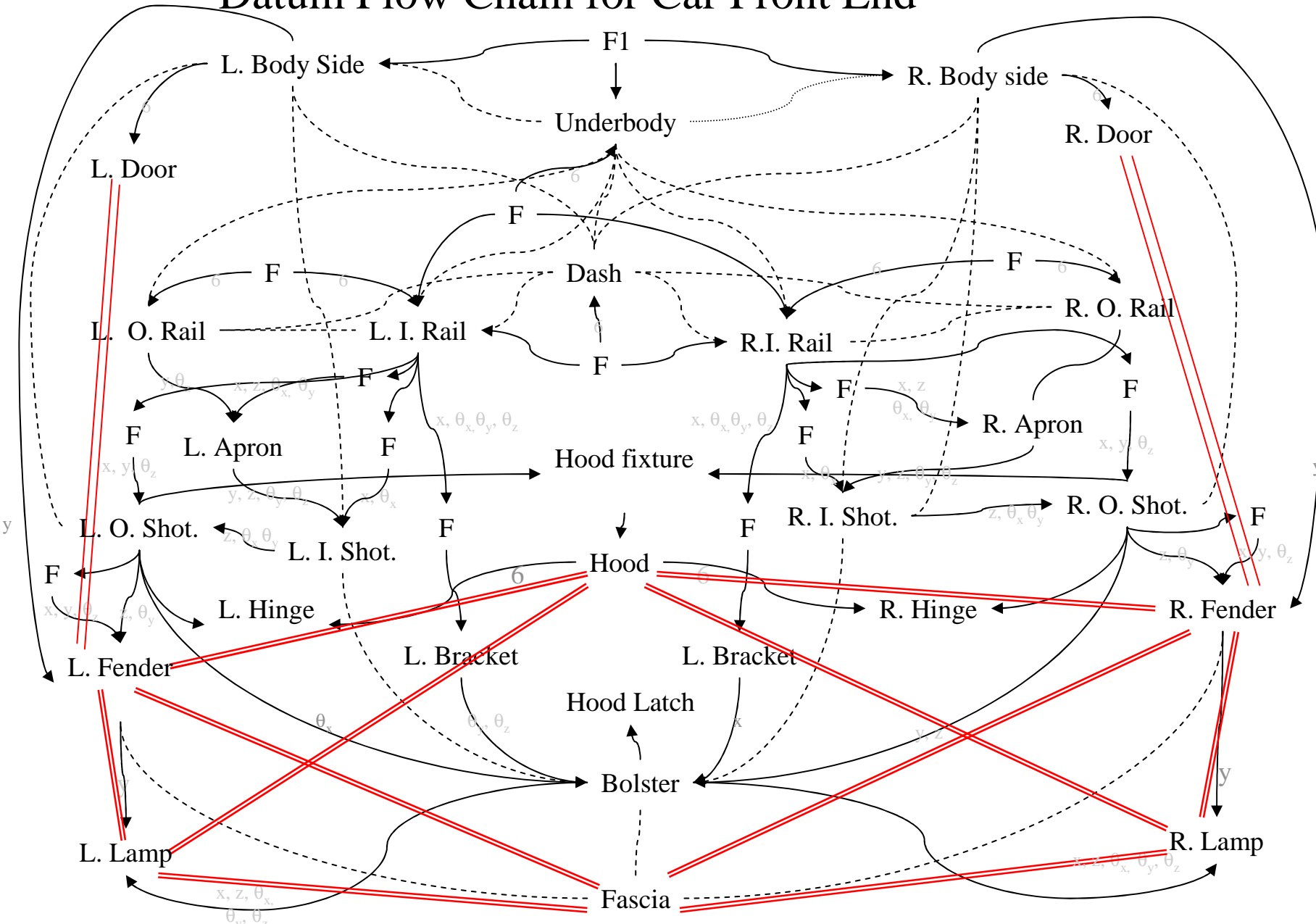

DFC for Car Doors

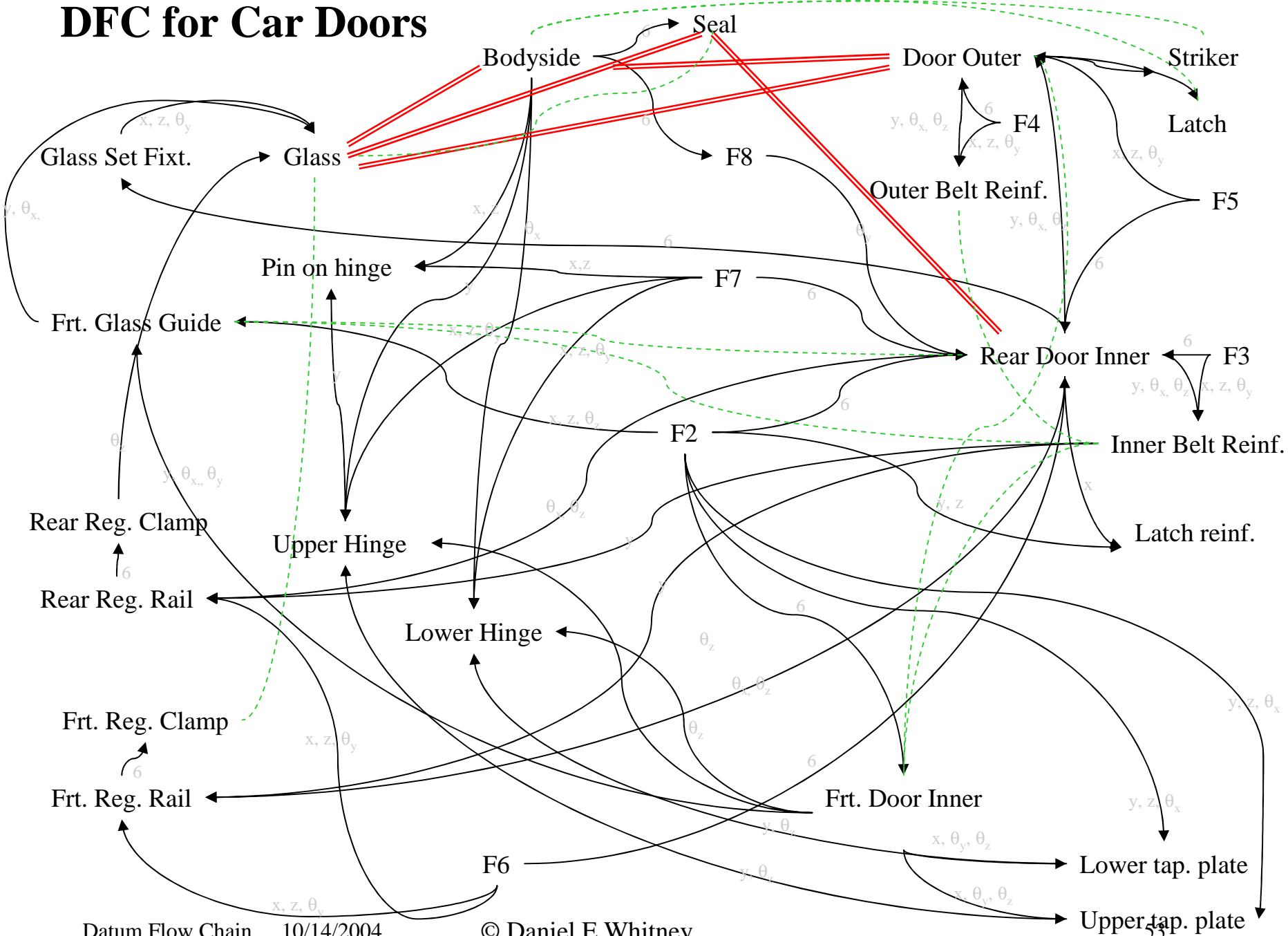

Assembly Precedence Constraints

- Contact Rule

“Permissible subassemblies are connected subgraphs in a DFC”

In other words, subassemblies with only contacts between parts are not permitted, so all mates must be completed before any contacts are completed

- Constraint Rule

“Subassemblies with incompletely located parts are not permitted”

Every subassembly must have fully located parts, so all incoming mates must be done simultaneously ($a \geq b$ & $b \geq a$)

- If necessary, a fixture (considered to be a “part”) may be added to help obey the rule

- A practical consequence is that assembly sequences will build the DFC from the root out

Variation propagation analysis using DFC

- Tolerance chain for any KC can be derived by traversing the DFC
- Since DFC is a directed acyclic graph, there is a unique tolerance chain for any KC
- For type-1 assemblies, all assy sequences will have identical tolerance chains and variation
- Type-2 assemblies are process-determined, hence have to evaluate each process and its fixtures

DFC and Constraint

- Over-constraint can show up if the DFC has
 - A branch followed by a merge
 - A loop (should not occur)
 - A mate consisting of multiple features
- You need to check each case individually

DFCs, Tolerances, and Constraint

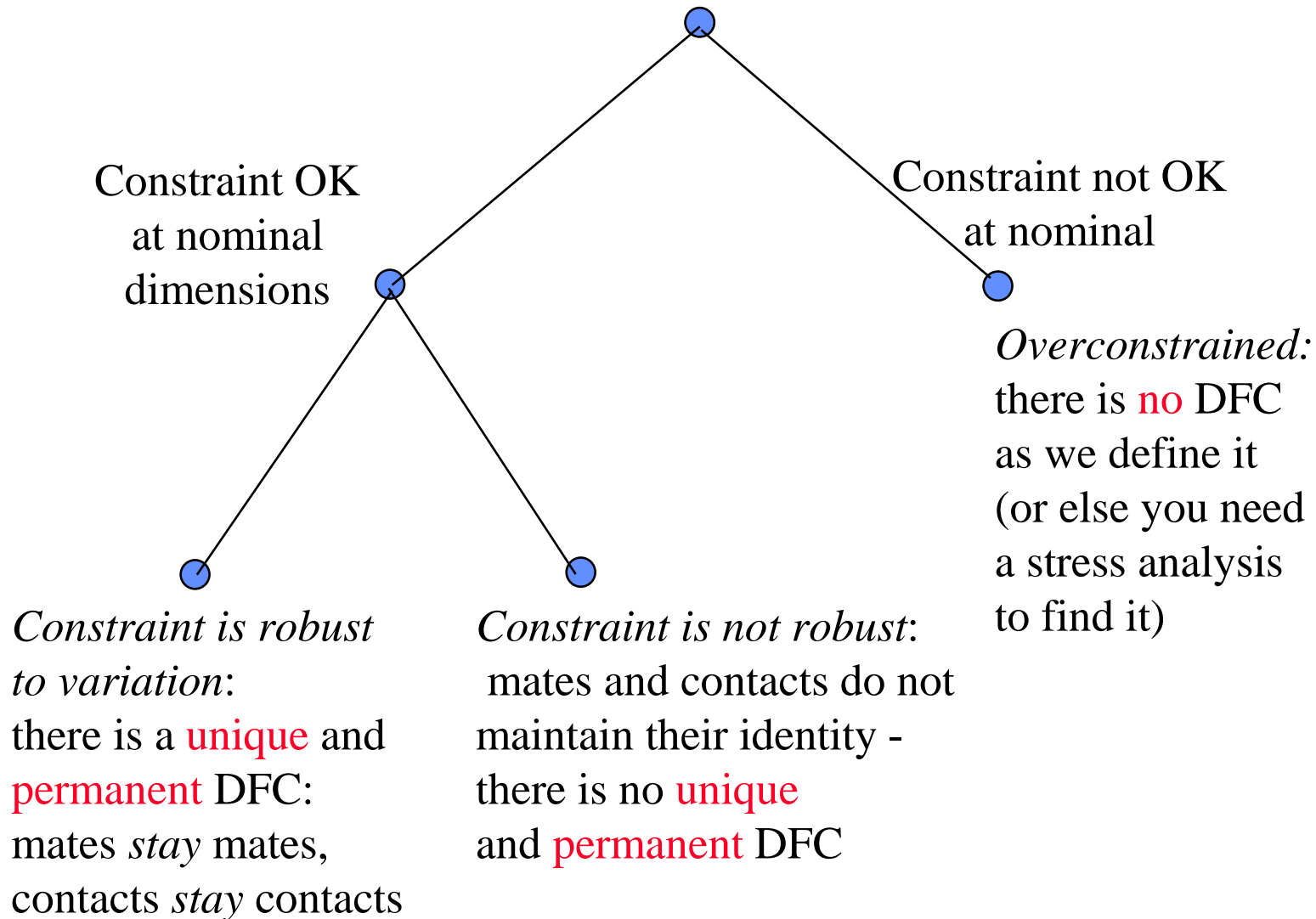

Assembly Design 1: Nominal Design Phase

- Identify the KCs
- Decide type 1 vs type 2 (*could be revised)
- Identify constraint plan plus fixtures and adjustments if any*
- Define the DFCs, features, mates, and contacts for each KC*
- Check for proper constraint
- Find feasible assembly sequences and choose one*
- Check for KC conflict
- See if different assembly sequence removes KC conflict

Assembly Design 2: Variational Design Phase

- Analyze tolerances to see if DFC is robust
- Analyze tolerances to see if KCs are delivered
- See if a different assembly sequence gives better variation
- Revise * as necessary

Design Procedure for Properly Constrained Assemblies

Image removed for copyright reasons.

Source:

Figure 8-58 in [Whitney 2004] Whitney, D. E. *Mechanical Assemblies: Their Design, Manufacture, and Role in Product Development*. New York, NY: Oxford University Press, 2004. ISBN: 0195157826.

Summary of Assembly Theory - Nominal Design

- An assembly is a set of parts that deliver their quality, as defined by the KCs, as a result of achieving proper geometric relationships between the parts
- Designing an assembly means designing these relationships in terms of one DFC per KC
 - The DFC documents the nominal constraint relationships
 - The DFC passes from part to part via mates
- The nominal design is a constraint structure onto which we paste parts
- Assembly features generate and enforce the constraint relationships at each mate

Summary of Assembly Theory - Variation Design

- Tolerances should assure the robustness of the DFC
- KC delivery is verified by a tolerance analysis of each DFC. Variation passes through the mates.
- Tolerances on parts flow from tolerances on the KCs
- Type -1 assembly-level variation comes from part variations
- Type - 2 assembly level variation can be altered by adjustments to the assembly process

Image removed for copyright reasons.

Source:

Figure 8-59 in [Whitney 2004] Whitney, D. E. *Mechanical Assemblies: Their Design, Manufacture, and Role in Product Development*. New York, NY: Oxford University Press, 2004. ISBN: 0195157826.