

Topic 2 Creation of Ideas

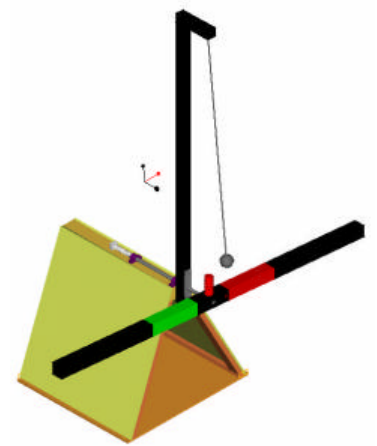

Topics

- Thought Processes
- Experimentation
- Drawing
- Research
- Writing
- Analysis
- Evolving Ideas

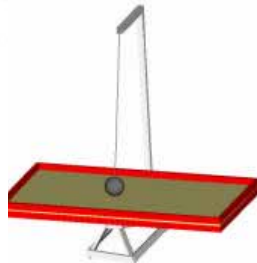
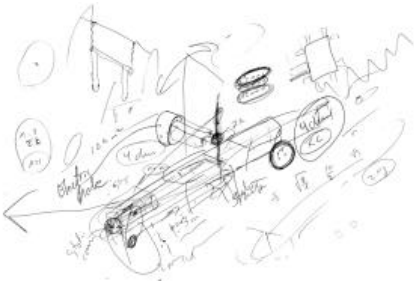

Thought Processes

- For all the methods discussed here to help generate ideas, several thought processes can be used as catalysts
 - Systematic Variation
 - Consider all possibilities
 - Persistent Questioning
 - Continually ask “Who?”, “What?”, “Why?”, “Where”, “How?”
 - Reversal: Forward Steps
 - Start with an idea, and vary it in as many ways as possible to create different ideas, until each gets to the end goal
 - Also called the *method of divergent thought*
 - Reversal: Backwards Steps
 - Start with the end goal and work backwards along as many paths as possible till you get to the beginning
 - Nature’s Way
 - How would nature solve the problem?
 - Exact Constraints
 - What are the minimum requirements

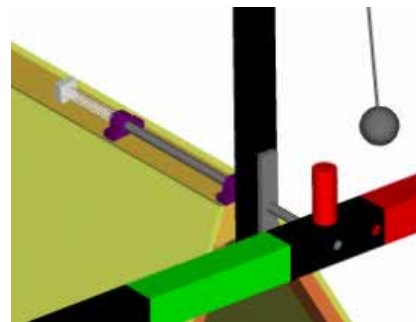

Thought Processes: *Systematic Variation*

- Consider all possibilities:
 - Energy: How can it be applied, generated, stored?
 - Mechanical: springs, flywheels...
 - Hydraulic: piston, bladder, reservoir, propeller...
 - Electrical: line source, battery, capacitor, magnet, optical...
 - Material:
 - State: solid, liquid, gas
 - Behavior: rigid, elastic, plastic, viscous
 - Form: bar, sheet, powder...
 - Motions:
 - Type: fixed, linear, rotary
 - Nature: uniform, non-uniform, transient
 - Direction & Magnitude
 - Controls:
 - Passive
 - Active
- AND all combinations of the above!
- Mathematical models of systems are invaluable
 - Sensitivity studies can easily be conducted

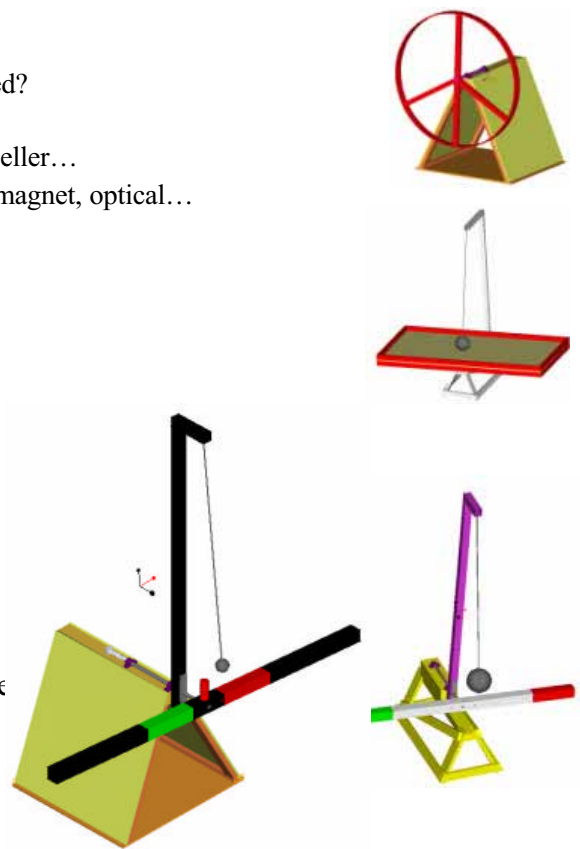

Thought Processes: *Reversal*

- Being able to rapidly switch between the methods of Forward Steps and Backward Steps is an invaluable skill
 - Example: Given line length equalities indicated by the colors, How would you prove that the yellow line is the perpendicular bisector of the purple and red lines?
 - Never be afraid to add your own sketching to a problem that is given you
 - The thin red and blue lines and vertex labels were added!
 - If you do not rapidly see how to move forward, try going backwards!

As ξ

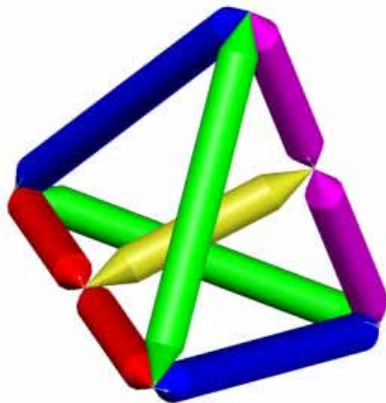

After user clarifying ξ

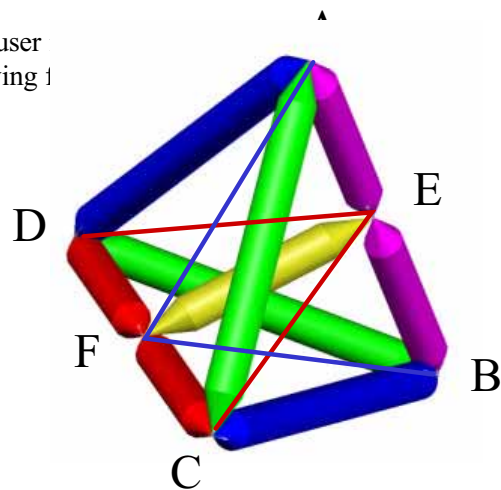

Experimentation

- Playing With Parts
- Sketch Models
- Bench Level Experiments
- Bench Level Prototypes
- Identifying Risky Ideas

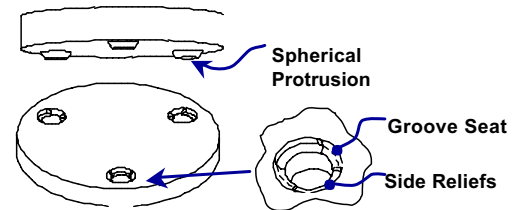
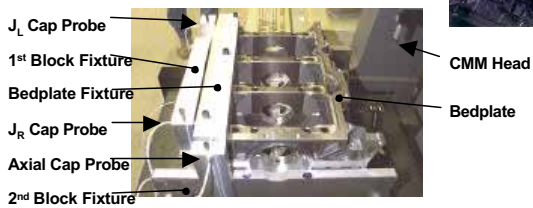
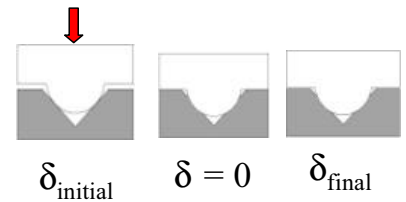
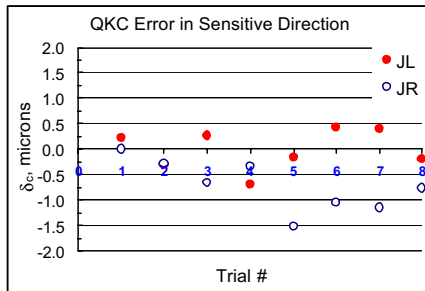
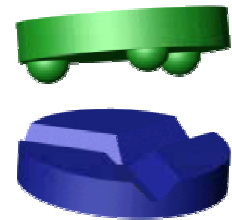
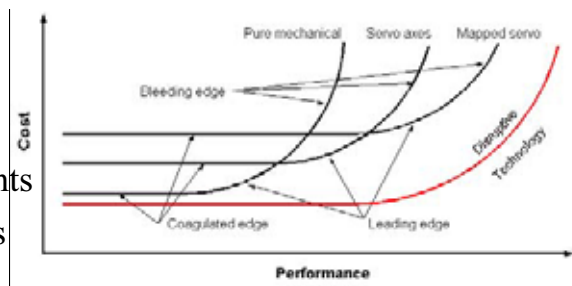

Experimentation: *Playing with Parts*

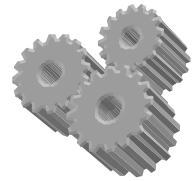

- Lay out all the materials you have (physically or information sheets) in front of you and play with them, let them talk to you, what are their limits, how have others used them...
 - Place components on various places on HAL to obtain a physical feel for how they might fit.....
 - Move the table and feel its motions....
- With a “competing” partner “drive” imaginary machines with your hands to represent possible motions
 - Mock fantasy competitions can highlight strategies

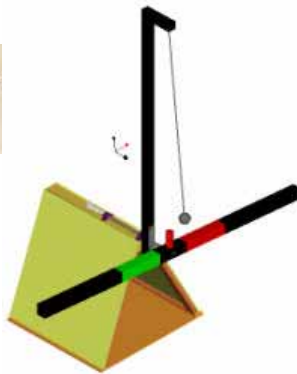



Experimentation: *Sketch Models*

- Sketch models are made from simple materials (e.g., cardboard, foam, hot-melt-glue, tape, string) and they allow you to literally “play” with possible **strategies**
 - Later, when you have a concept developed, they enable you to “test drive” your machine **concept** around the table
 - In the “real world” where designs are often very complex, sketch models are still often important “proof of concept” aids
 - They can be invaluable sales tools!
- A *Sketch-Model-Derby* is an invaluable way to test ideas, with minimal risk of time and materials



=

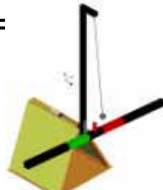

>



=>



Experimenting: *Bench Level Experiments*

- Experiments to test function, force, friction, speed, are a vital part of the design process
 - Analysis is potentially the quickest way to verify an idea
 - Analysis inexperience or uncertainty can lead to analysis paralysis
 - Analysis paralysis is most often relieved by a simple experiment

– Example:

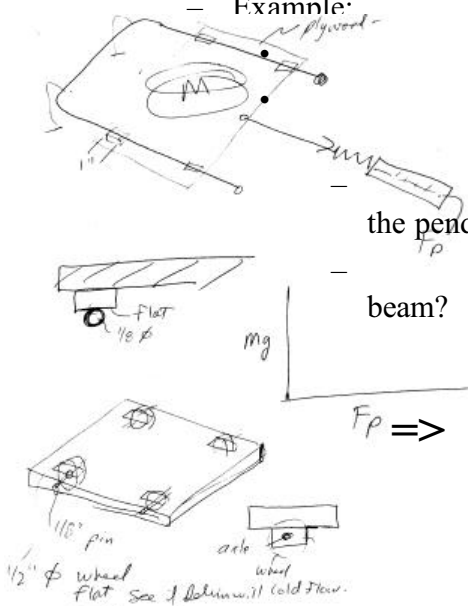

– how to pull the pendulum to your side
 – how to use a motor to the beam and tie a string around the pendulum
 – how the motor shaft can wind the string up and pull the pendulum over
 – how the string's distance above the beam affect how far over it can pull
 – how to change the position of the string above the beam?

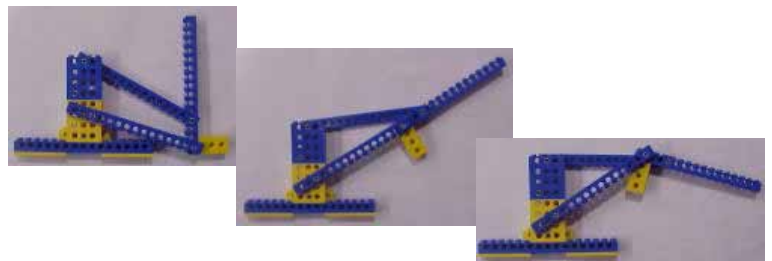

Experimenting: *Bench Level Prototypes*

- Once you get to the concept phase, you may have a risky idea, which if it works, would be awesome
 - A *Bench Level Experiment* is performed to prove the principle of the idea, but when completed it is disassembled
- A *Bench Level Prototype* is designed to ideally be an actual module to test a concept's risky ideas
 - It is a well-designed mechanism, and if it works, is a ready-to-use module for your machine!
 - It often can show you what works and what must be fixed in a module (like the software!)
 - A robot contest example would be to create a vehicle to test its speed and controllability
 - Use modular components, so you can change them to optimize performance
 - E.g. change the gear ratio on a vehicle's drive train

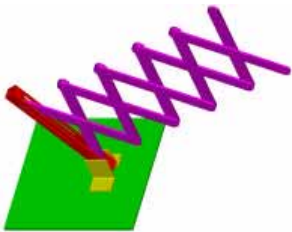

Drawing: *Motion & Force Diagrams*

- It is important to sketch the idea of a strategy without including any mechanical detail
 - Just use arrows to indicate directions of motions
 - Illustrating the motion with mechanism implies a concept
 - Use different colors!
 - You do not want to start implying concept because this could lead you to spend time developing it before you explore enough strategies
 - Time is precious
 - For an illustrative reference, read *If you give a mouse a cookie*

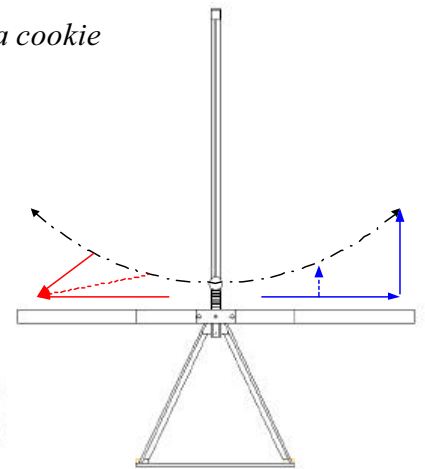
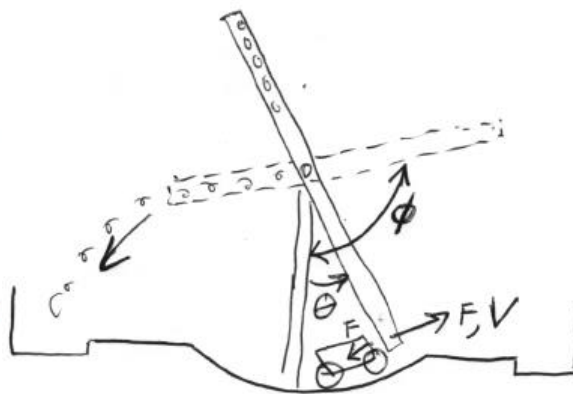
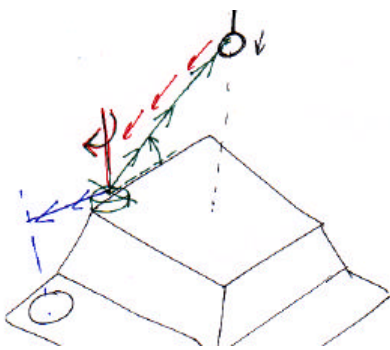

Drawing: *Sketches*

- **Strategies** are sketched with simple arrows to indicate motions
- **Concepts** are sketched showing enough mechanism type and the modules
- Modules are sketched showing component type and the subassemblies
- Subassemblies and components capture detail and primary design intent
- Good sketches and a not so good sketch

Try to sketch in 3D!

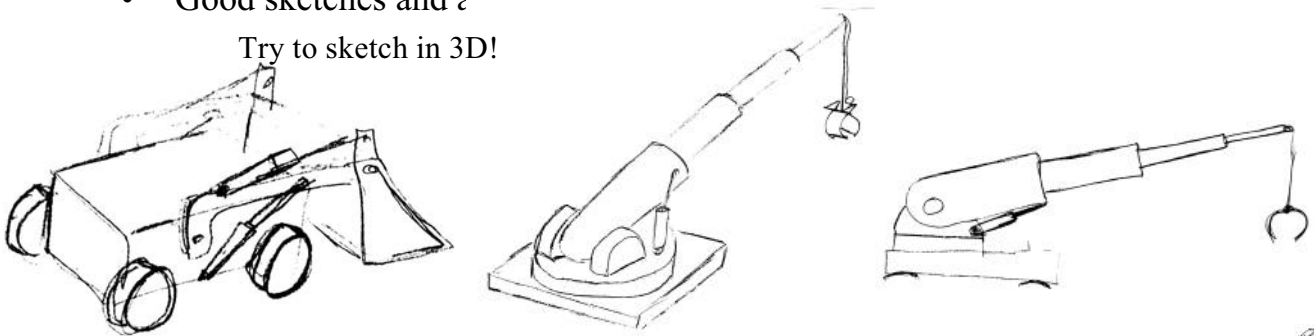

- Pit your sketches against each other in mock battles!

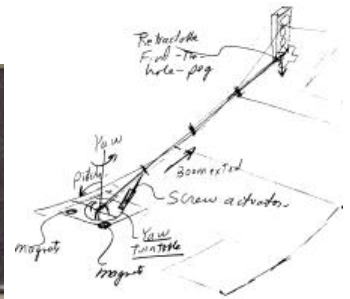
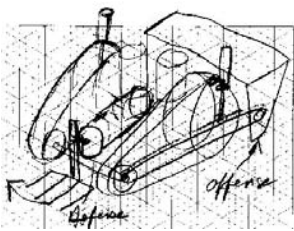

Drawing: *Solid Models*

- Creating a solid model of the environment (Contest table!) lets you build a solid model of your machine, and make sure it will fit!
 - A solid model of the environment lets you take measurements in the middle of the night, to make sure your mechanism will fit, and thus speeds the development process
- A solid model of a concept starts as simple parametric shapes, that will essentially define volumes into which modules must fit
 - Detail is added as the design progresses
- A solid model can serve as a Bench Level Experiment, to illuminate problems and thus help guide analysis

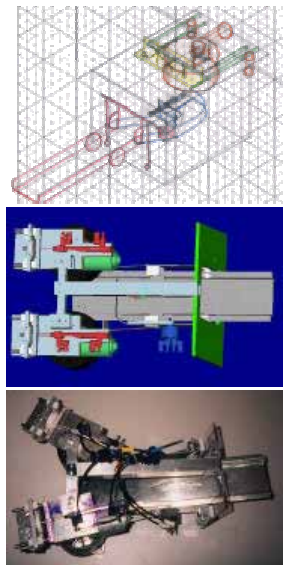

Alex Sprunt's machine

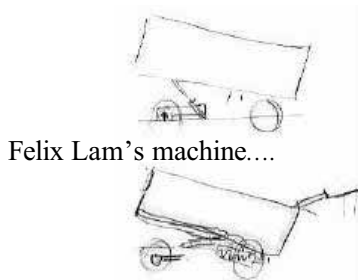

Felix Lam's machine....

© 2000 Alexander Slocum

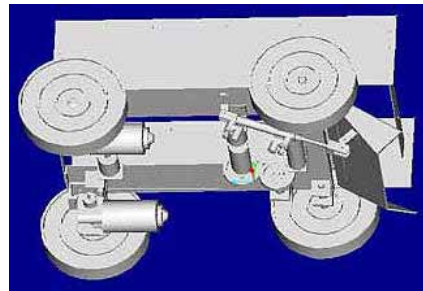

2-13



Research



- Past contests
- The WWW
- Patent searches

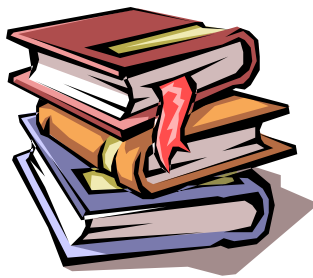

www.bobcat.com



Sound Spa Deluxe Acoustic Relaxation Machine with LCD Alarm ...
 ... Roll from AirCare Therapeutic Products **Sleep Roll** cradles the neck for ... and fits in any **pillow** case. ... **Sound Spa Deluxe Acoustic Relaxation Machine with LCD ...**
www.backbenimble.com/new/pages/homedics/sound_spa_deluxe.htm - 94k - Cached - Similar pages

Sleep Buddy Plus Elite
 ... Roll from AirCare Therapeutic Products **Sleep Roll** cradles the neck for ... and fits in any **pillow** case. ... **Sound Spa Deluxe Acoustic Relaxation Machine with LCD ...**
www.backbenimble.com/new/pages/sleepbuddy/ - 94k - Cached - Similar pages
 [More results from www.backbenimble.com]

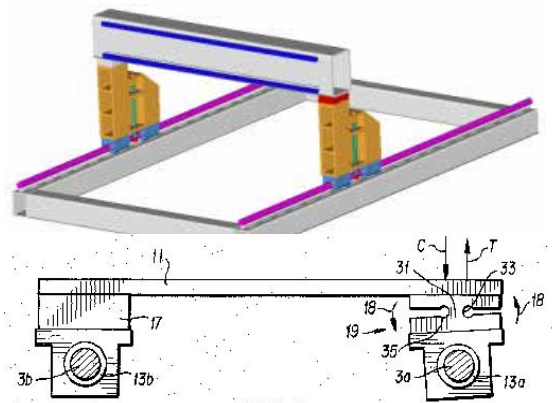

FIG. 3

US Patent 4,637,738

Writing



- Putting it in your own words....
- Lists and Tables
- Narratives
- Poems, raps, ballads...

PROJECT STATUS UPDATE. NOFER TRUNIONS

Work has been proceeding in order to bring to perfection the crudely conceived idea of a machine that will consistently refragitate Nofer Trunions. The current design concept, known as a Turbo Encabulator, supplies inverse reactive current to unilateral phase detractors and thus is capable of automatically synchronizing its internal Cardinal Grammmeters.

The original machine has a base plate of pre-fabulated amulite surmounted by a malleable logarithmic casing in such a way that the two sperving bearings are co-linear with the pentrametric fan. The main winding is of the normal Lotus-O-Delta type, placed into patedermic semi-blode slots in the stator with every seventh conductor being connected by a non-reversible tremic pipe to the differential girdle spring at the upper end of the grammeter. 41 (yes, 41!) manestically spaced grouting brushes are arranged to feed into the rotor slip stream a mixture of high S value phenolbitatol benzene and 5% ruminative tetra tyliodol hexamine. Both these liquids have a specific pericosity given by:

$$P = 2.5 Cn^{6.5}$$

where n is the diethetical retribute of temperature phase disposition, and C is Colomondole's annual grilliage constant. Initially, n was measured with the aid of a metapolar diffractive pilfrommeter, but to date nothing has been found to equal the transcendental hopper dactarcope.

Undoubtedly, the Turbo Encabulator has reached a high level of technical development. It has been successfully used to produce sucratively modified Nofer Trunions in large volumes. In addition, whenever a bardensen scorn motion is required, it may be employed in conjunction with a drawn reciprocating dingle arm to reduce sinusoidal depletion in the Nofer Trunions' bifurdangled hipniscorn.

Believed to be written decades ago by a long-forgotten soul at Phi Kappa Tau fraternity, Rensselaer Polytechnic Institute

Analysis

- Appropriate Analysis
- Scoring Sensitivity
- Time & Motion
- Power & Strength



Sir Isaac Newton (1642 - 1727)

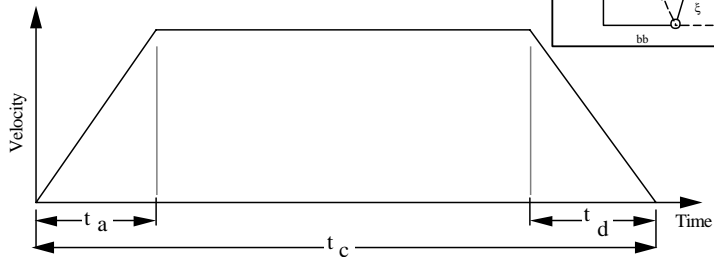
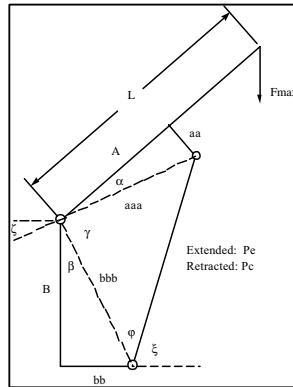
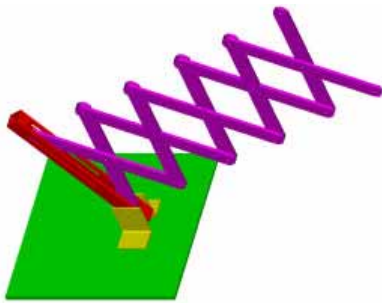

© 2000 Alexander Slocum

2-16



Tim Zue



1997's *Pass The Puck!*

Will Delhagen & Alex Jacobs



2001's *Tiltulator!*

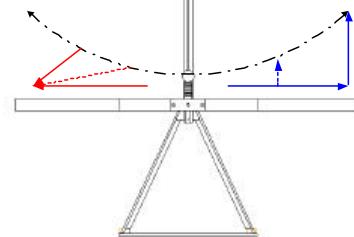

Analysis: *Scoring Sensitivity*

- What gives the most tilt for the least effort:
 - Pendulum?
 - Hockey pucks?
 - Machine?
- What variables affect tilt?
 - Distance from pivot point
 - Weight
 - Force
 - ?
- Answer these questions by writing the equations, and then investigating which are the most sensitive parameters
 - Ask yourself: How can I affect each of these parameters?
- ***Physics is an AWESOME catalyst to help your brain generate ideas***
- ***Analysis is an awesome lens for focusing effort!***

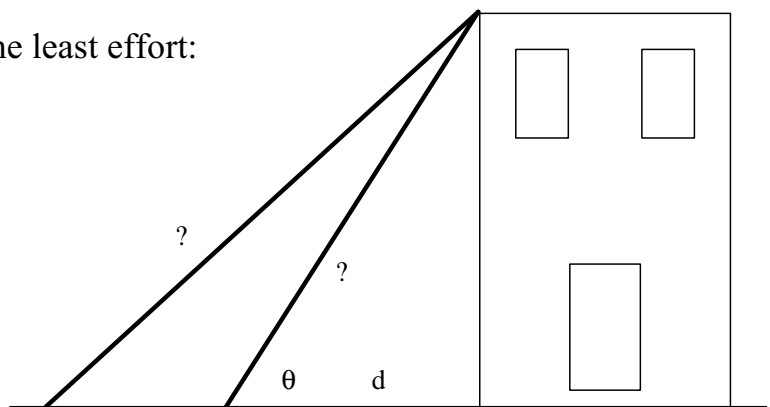

Analysis: *Appropriate Analysis*

- Appropriate Analysis is a **CRITICAL** part of defining a problem’s bounds and generating creative concepts!
 - If $F=ma$ will answer the question, do NOT bother with relativity!
 - Spreadsheets, MATLAB, FEA...use whatever works best for you to yield and informative insightful answer in the least amount of time
 - Remember to use analysis to design experiments, and experiments to answer questions when analysis is too difficult
 - If you spend your time pushing on a rope, you will buckle from the strain!
- “Back-of-the-envelope” calculations are a critical part of the early conceptual design phase!
 - Kinematic constraints
 - Beam stresses
 - Power required
 - Tractive force
 - Tipping angle
 - ...
- Too many designers put-off analysis until its too late, and they are stuck trying to detail a design that fundamentally draws vacuum (S%\$KS!)

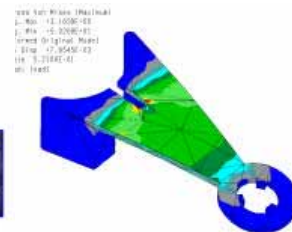
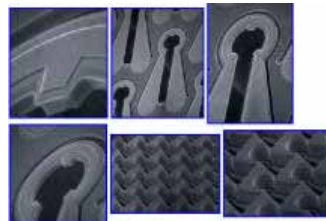

	A	B	C
1	With tapered beam design with constant thickness		
2	Enter numbers in BOLD		
3	Written by Alex Slocum, last updated 4/17/2006		
4	Force, F (lb, grams)	0.02	9.98
5	Thickness, t	2.50E-07	
6	Thickness, T	6.91E-04	0.01756
7	Length, L (in, mm)	0.025	0.635
8	Width at top, a (in, mm)	0.01	0.254
9	Width at base, b (in, mm)	0.03	0.762
10	radius slope, r0	0.8	
11	Dc mat	2.38913E-09	
12	Modulus	0.0005	
13	stress (psi)	209,281	
14	deflection (in)	0.00824	
15	straight beam defl	0.00505	

Analysis: *Geometry, Time, & Motion*

- The contest only lasts for N seconds, so do you have the time (and the power!) to do what is needed?
 - Maximum motor power is generated at ½ the motor's no-load speed!
- A simple spreadsheet can help answer these questions

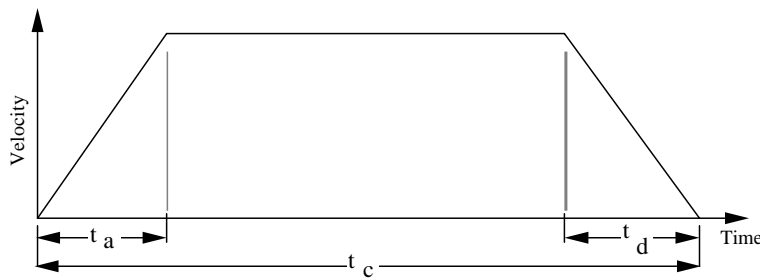

$$D = \frac{a_{\max}}{2} \left(\frac{t_d}{3}\right)^2 + \left(\frac{a_{\max} t_d}{3}\right) \left(\frac{2t_c}{3}\right) + \frac{a_{\max}}{2} \left(\frac{t_c}{3}\right)^2$$

$$a_{\max} = \frac{9D}{2t_c^2}, \text{ maximum acceleration (m/s}^2 \text{ or rad/s}^2\text{)}$$

$$v_{\max} = \frac{3D}{2t_c}, \text{ maximum velocity (m/s or rad/s)}$$

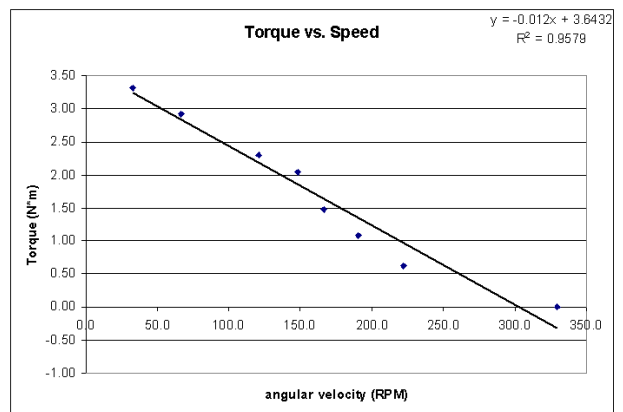

Analysis: *Energy, Momentum, & Strength*

- 1st check for the feasibility of a design: Is available Power > required power?
 - Example: Can I raise the pendulum through a 30 degree arc in 1 second using energy stored in constant force springs?
 - $mgh < FL_{\text{extension}}$
- 2nd check for the feasibility of a design: Is $\sigma_{\text{yeild}} >$ applied stress?
 - Example: Can I hold M kg extended out L m on a telescoping truss with H m cross section made from D mm welding rod?

$$\sigma = (MgL) \left(\frac{\pi D^2 H}{2} \right)$$

- It is a good idea to be aware of the physical capabilities of the kit materials, and the physical requirements of the scoring methods...

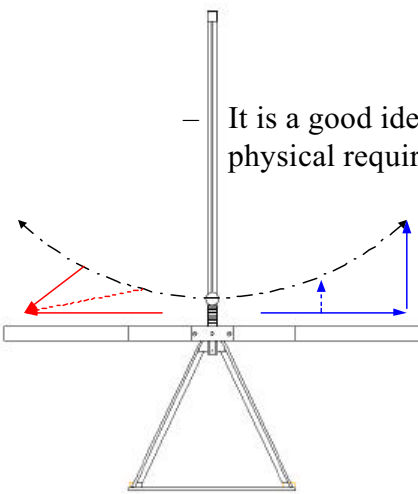

Evolving Systems

- Systems Approach
- Strategies-into-Concepts
- Teamwork
- Individual Thought
- Rohrbach's 635 Method
- Brainstorming
- Design Comparison Tab

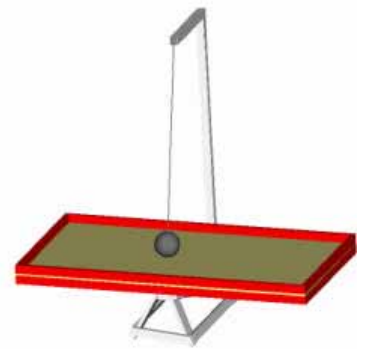
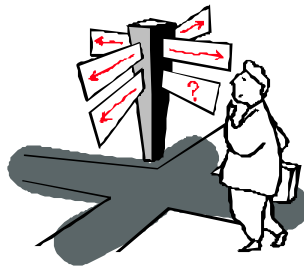

Colin Bulthap



1998's *Ballcano!*

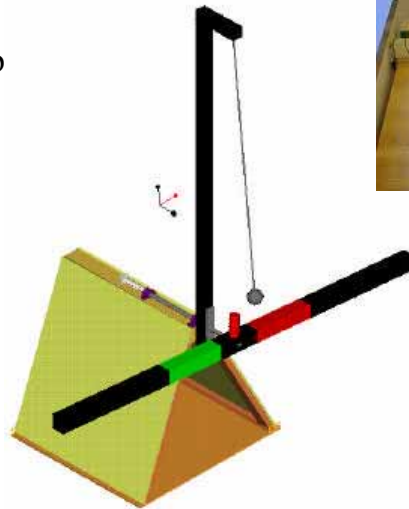

Evolving Systems: *Individual Thought*

- Individual thought is often the most creative
 - Do leisurely things (e.g., long walks) that you know inspire creative thought.
 - Look at what other people have created
 - Look in your home, stores, www, patents
 - Get out of traffic and take alternate routes
 - Sketch ideas and the ideas' principal components
 - Cut out the principal components and pretend they are modular elements
 - Like toy building blocks, try different combinations of components to make different products
 - Pit one idea against another and imagine strategies for winning
 - Take the best from different ideas and evolve them into the best 2 or 3 ideas
- Update the FRDPARRC table and create an “Milestone Report” or “Press Release” for your favorite ideas
 - The FRDPARCC Table (ONE DP per FR) and a large annotated sketch makes an effective infomercial
 - A random person should be able to read press release and fully understand your idea without your having to explain it to them
 - These sheets will be shared with your teammates in the next stage...



Evolving Systems: *Rohrbach's 635 Method*

- Six (N) people circulate their “Milestone Reports” (Press Releases) to the other five (N-1) for comments
 - A written record is thus also made of who first had the idea, so personality conflicts are more easily avoided
 - NO TALKING: people make written constructive comments on each other’s papers, until everyone has read everyone else’s press releases
- This creates a collective mind, so everybody knows what everyone else has been thinking
 - The group mind then works together in a more efficient manner when brainstorming...

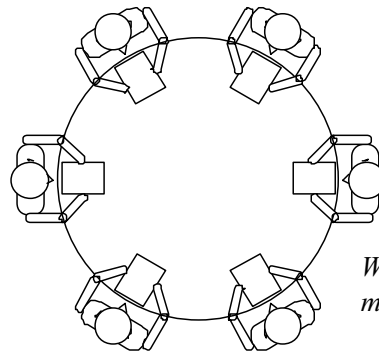
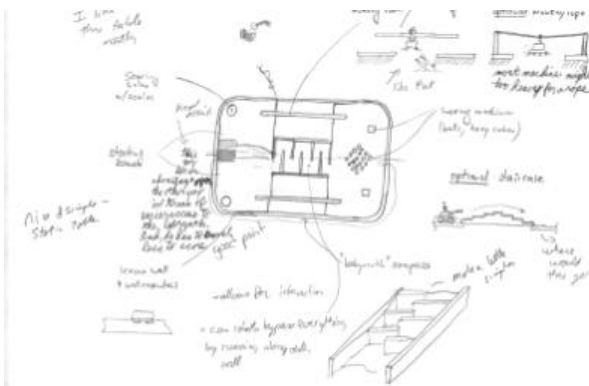

Why are these people missing an ear?!



Evolving Systems: *Group Brainstorming*



- Brainstorming helps teams solve personal creativity deadlocks and help to ensure something hasn't been overlooked
- Initially let everyone voice their suggestions, then distill ideas
- Group personality factors must be considered:
 - Shy individuals getting run over
 - Aggressive individuals always driving
- An individual's personality often has nothing to do with creativity
 - Careful to avoid conflicts over the issue of who first thought of the idea
 - The people in the group must be willing to take praise or scolding as a group
 - NO pure negatives, only observations with suggestions for improvement:
 - ~~“That design sucks!”~~
 - “I see a low pressure region that can be alleviated by making it blue” ✓

Evolving Systems: *Design Comparison Methods*

- There are many systematic methods available for evaluating design alternatives
 - The simplest method is a linear weighting scheme:
 - You may want to use the list of FRs as the evaluation parameters
 - Apply a relative importance weight to each evaluation parameter
 - Pick one design as a “baseline” (all zeros), and compare the rest (+ or -)
 - Easiest to use provided user bias can be minimized
 - When you find the “best” design, look at other designs that have higher weights and see how those characteristics can be transferred to the “best” design to make it even better!
 - A “Pugh” chart is similar, except that it does NOT use the weighting column!
 - A linear weighting scheme (a series of +, -, 0 wrt a baseline design) will give equal weighting to attributes



	A	B	C	D	E
1					
2					
3					
4					
5					
6					
7		Weight	Tilting Table	Peace Circle	Tilting Beam
8	Scoring variation	3	0	-1	0
9	Dynamic motions	2	0	0	1
10	Crowd appreciation	1	0	0	0
11	Manufacturability	1	0	1	0
12	Transportability	1	0	1	0
13	Scalability	2	0	0	0
14	Base for storage	1	0	1	0
15			0	0	2

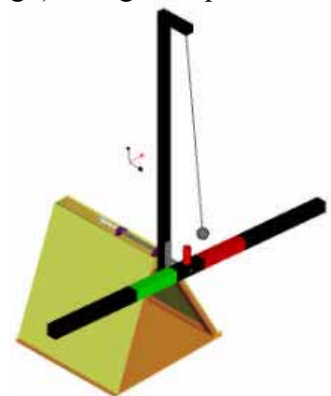

Conclusion: *Ideas are Created by Systematic Research, Playing, & Thinking*

- Physically experimenting with the hardware while thinking about all possible variations can produce many creative ideas
 - Sketching, drawing, and solid modeling are powerful creativity catalysts
 - Much has been done by others: Learn from the failures and successes
 - Writing down your thoughts and dreams can help you to see solutions
 - Analysis can identify areas of high (low) sensitivity and rapidly ascertain feasibility
 - Ideas can evolve rapidly when they are compared to others