

MIT OpenCourseWare  
<http://ocw.mit.edu>

HST.583 Functional Magnetic Resonance Imaging: Data Acquisition and Analysis  
Fall 2008

For information about citing these materials or our Terms of Use, visit: <http://ocw.mit.edu/terms>.



BIRN

# Quantitative Neuroimaging Biomarkers

Karl Helmer, Ph.D.

- Biomarkers
  - must have a scientific basis
  - a change in the marker must reflect a change in disease progression
  - be measurable and reproducible

Non-cognitive biomarkers are often used because cognitive measures often do not have a tight link to disease severity modifications.

# Overview



- The goal of biomedical imaging is to understand biophysical processes. Visualization can aid understanding.
- As medical knowledge progresses, the effects we study become ever more subtle.
- Statistically, we then need a larger number of independent measurements to get accurate and precise results for subtle effects. → acquire data at multiple sites...

# Overviews

- Which biomarkers are predictive?
  - do they track with disease progression and treatment effect?
- Can we measure these biomarkers in a multi-site trial, i.e., what is the size of the variability of:
  - site effects?
  - subject effects?
  - choice of processing algorithms and input parameters?

# Overview – Example I

- **Non-neuroimaging example:**

With imaging, we can visualize the effect of the drug, which can help decide drug efficacy. Later, it can monitor the effects of refinement in the drug formulation and dosing.

# Overview – Example I

## Treatment, 100mg/kg 5-FU

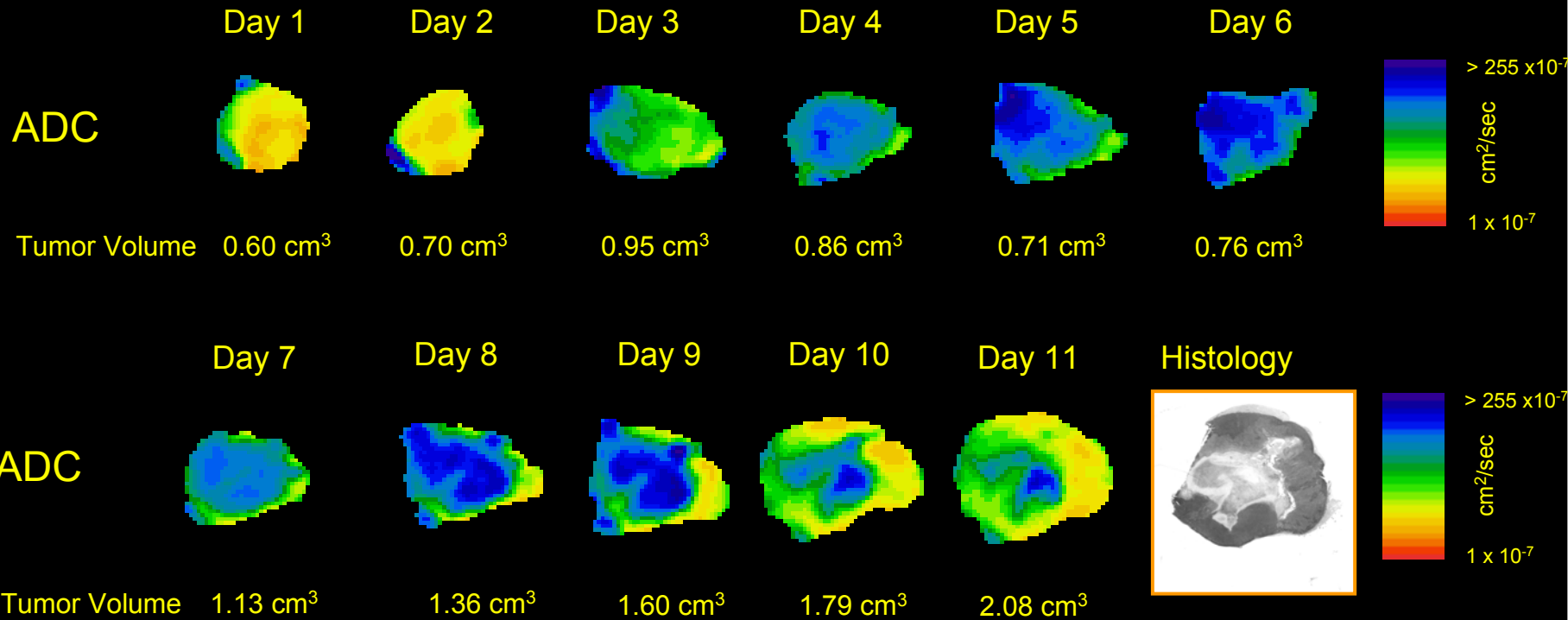

# Overview – Example II

## What if the disease effect on the biomarker is small?

“Several studies by Jack et al. (1998, 2000, 2004) of older **sporadic AD** cases (mean ages 74–79 years in the different studies) have reported annualized rates of hippocampal atrophy of 3–4% with age-matched **controls** (mean ages 77–80 years) having rates of atrophy of 1.4–1.7% per year and similarly aged **MCI** subjects have intermediate rates at 1.8–3.7% per year.”

- from “Differentiating AD from aging using semiautomated measurement of hippocampal atrophy rates.” Barnes J, Scahill RI, Boyes RG, Frost C, Lewis EB, Rossor CL, Rossor MN, Fox NC. Neuroimage. 2004:574-81.



# Alzheimer's Disease

- Clinical symptoms of AD are due to the loss of neurons and loss of viable connections between neurons.
- The medial temporal lobe (MTL) has the highest density of histopathological markers.

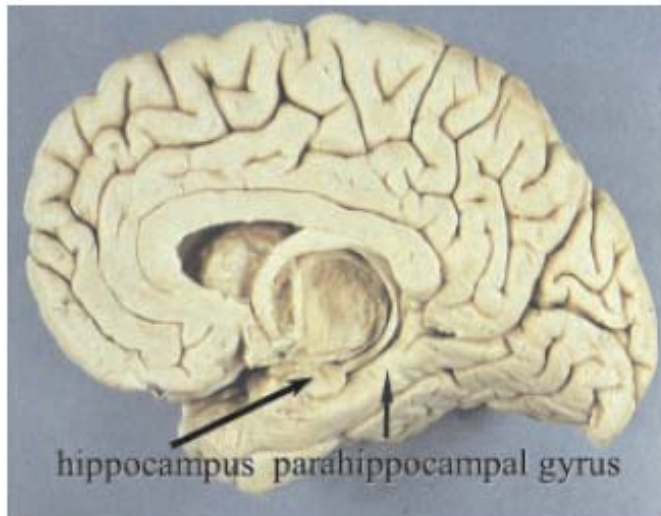

**Fig. 1.** Photograph of the median aspect of the human brain (front to left) showing two parts of the MTL, the hippocampus, and parahippocampal gyrus. The third part is the amygdala.

Deficits in verbal memory correlate with atrophy in left hippocampal volume and deficits in non-verbal memory correlate with atrophy in the right hippocampal volume.

From "Imaging the progression of Alzheimer pathology through the brain." David A. Smith, *Proc Natl Acad Sci U S A.* 99 (April 2,2002): 4135–4137.

Courtesy of National Academy of Sciences, U. S. A. Used with permission.

Copyright © 2002 National Academy of Sciences, U.S.A.

# Alzheimer's Disease

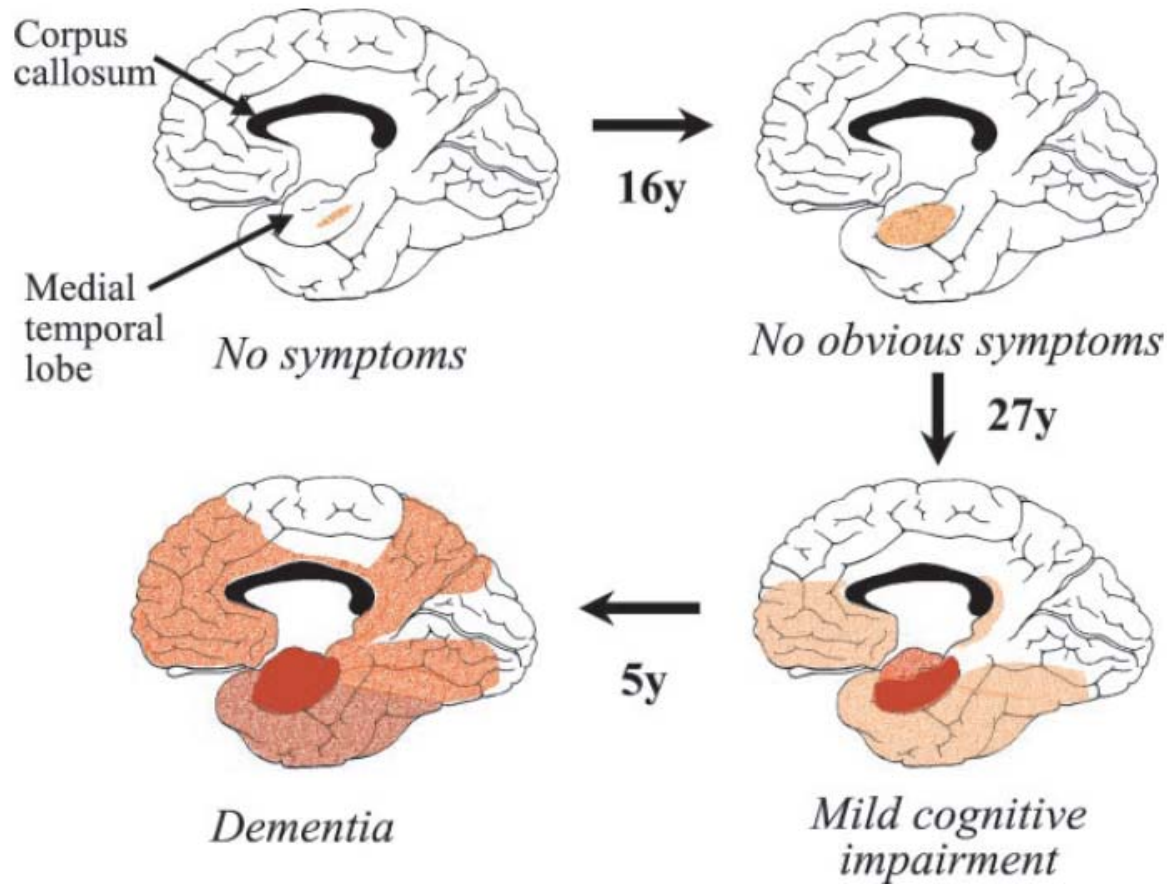

Fig. 3. Postulated sequence of spread of neurofibrillary pathology in AD, showing the medial aspect of the cerebral cortex. The depth of the red color is in proportion to the density of tangles (based on refs. 24 and 28). Several of the red areas showed atrophy in the study by Scahill et al. (6).

Courtesy of National Academy of Sciences, U. S. A. Used with permission.  
Copyright (c) 2002 National Academy of Sciences, U.S.A.

- Alzheimer's Disease Neuroimaging Initiative

A longitudinal multisite study of elderly people with either mild cognitive impairment (MCI, N=400), Alzheimer's Disease (AD, N=200) or normal cognition (N=200).

Data was collected at 55 sites.

Half of the subjects were imaged using FDG positron emission tomography (PET). All were imaged using MRI on a 1.5T scanner with a structural imaging protocol.

# ADNI

- Healthy controls sampled at: 0, 6, 12, 24, and 36 months
- MCI subjects sampled at: 0, 6, 12, 18, 24, and 36 months
- AD subjects sampled at: 0, 6, 12, and 24

In addition, urine, serum, and CSF biomarkers were acquired in addition to neuropsychiatric evaluations.

- ADNI Goals:

- 1) Identify best biomarkers for early diagnosis
- 2) Identify best biomarkers for following disease progression
- 3) Develop surrogate endpoints for clinical trials
- 4) Establish methods for dealing with multisite data

-from “The role of biomarkers in clinical trials for Alzheimer's Disease”. Thal LJ et al. *Alz Dis Assoc Disord* 20:6-15 (2006).

- ADNI Imaging Goals:
  - 1) Link all data at each time point and share data with public
  - 2) Develop technical standards for imaging in longitudinal studies
  - 3) Optimize acquisition and analysis
  - 4) Validate imaging and biomarker data with psychometric and clinical assessments
  - 5) Improve clinical trial methods

# ADNI – Technical Issues

- While humans can make sense of images with minor artifacts, this is not usually true of automated processing pipelines.

Therefore:

1. use larger fields-of view and many slices
2. no parallel imaging
3. no partial k-space imaging
4. correct for chemical shift artifacts
5. correct for intensity inhomogeneity

# Multi-site Trials

- Variance due to differences in sites!

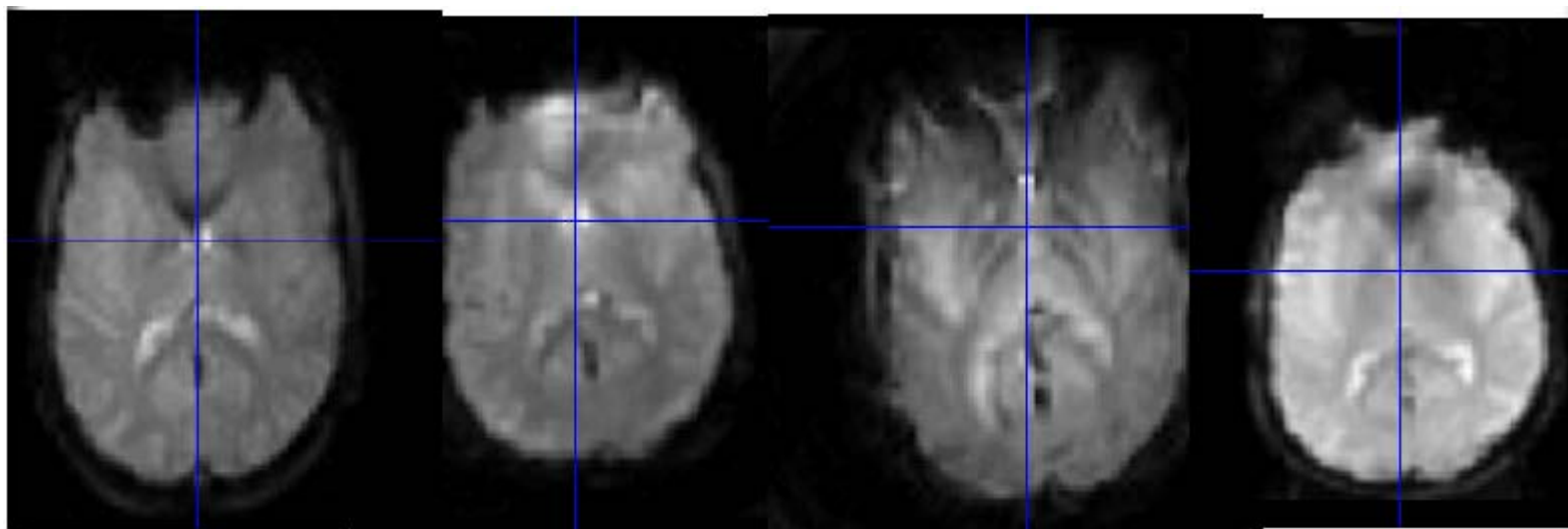

Same subject, same slice,  
different sites 'best' scan

Courtesy of Jessica Turner. Used with permission.



# ADNI – Technical Issues (Optimization)

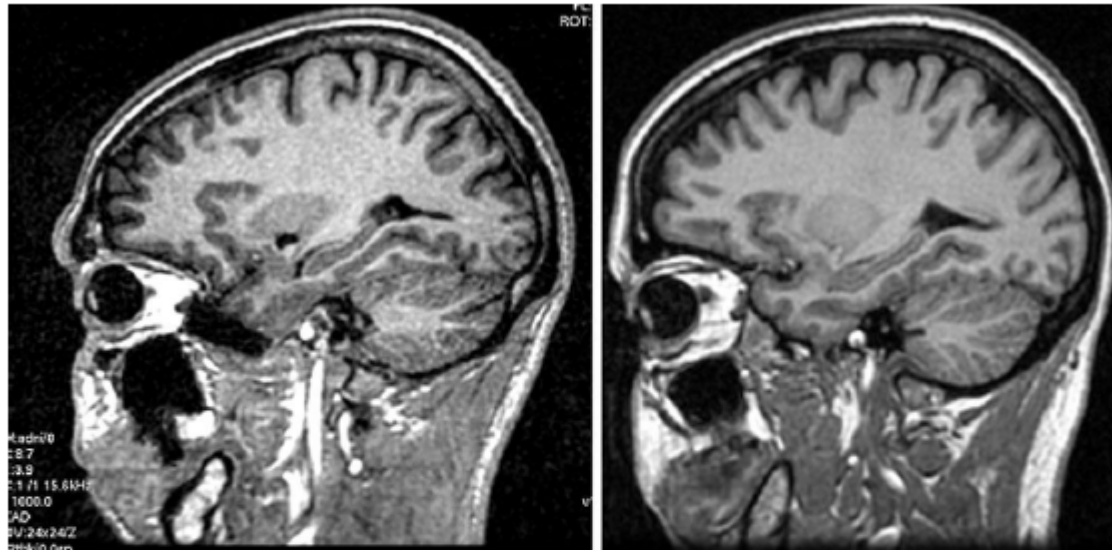
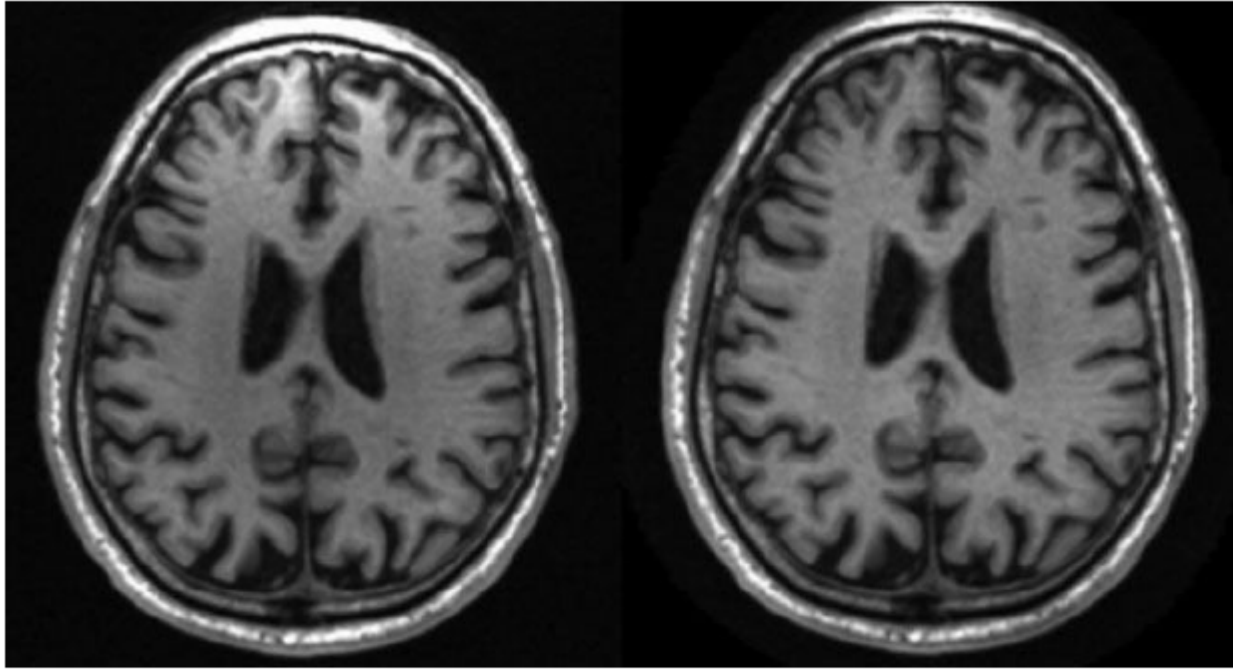

**Figure 2.**

Poor SNR with single-channel birdcage coils in first version of protocol. As indicated in Table 1, the protocol using a single-channel birdcage coil differs from the phased array protocol. Left: When 1.5 T images are acquired using the phased array protocol with a birdcage coil, poor SNR results. Right: Making the parameter adjustments listed in Table 1 resolves the problem without increasing chemical shift.

Copyright © 2008 Wiley-Liss, Inc., a subsidiary of John Wiley & Sons, Inc.  
Reprinted with permission of John Wiley & Sons., Inc.

# ADNI – Technical Issues (Artifacts)



**Figure 6.**

Intensity in-homogeneity correction. Phased array coil acquisition at 1.5 T before (left) and after (right) intensity nonuniformity correction. Images have been reformatted from the sagittal into the axial plane to illustrate the intensity in-homogeneity anteriority prior to correction.

Copyright © 2008 Wiley-Liss, Inc., a subsidiary of John Wiley & Sons, Inc.  
Reprinted with permission of John Wiley & Sons., Inc.

From "The Alzheimer's Disease Neuroimaging Initiative (ADNI): MRI Methods,  
Jack CR, JMRI 27:685-691 (2008).

# ADNI – Technical Issues (Artifacts)

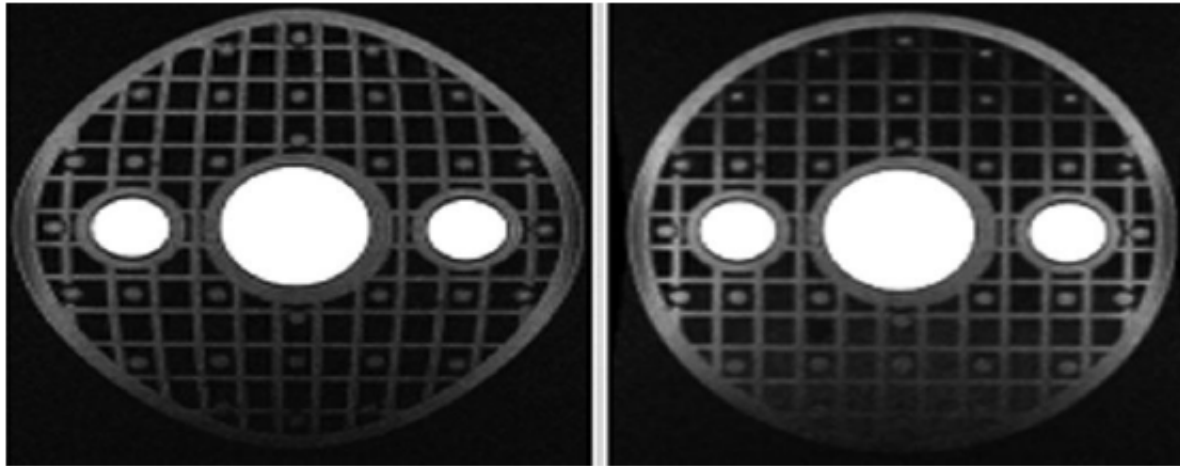

**Figure 5.**  
Effect of gradwarp. Spherical phantom with rectilinear grid inclusion before (left) and after (right) gradwarp correction.

Copyright © 2008 Wiley-Liss, Inc., a subsidiary of John Wiley & Sons, Inc.  
Reprinted with permission of John Wiley & Sons., Inc.

# Biomedical Informatics Research Network

**BIRN** Biomedical Informatics Research Network  
*fostering a new biomedical collaborative culture and infrastructure*

Search  
  
● BIRN ● WWW

Home Research Tools Data Contact Us Help BIRN Portal

**BIRN Collaborations**  
[BIRN Multi-site Collaborations](#)  
[Information on NIH Program Announcements](#)  
[News and Events](#)  
[Comments and Suggestions](#)

**BIRN Research**  
[BIRN Coordinating Center](#)  
[Morphometry BIRN](#)  
[Function BIRN](#)  
[Mouse BIRN](#)

**BIRN Tools**  
[Browse Our Tools](#)  
[Use Our Tools](#)  
[Share Your Tools](#)

**BIRN Data Repository**  
[View Data Currently Available](#)  
[Preview Data Coming Soon](#)  
[Data Use](#)  
[Share Your Data](#)

About Us Copyright Privacy Site Map Contact User Survey

BIRN is supported by NIH Grants to the BIRN Coordinating Center (U24-RR019701), Function BIRN (U24-RR021992), Morphometry BIRN (U24-RR021382), and Mouse BIRN (U24-RR021760).



[www.nbirn.net](http://www.nbirn.net)

Courtesy of BIRN. Used with permission.



# Multi-Center Imaging Study

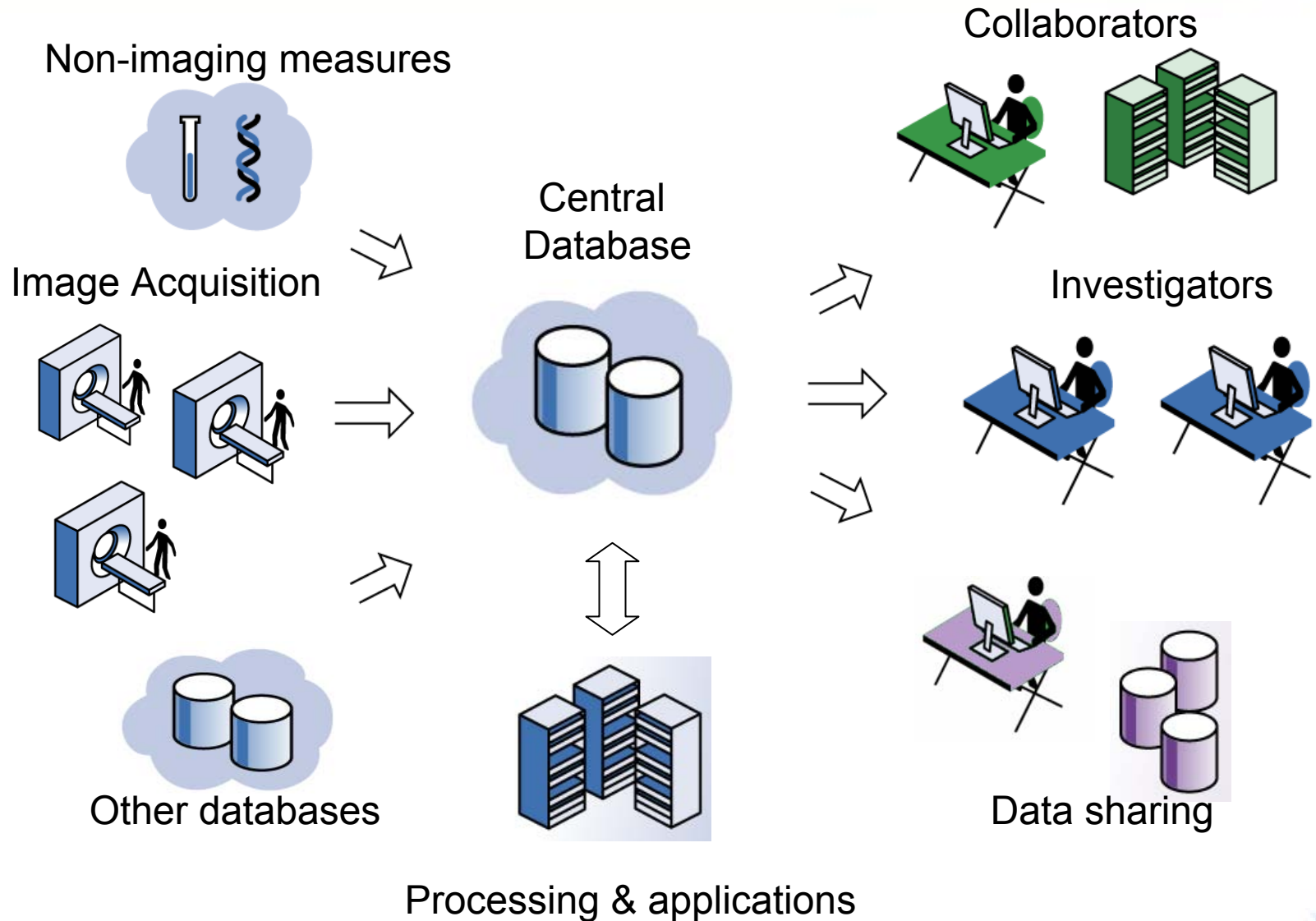

- Overall goal of the Morphometry BIRN:

To develop the ability to process and analyze, as a single data set, MRI data acquired across multiple sites, using tools developed at multiple sites. In addition, to allow data to be shared with the larger community.

# mBIRN Data Flow Diagram

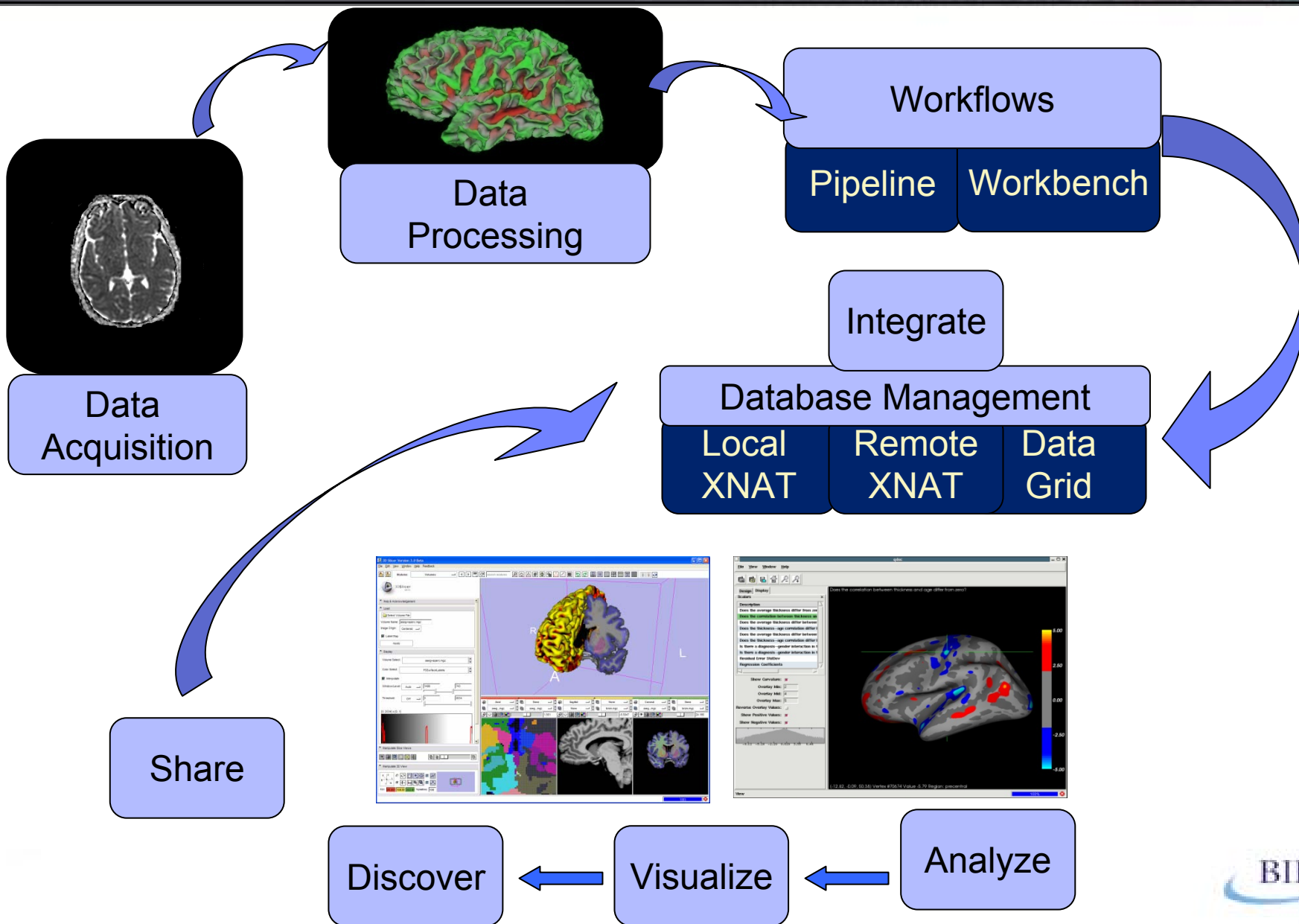

# mBIRN Use Case – Shape Analysis in AD

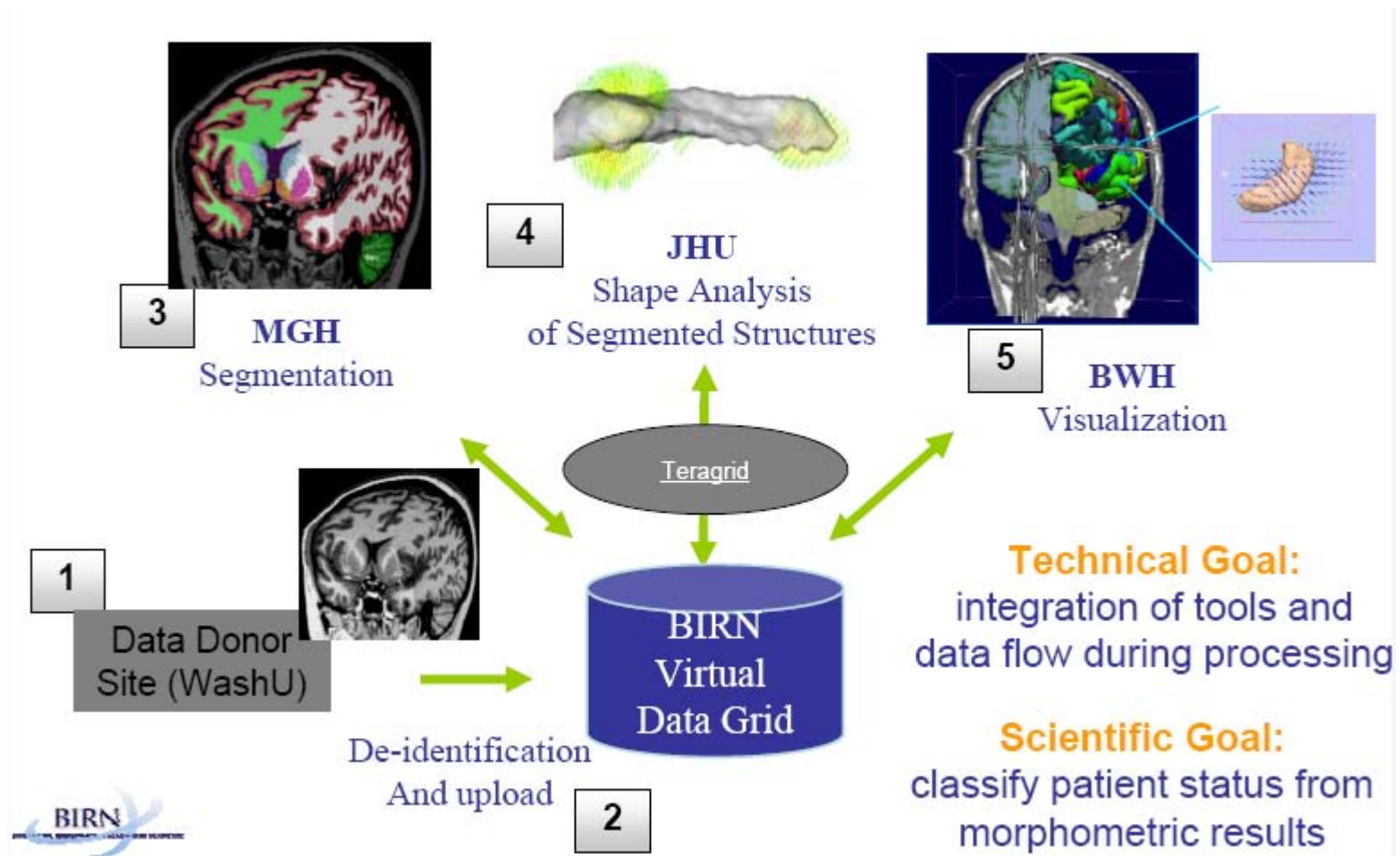

(45 subjects: 21 non-demented controls, 18 very mild Alzheimer's Disease and 6 semantic dementia).



# mBIRN Use Case – Shape Analysis

LD = Linear Discriminant

Image removed due to copyright restrictions.

(45 subjects: 21 non-demented controls,  
18 very mild Alzheimer's Disease and 6 semantic dementia).

# mBIRN Use Case – Shape Analysis

Image removed due to copyright restrictions.

# mBIRN Use Case – Shape Analysis

- **2006.05.02** (A. Kolasny)

The **101 subject** Iddmm processing has been completed. This required **244,824 cpu/hrs** of processing and **40TB** of storage.

SDSC and NCSA TeraGrid sites, BIRN SDSC cluster and JHU CIS cluster were used for processing the **40,804 Iddmm jobs**. We will now begin the statistical analysis and visualization processing.

- **2006.03.14** (A. Kolasny)

Added an additional 10TB of storage to the JHU CIS storage repository. This used to complete the right hippocampus processing. Experimenting with sshfs and unionfs to assist in cluster processing.

- **2006.02.10** (A. Kolasny)

Completed Iddmm processing for the 101 left hippocampus data sets. This computation required a total of **13 cpu/years** of computing. We utilized the JHU CIS cluster, SDSC BIRN Cluster and TeraGrid for the processing. The processing required 20TB of storage which is being stored on the BIRN rack and the TeraGrid /gpfs-wan storage repository. Started processing the right hippocampus data.

# mBIRN Use Case II – Cortical Thickness

- Changes in cortical thickness accompany normal aging, AD, Huntington's disease, amyotrophic lateral sclerosis, multiple sclerosis, ...

Can cortical thickness be used as a reliable biomarker?

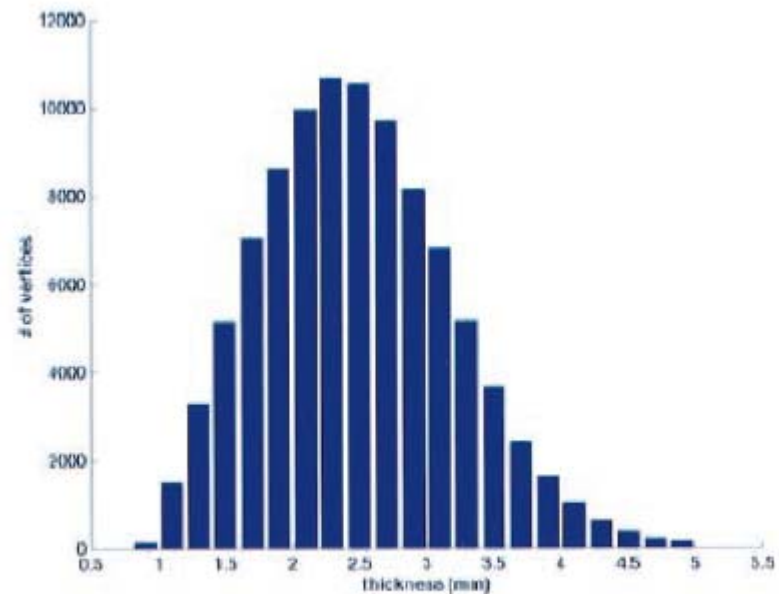

Fig. 3. Histogram of thickness values in cortical regions of the subject shown in Fig. 2. More than 99% of the surface is between 1- and 4.5-mm thick.

Courtesy of National Academy of Sciences, U. S. A. Used with permission.  
Copyright © 2000 National Academy of Sciences, U.S.A.

# mBIRN Use Case II – Cortical Thickness

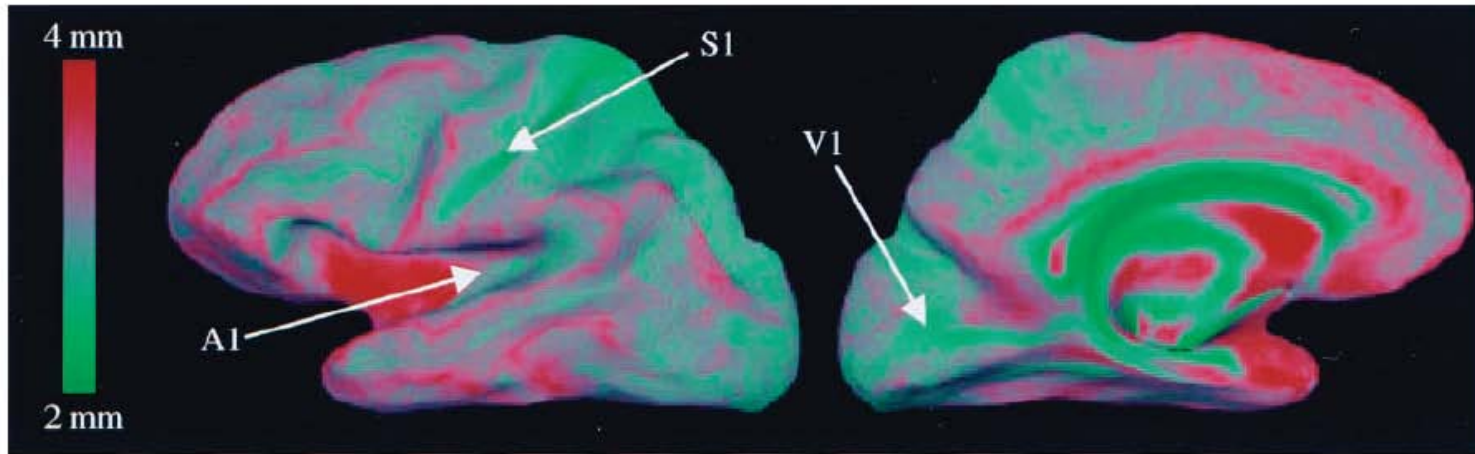

Fig. 4. Average cortical thickness across 30 subjects, with primary auditory (A1), somatosensory (S1), and visual (V1) cortices indicated by the white arrows.

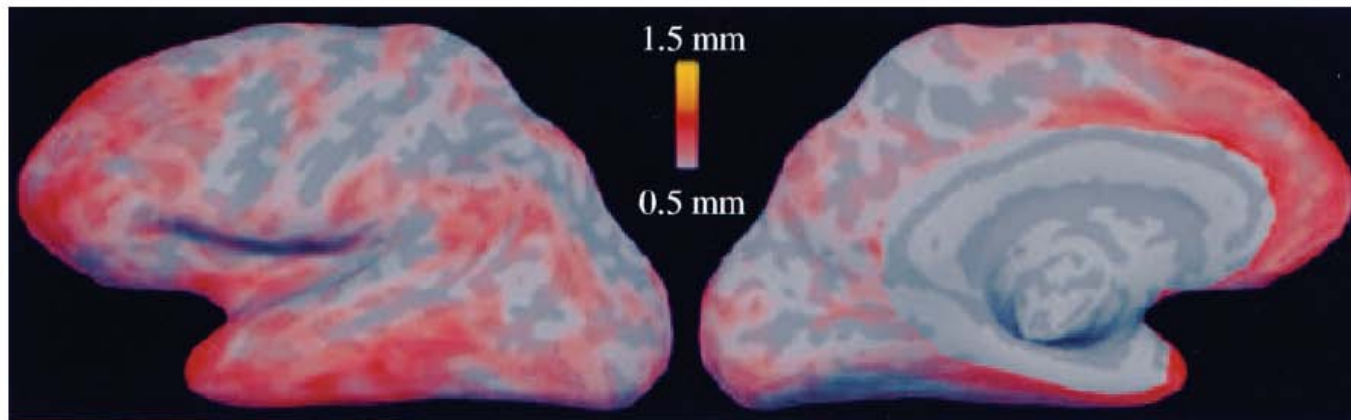

Fig. 5. Map of the standard deviations of the thickness measurements across 30 subjects. Noncortical regions have been excluded on the medial aspect of the surface.

Courtesy of National Academy of Sciences, U. S. A. Used with permission.  
Copyright © 2000 National Academy of Sciences, U.S.A.

# mBIRN Use Case II – Cortical Thickness

- BIRN cortical thickness reliability study
  - 15 healthy older subjects scanned a total of four times. The time between scans was two weeks and three different scanners were used:

Scan 1: Siemens Sonata 1.5T

Scan 2: Siemens Sonata 1.5T (rescan)

Scan 3: GE Signa 1.5T (cross platform)

Scan 4: Siemens Trio 3.0T (cross field strength)

(plus pulse sequence, multiple scans, smoothing)

# mBIRN Use Case II – Results

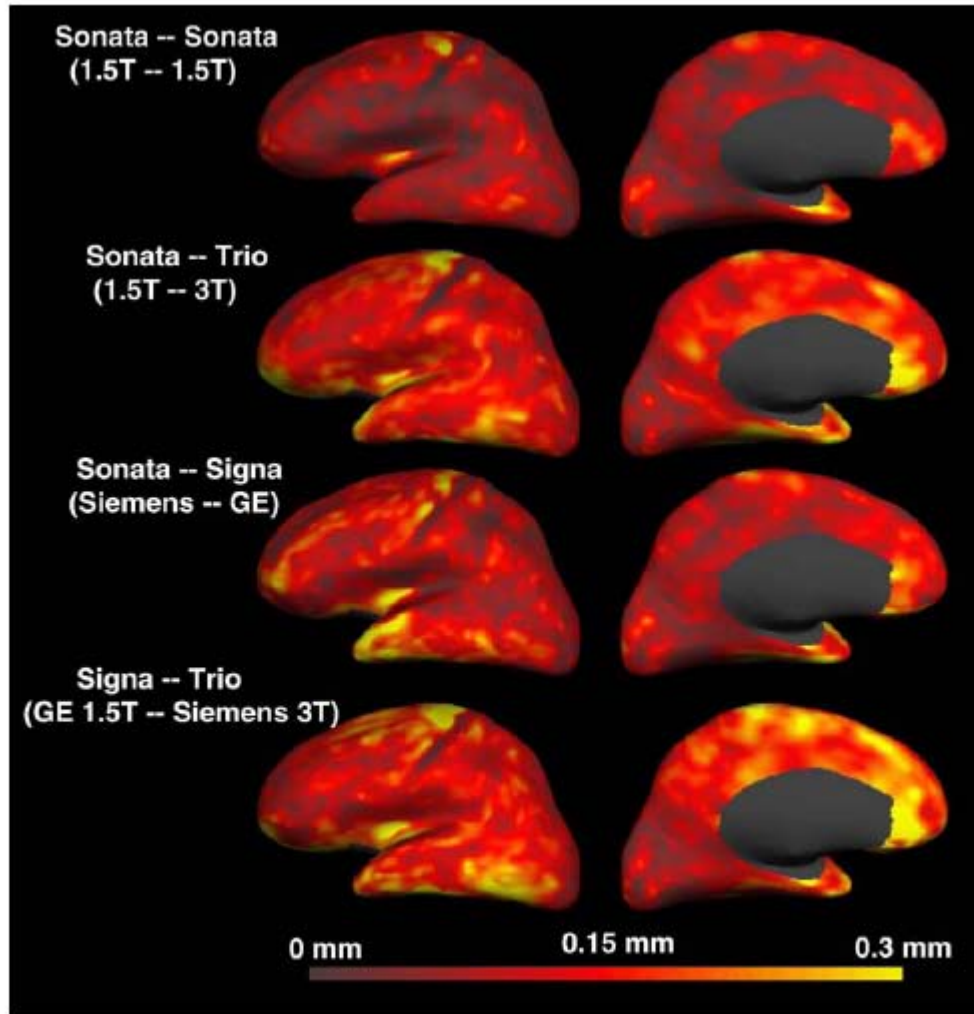

From Han, X. et al. "Reliability of MRI-derived measurements of human cerebral cortical thickness: the effects of field strength, scanner upgrade, and manufacturer." *NeuroImage* 32 (2006):180-194.

Courtesy Elsevier, Inc., <http://www.sciencedirect.com>. Used with permission.

Fig. 2. Maps of thickness measurement variability for four test-retest comparisons (the left hemisphere only; the right hemisphere is similar). Subcortical regions and corpus callosum area are masked out since thickness is not defined there. The measurement variability is less than 0.12 mm for most the cortex for the within-scanner test-retest comparison and less than 0.2 mm for across platform comparisons. Left column: lateral view; right column: medial view.

# mBIRN Use Case II – Results

- Within-scanner variability < 0.03 mm
- Cross-scanner variability = 0.15 mm
- Cross-field strength variability = 0.17 mm
- Measurements across field strength biased to the higher field strength (thicker)
- No effect from using the average of multiple runs, however using the 1<sup>st</sup> run as an initial guess for the processing resulted in a statistically significant reduction in variability.



# Function BIRN – Multi-site functional MRI

- The goal of the function BIRN is similar to that of mBIRN, but with a focus on functional MR imaging and schizophrenia used as the target population.

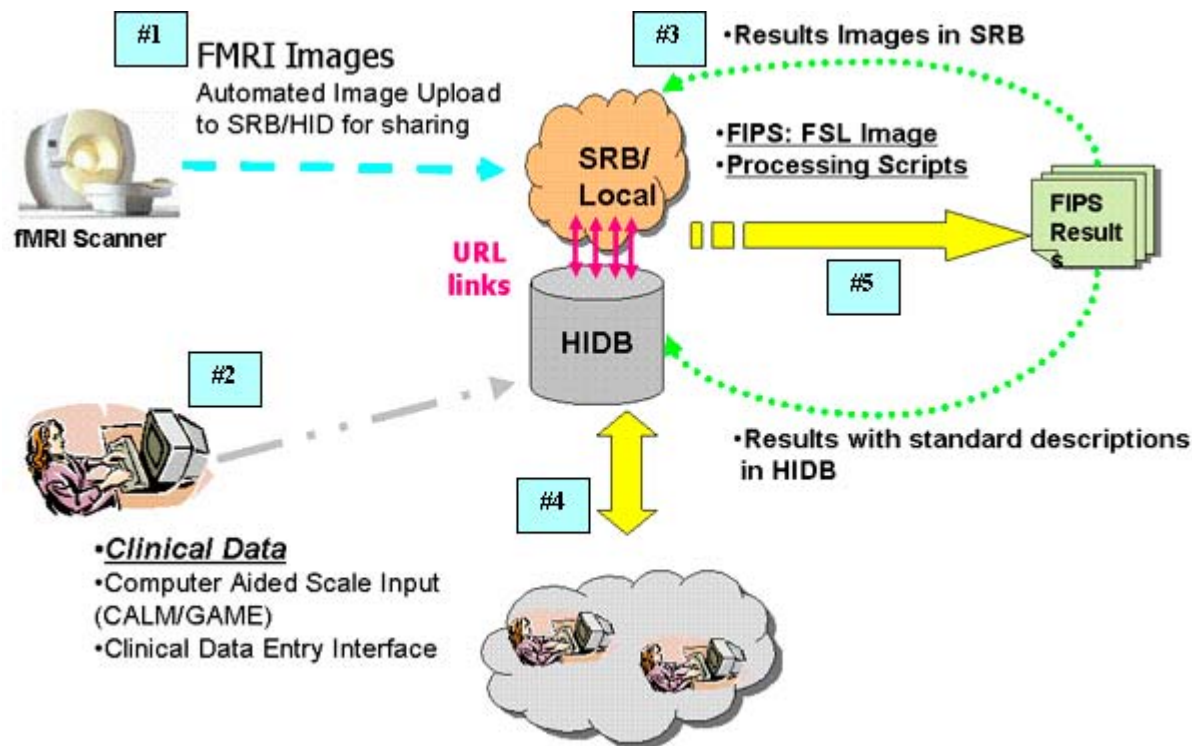

Courtesy of Jessica Turner. Used with permission.

# Functional MRI – Multisite Issues

- Differences in:
  - site hardware and software
  - data processing
  - subject's cortical structures
  - subject's activation magnitude on that day
  - brain networks elicited for each task

# Phase I – Travelling Human Phantoms

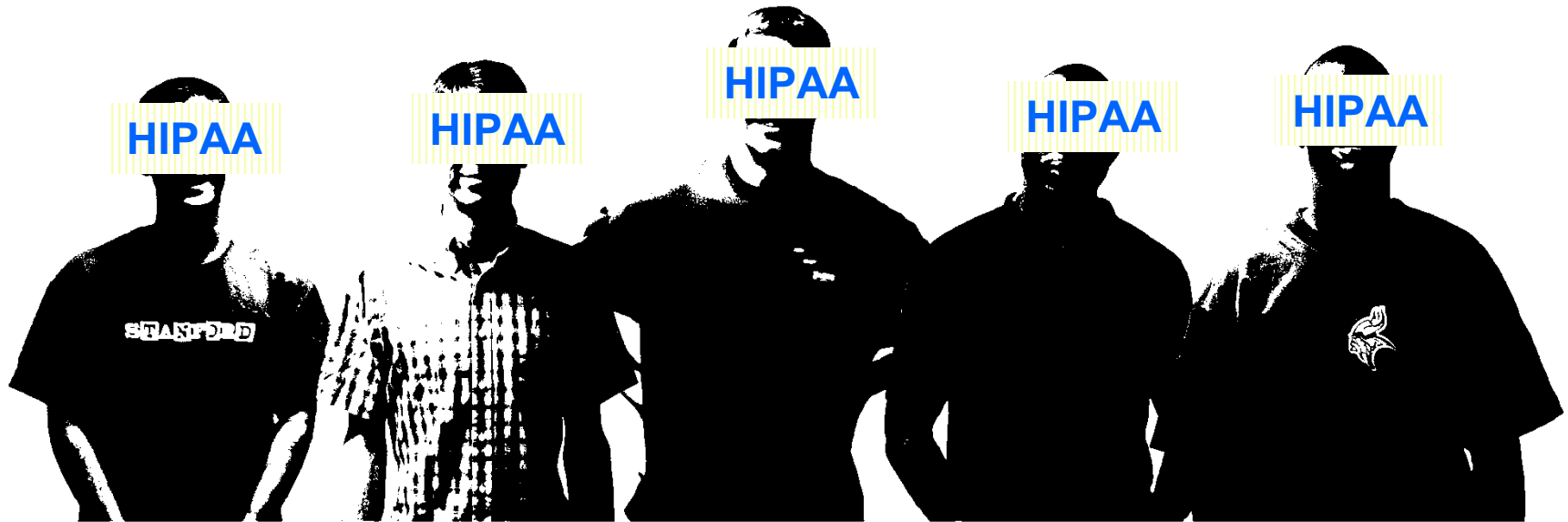

Courtesy of Jessica Turner. Used with permission.

Subjects traveled around the country to be scanned at all FBIRN sites

Unique dataset: Subject x site interactions can be measured for the first time

# Variance Components Analysis

ROI – Top 10% of Activated Voxels			
Variance Source	Auditory	Hand	Visual
Subject	18.8	18.3	21.8
Site	43.0	21.0	43.8
Day	0.0	0.0	0.1
Run	0.4	0.1	0.1
Subject X Site	3.6	14.6	10.5
Subject X Site+	20.7	35.2	20.0
Residual	1.5	4.2	1.5

VCA is a method to identify the individual contributions to the overall variance from the various possible sources.

Courtesy of Jessica Turner. Used with permission.

# fBIRN Calibration Methods

- To remove “spikes” that occur in image collection

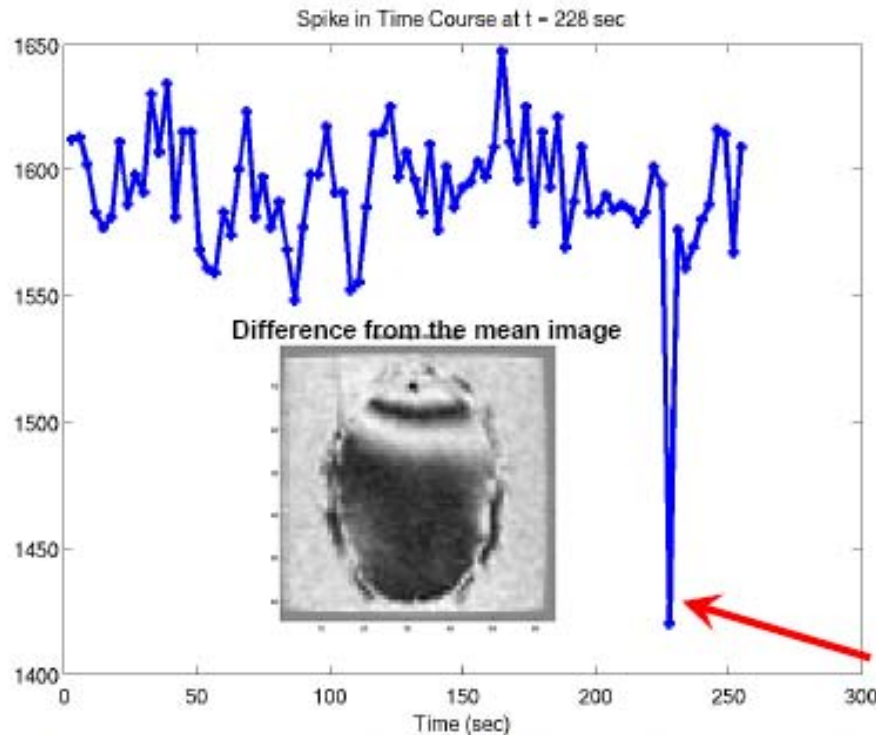

- In the traveling subjects dataset, these occurred in .01% of the images
- Looking for them visually is not feasible

- Automated spike detection and removal allows millions of images to be processed correctly

Courtesy of Jessica Turner. Used with permission.

# fBIRN Calibration Methods

- Scaling by the breathhold response increases group effect size



**Differences between young and old subjects in an fMRI task, before and after correcting for BOLD differences in a separate breathhold task**

Courtesy of Jessica Turner. Used with permission.

# fBIRN Calibration Methods

## Smoothing to a common level reduces inter-site effects

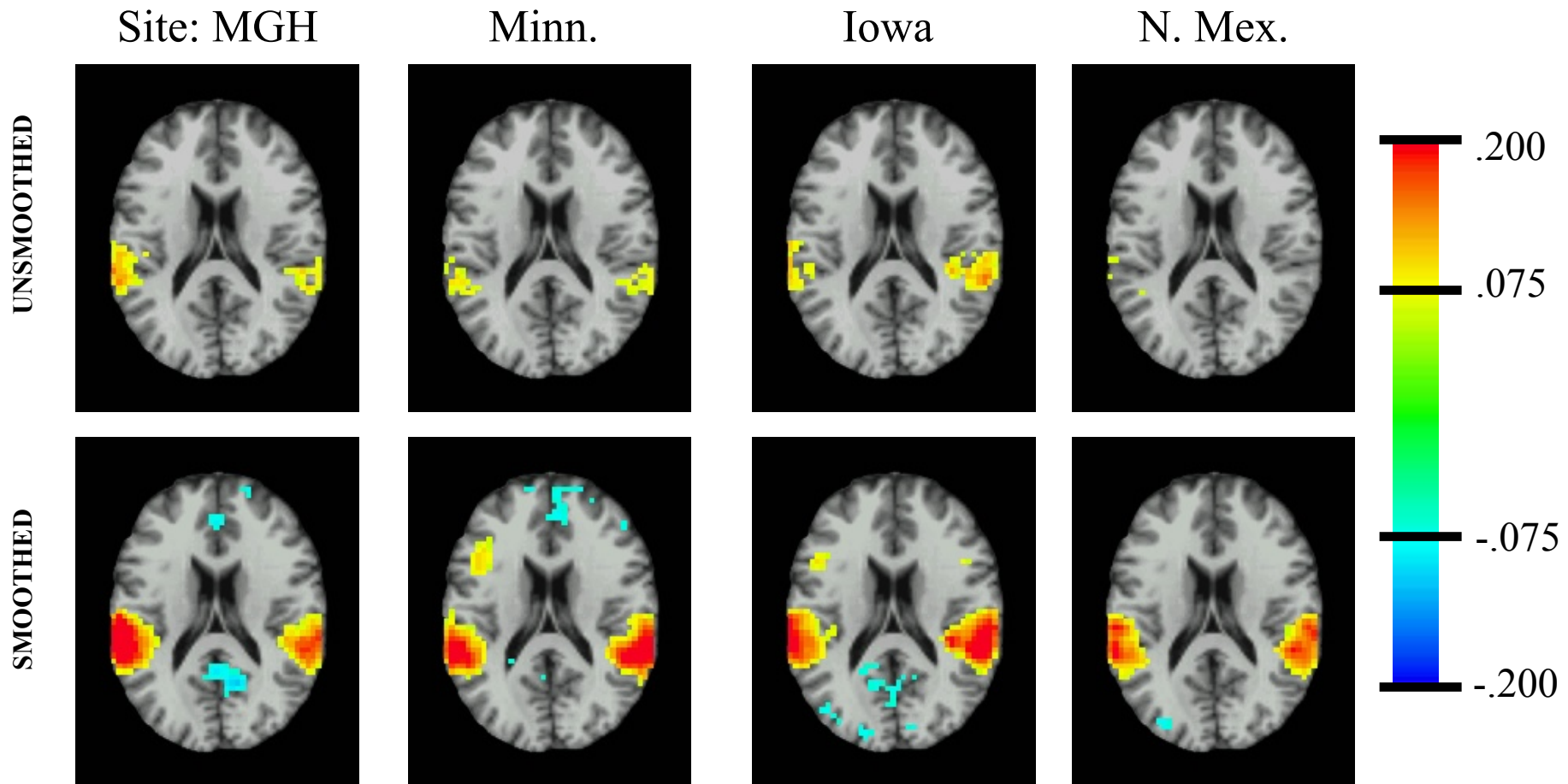

Courtesy of Jessica Turner. Used with permission.

# Impact of fBIRN Calibration Methods

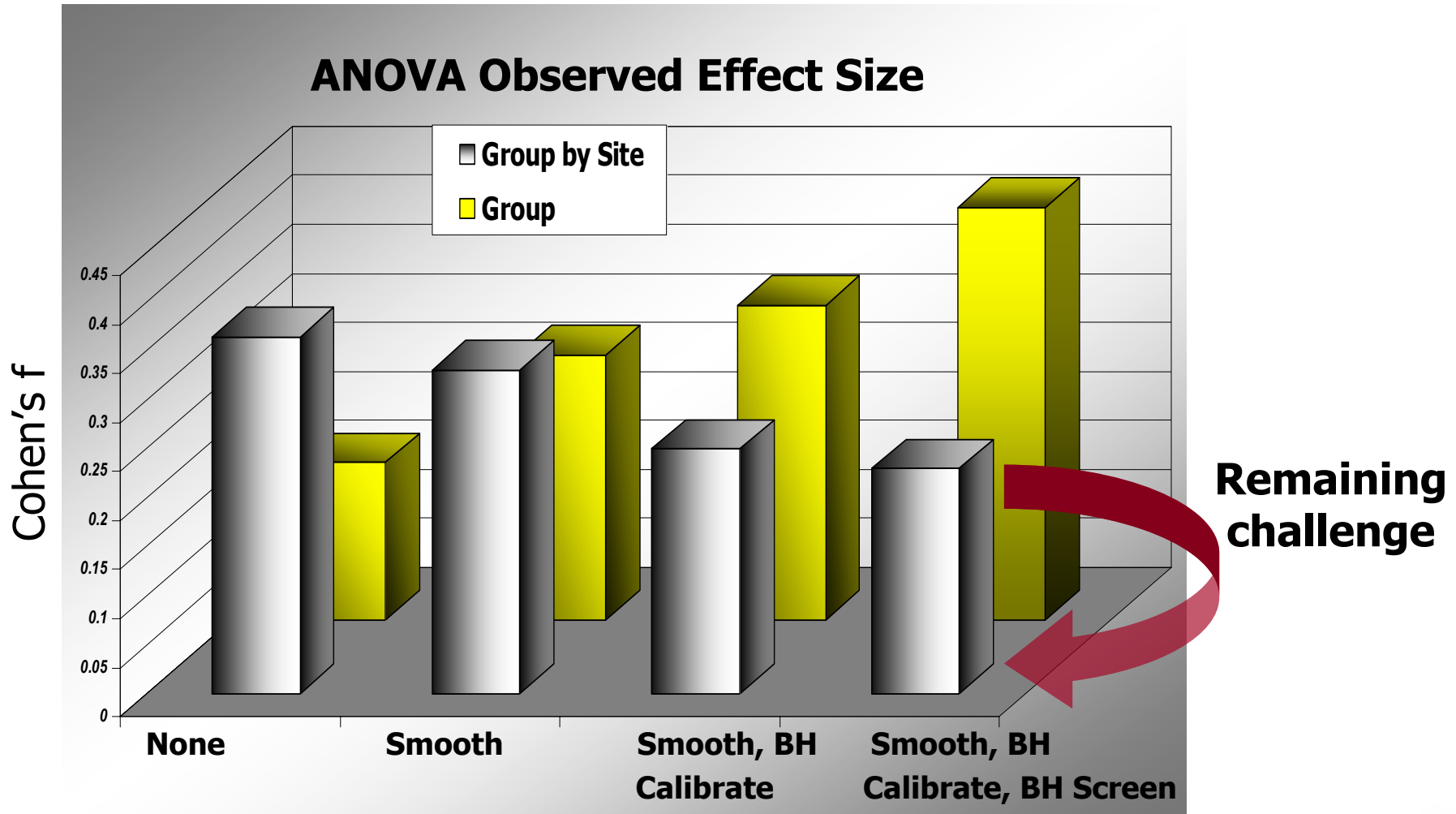

Courtesy of Jessica Turner. Used with permission.



# Biomarkers - Conclusion

- The establishment of reliable biomarkers necessitates understanding and overcoming sources of variability due to subject and site.
- Access to a common set of acquisition protocols, processing and analysis tools, and data sharing infrastructure increase the chances of success.

## Portal

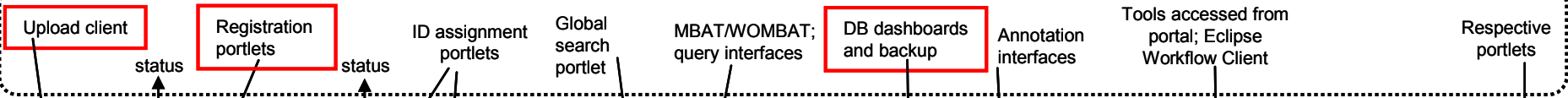

## Upload

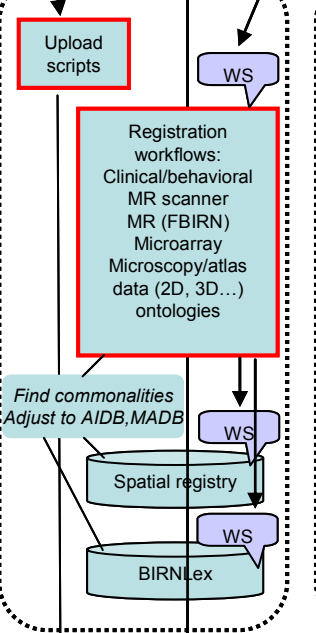

## Organize

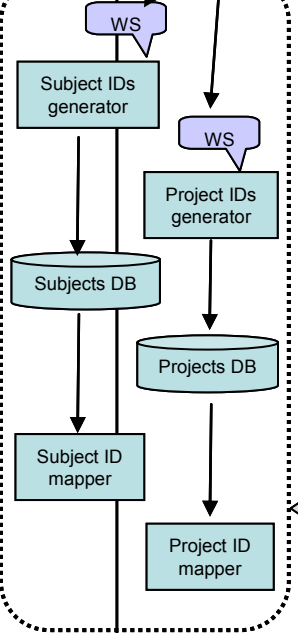

## Discover

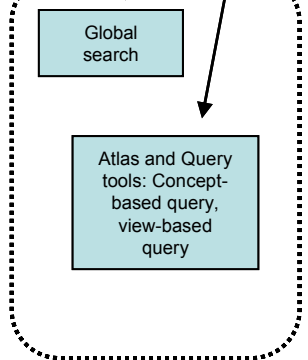

## Access

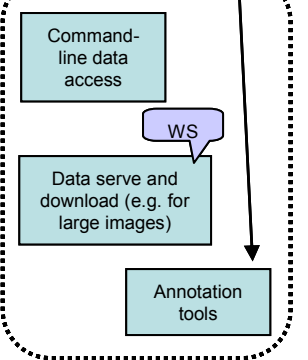

## Analyze

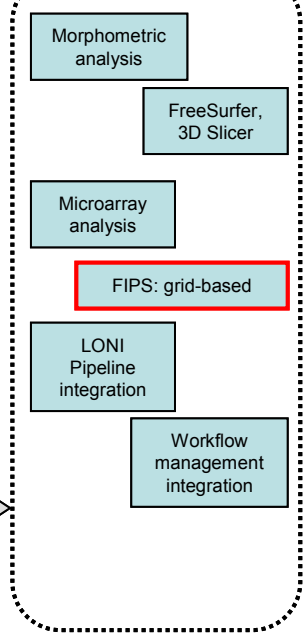

## Collaborate

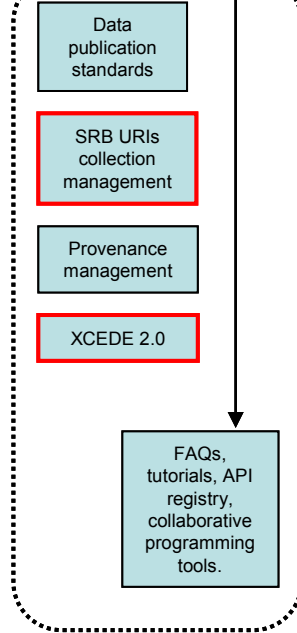

## Integrate

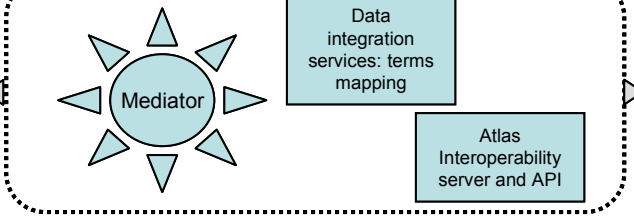

## Databases

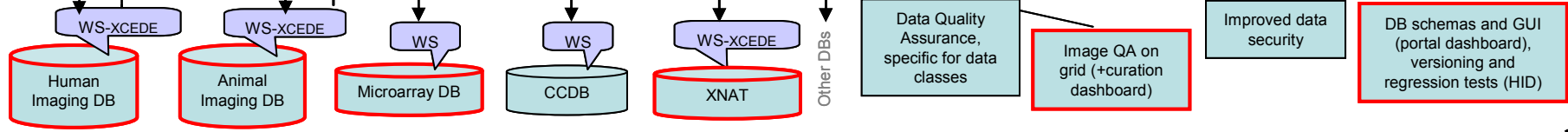

## Grid infrastructure

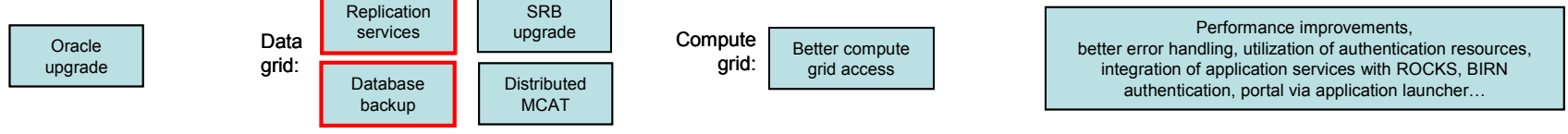

WS : web service interface      [Red Box] : high priority