



Rope Behavior

Dave Custer

ÒS.255

Spring 2006

Overview

- Simple models
 - Very simple
 - Wexler
- More complications
 - Damping
 - Carabiner friction
 - Belayer behavior
- What you can do with the simple models
 - Estimate forces and times
 - Figure out how often to place gear
 - Evaluate ropes
 - Test testing laboratories
- Experimental results
 - Mägdefrau data
 - Belay and sharp edge tests
 - Humidity

where the energy goes

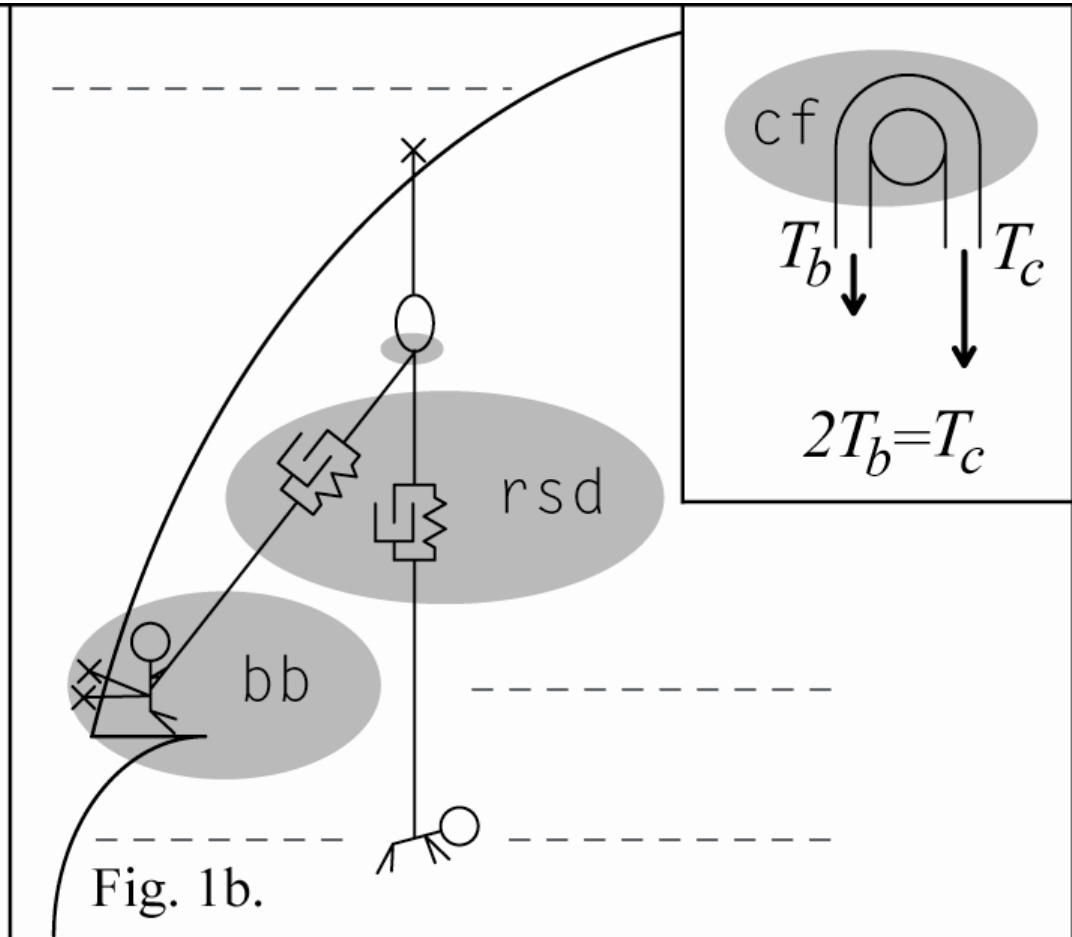
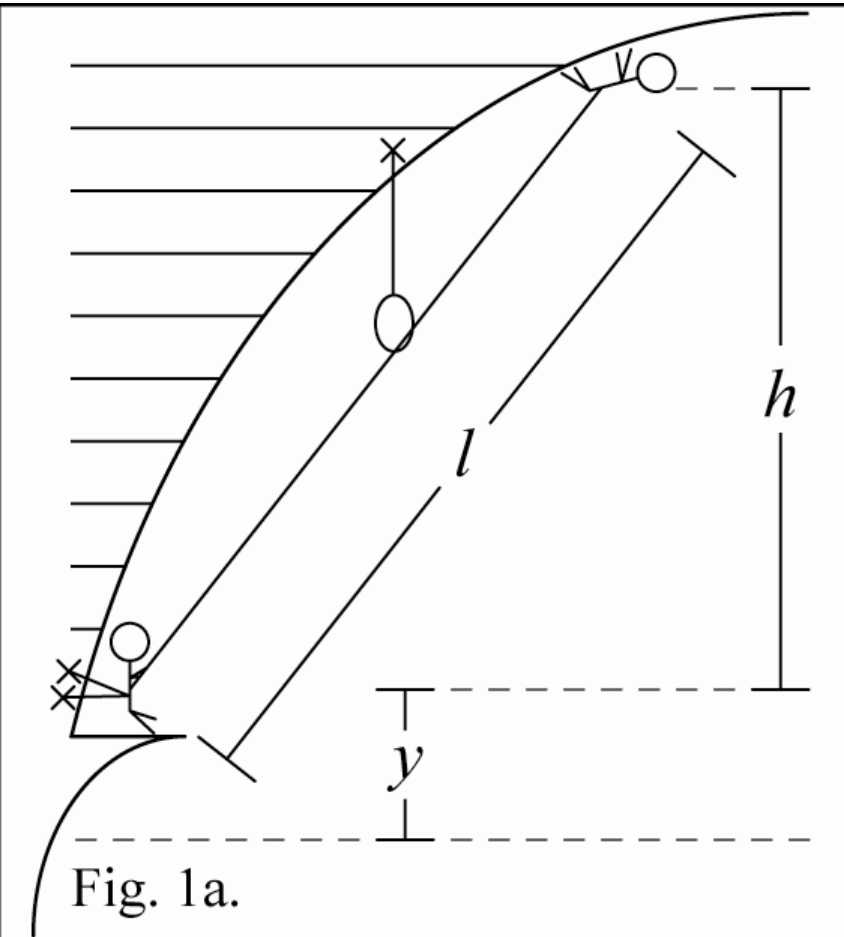

The Simple Model

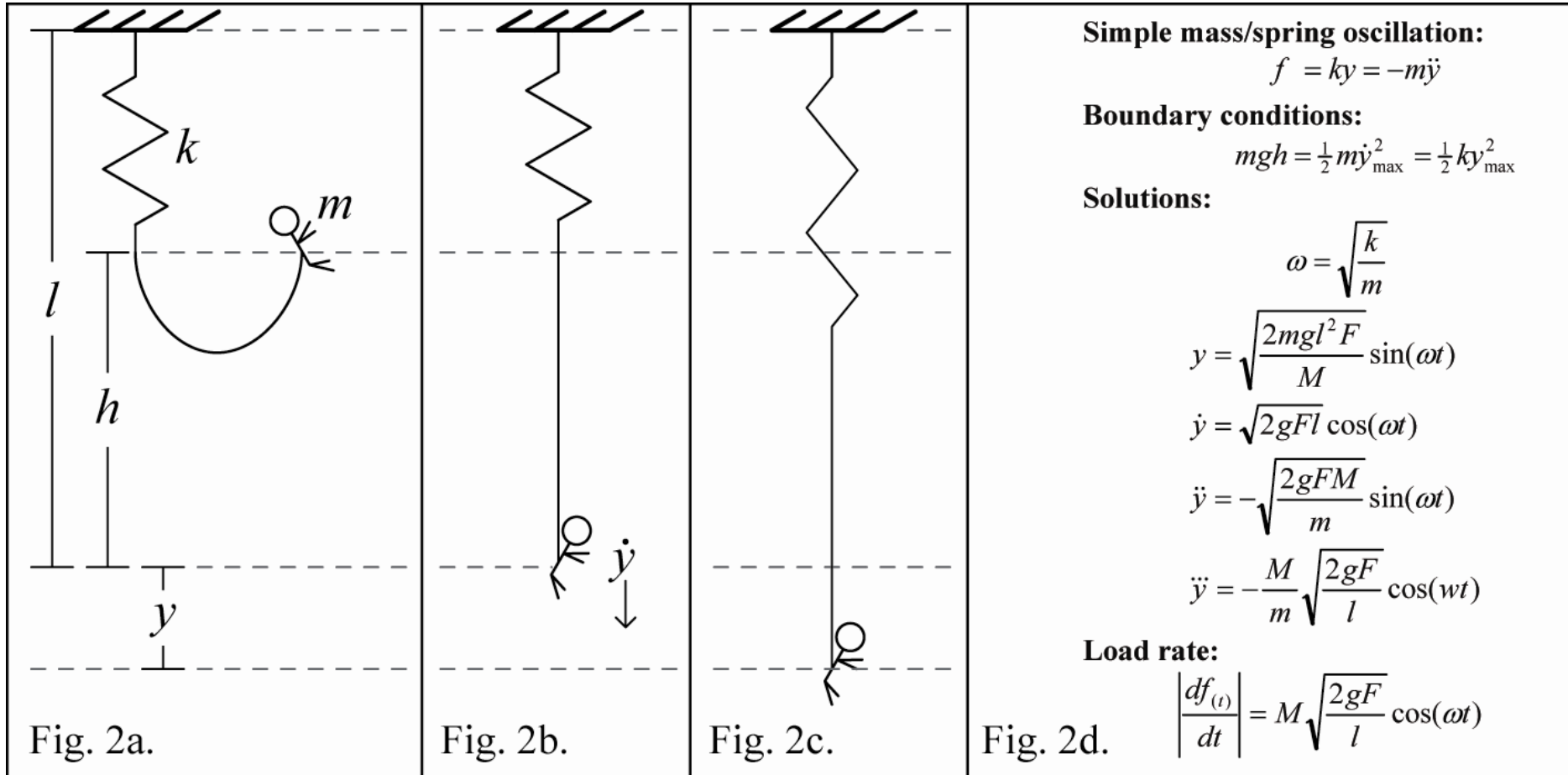

Based on Wexler, 1950

The Wexler Equation

Conservation of energy dictates that the climber's gravitational potential energy before the fall is equal to the spring energy stored in the rope after the fall:

$$mgh + mgy = \frac{1}{2}ky^2$$

Solve for y and ignore the imaginary root:

$$y = \frac{mg + \sqrt{m^2g^2 + 4\frac{1}{2}kmgh}}{2\frac{1}{2}k} = \frac{mg + \sqrt{m^2g^2 + 2kmgh}}{k}$$

The maximum tension in the rope (the Wexler equation):

$$T_{\max} = mg \left(1 + \sqrt{1 + 2 \frac{M}{m_c g} \frac{h}{L}} \right) = mg \left(1 + \sqrt{1 + 2 \frac{M}{m_c g} ff} \right)$$

Contributions to terms in the Wexler equation

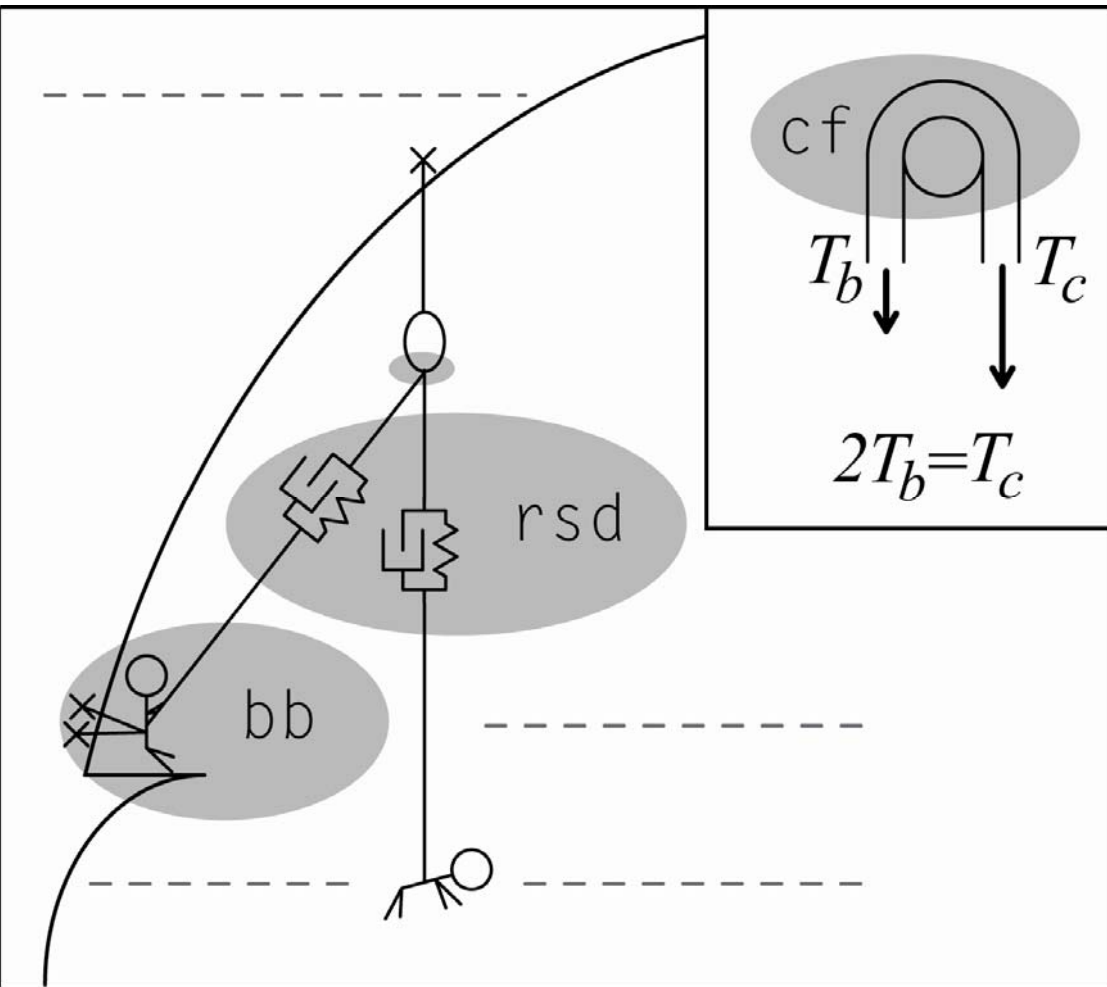

$$mgh + mgy = \frac{1}{2}ky^2$$

$$T = mg \left(1 + \sqrt{1 + 2 \frac{MF}{mg}} \right)$$

Friction over the top carabiner increases the rope modulus.

Belayer behavior and damping reduce the quantity under the radical sign.

Kinematics Graphs (simple spring)

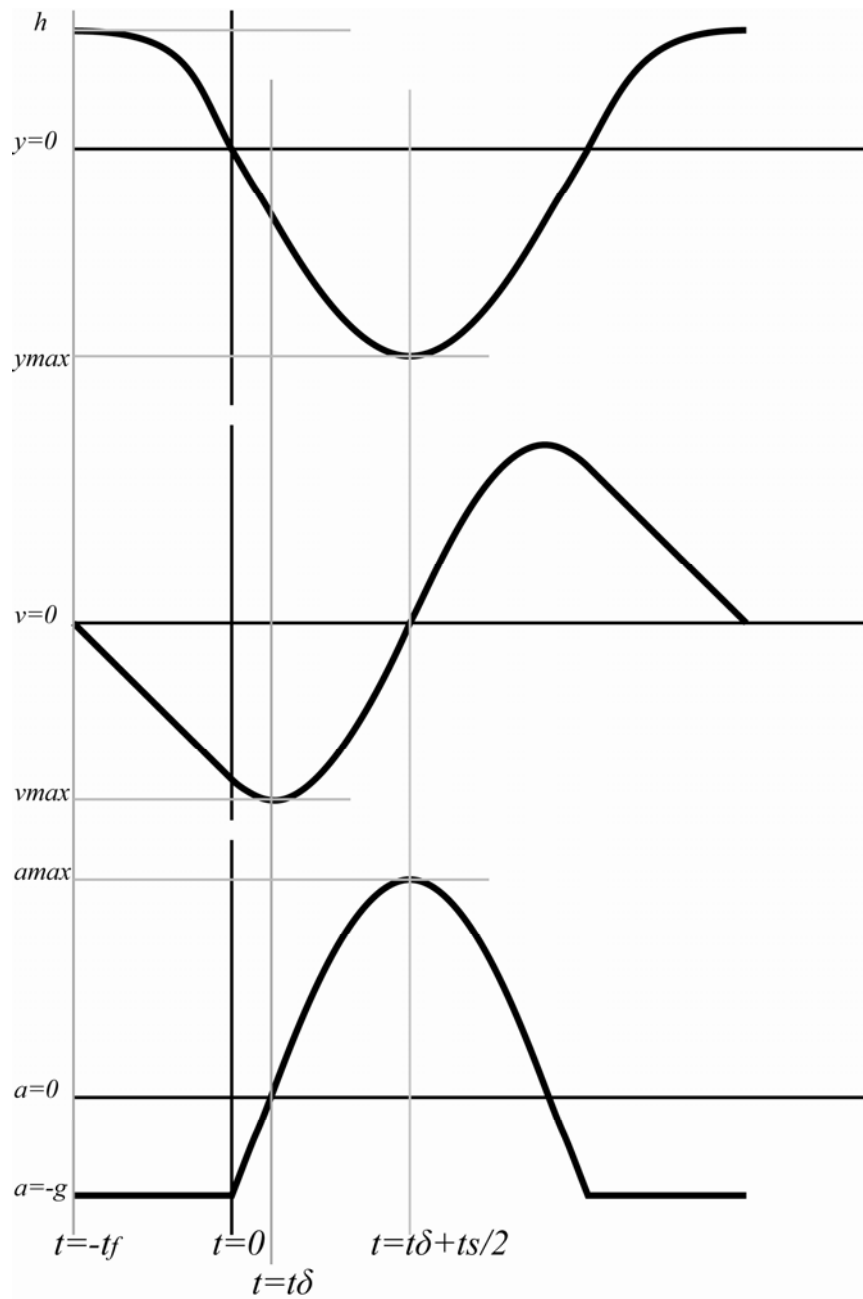

Friction Over the Top Carabiner

Big Picture

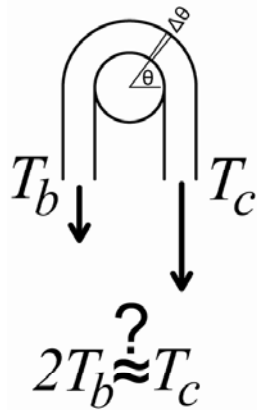

Free Body Diagram

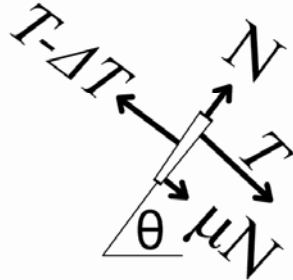

Σ Forces in the Radial and Tangential Directions

$$T - \Delta T = T + \mu N$$

$$N = T \sin \Delta \theta$$

Trig Substitution, Integration, Plug In Boundary Conditions, Write Answer

$$-\Delta T \leq \mu T \sin \Delta \theta$$

$$-\Delta T \leq \mu T \Delta \theta$$

$$\frac{\Delta T}{T} \geq -\mu \Delta \theta$$

$$\int \frac{\Delta T}{T} \geq \int -\mu \Delta \theta$$

$$\ln T \geq -\mu \theta + c$$

$$T_b \geq T_c e^{-\mu \theta}$$

$$\mu \approx 0.3, \theta = \pi, e^{-\mu \theta} \approx 2.6$$

The dependency of the friction coefficient on mass, velocity, diameter, rope coating, and temperature has not been investigated

Pavier Model & Damping

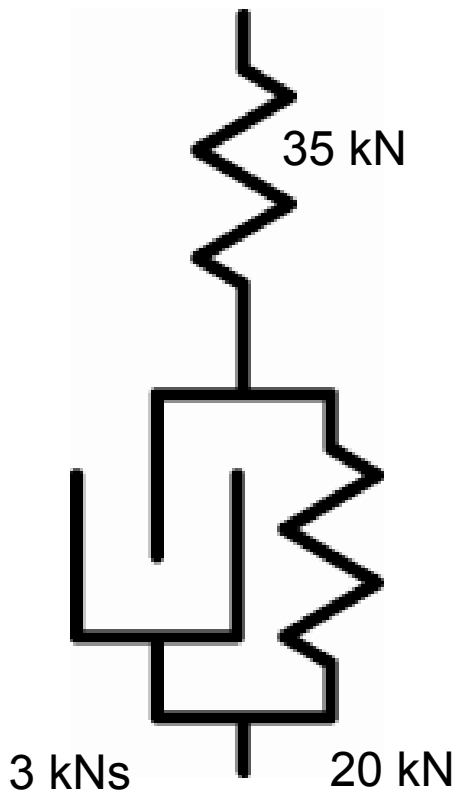

Spring in series with spring/dashpot parallel combo

Provides general idea of damping coefficient

Produces close match between model and experiment

Matches with the observation that climbing ropes are not far from critical damping/more than half the energy is lost in each cycle

No model for why this works

Silly Math Tricks with Rope

Hangtag Info

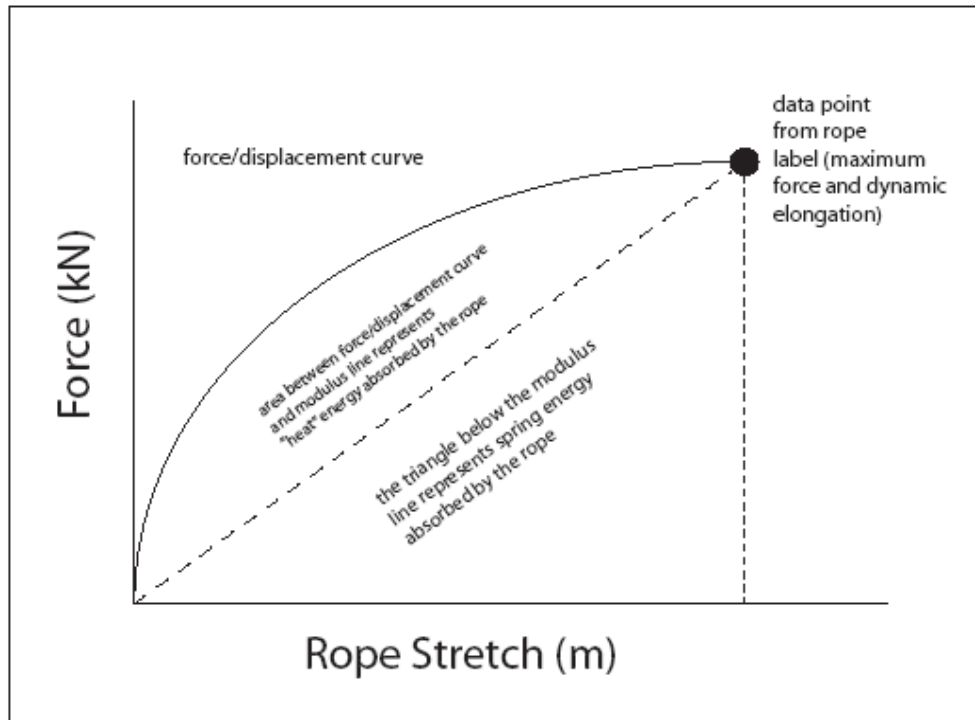

The hang tag provides the force and % rope extension. The length of rope and the fall height are defined by the test standard.

The ratio of heat to spring energy: $\gamma_{sh} = \frac{U_s}{U_h} = \frac{\frac{1}{2} F_{uiaa} (2.8 \text{ m} \times \epsilon_{uiaa})}{80 \text{ kg} \times 9.8 \text{ m/s}^2 \times (4.6 \text{ m} + (2.8 \text{ m} \times \epsilon_{uiaa})) - \frac{1}{2} F_{uiaa} (2.8 \text{ m} \times \epsilon_{uiaa})}$

GROMF Conditions

Table #: Generic, run of the mill fall (GROMF) characteristics			
<i>quantity</i>	<i>symbol</i>	<i>value</i>	<i>Units</i>
Mass of climber	m_c	80	Kg
Acceleration of gravity	g	10*	m/s ²
Rope modulus	M	24000	N
Rope length	L	30	M
Free fall height	H	2	M
Fall factor	ff	1/15	
Spring constant of rope	$k=M/l$	800	N/m

GROMF Estimates

Approximate GROMF results based on modeling the rope as a simple spring			
<i>quantity</i>	<i>symbol</i>	<i>value</i>	<i>units</i>
Time of free fall	t_f	0.6	s
Time from rope engagement to dead-point	t_δ	0.1	s
Time of rope stretch (total)	t_r	1.2	s
Time, top to bottom of fall	$(t_f + t_r/2)$	1.2	s
Rope stretch	y_{max}	3.2	m
Total fall height (free fall height + rope stretch)	$h + y_{max}$	5.2	m
Velocity at the end of free fall	v_0	6.3	m/s
Velocity at dead-point	v_{max}	7.1	m/s
Maximum deceleration	a_{max}	30	m/s ²
Frequency (angular)	ω	3.2	s ⁻¹

Attaway Admonition(s)

Gear Placement

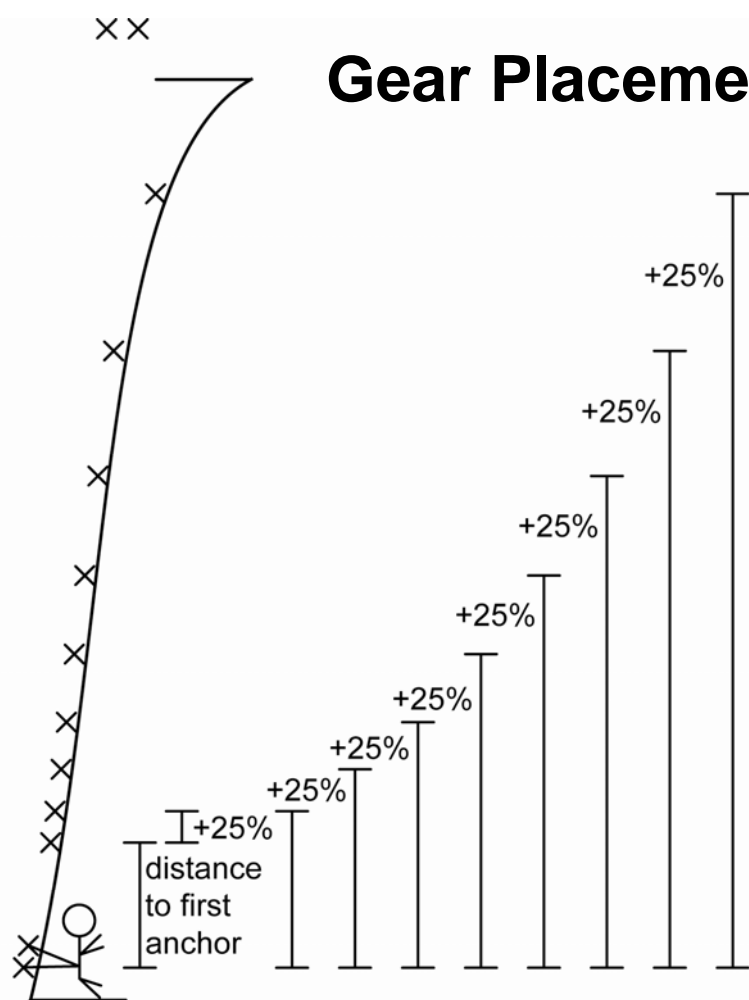

Anchor placement for trad leading based on the analysis by Stephen Attaway. To prevent gear failure, the leader must place gear when 25% above the last gear. This analysis does not include margin for the possible failure of the top gear, by poor placement or misadventure. In this example, if the first gear is 2 meters above the anchor, the total pitch length is less than 20 meters.

Anchor Placements

Place the anchor well below the hard moves and just below good gear placements.

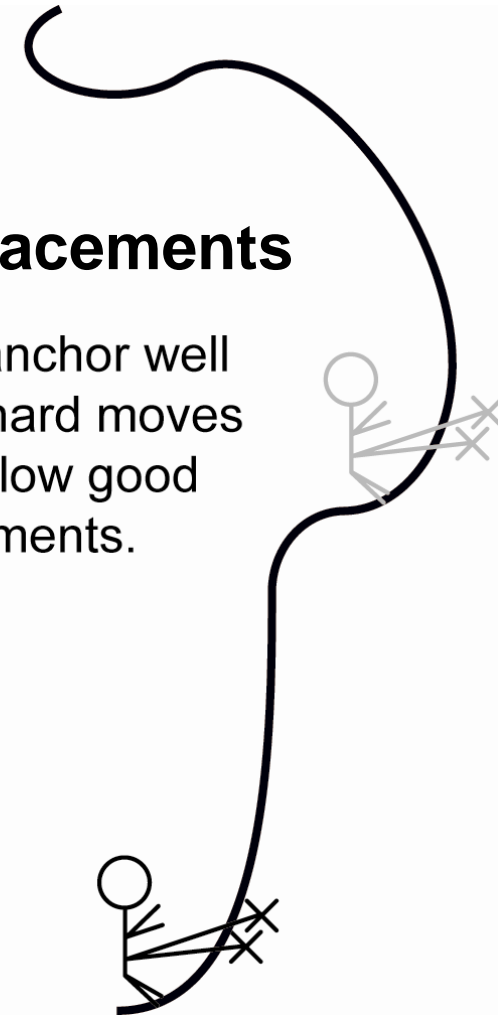

March 6, 2006

ES.255 Rope Behavior
Presentation

13

Statistical Analysis of Test Facility

Data: Expected Error

Table 1: Error Sources as specified in UIAA 108 and EN892

<i>Measurement</i>	<i>Symbol</i>	<i>Specification</i>	<i>%Error</i>
mass of falling weight	m/ϵ_m	80kg \pm 0.1	\pm 0.13%
speed of falling weight	v/ϵ_v	9.8m/s \pm 0.1	\pm 1.0%
rope length	l/ϵ_l	2500 mm \pm 20 and 50 mm \pm 10	\pm 0.9%
impact force measure	F/ϵ_F	\pm 1.0%	\pm 1.0%
controlled temperature	t/ϵ_t	20°C \pm 2	\pm 2.2%
controlled humidity	h/ϵ_h	65% \pm 2%	\pm 4%

$$\sqrt{\frac{hmv^2}{l}} \propto F$$

The summation of the total errors is:

$$\sqrt{\left(\frac{\sqrt{\epsilon_m^2 + 2\epsilon_v^2 + \epsilon_l^2 + \epsilon_t^2 + \epsilon_h^2}}{2}\right)^2 + \epsilon_F^2} = \epsilon_{total}$$

$$\sqrt{\left(\frac{\sqrt{(0.0013)^2 + 2(0.01)^2 + (0.009)^2 + (0.022)^2 + (0.04)^2}}{2}\right)^2 + (0.01)^2} = \pm 2.6\%$$

Table 2, Range (Precision) of *max-f* Measurement, Expressed as $\pm\%$.

An asterix (*) indicates no data or some other anomaly. Numbers in bold indicate a certified facility average that exceeds the $\pm 3\%$ error budget.

	APAVE	Stuttgart	EMPA	Vienna	BEAL	Edelrid	Lanex	Mammut*
<i>04 EN892 single A</i>	<i>0.67</i>	<i>1.30</i>	<i>0.63</i>	<i>0.75</i>				
<i>04 EN892 half B</i>	<i>1.21</i>	<i>0.98</i>	<i>0.84</i>	<i>1.44</i>				
<i>04 UIAA108 single C</i>	3.14	6.66	<i>1.97</i>	<i>2.11</i>				
<i>04 UIAA108 single D</i>	3.62	<i>1.08</i>	<i>0.77</i>	<i>1.03</i>				
<i>04 UIAA108 half E</i>	<i>1.50</i>	<i>0.89</i>	<i>1.12</i>	<i>1.09</i>				
<i>04 UIAA108 twin F</i>	<i>1.44</i>	<i>0.61</i>	<i>0.40</i>	<i>1.05</i>				
<i>03 EN892 single A</i>	<i>0.88</i>	<i>0.62</i>	<i>0.67</i>	<i>2.48</i>	<i>0.89</i>	<i>2.43</i>	<i>1.33</i>	<i>2.92</i>
<i>03 EN892 half B</i>	<i>1.22</i>	<i>0.92</i>	<i>0.37</i>	3.15	<i>3.01</i>	<i>2.71</i>	<i>3.97</i>	<i>3.93</i>
<i>03 UIAA108 single C</i>	*	<i>0.00*</i>	<i>1.17</i>	<i>1.55</i>	<i>2.84</i>	<i>1.29</i>	<i>2.83</i>	<i>4.50</i>
<i>03 UIAA108 single D</i>	*	<i>0.63</i>	<i>0.62</i>	<i>0.98</i>	<i>1.16</i>	<i>1.25</i>	<i>1.20</i>	<i>0.81</i>
<i>03 UIAA108 half E</i>	*	<i>0.92</i>	<i>0.18</i>	<i>0.94</i>	<i>1.14</i>	<i>2.67</i>	<i>2.38</i>	<i>3.69</i>
<i>03 UIAA108 twin F</i>	*	<i>0.63</i>	<i>0.37</i>	<i>1.12</i>	<i>0.88</i>	<i>2.48</i>	<i>0.64</i>	<i>3.32</i>
<i>03 UIAA108 twin G</i>	*	<i>1.07</i>	3.20	<i>0.54</i>	<i>1.15</i>	<i>4.29</i>	<i>1.58</i>	<i>3.58</i>
<i>03 average</i>	<i>1.05</i>	<i>0.68</i>	<i>0.94</i>	<i>1.54</i>	<i>1.58</i>	<i>2.44</i>	<i>1.99</i>	<i>3.25</i>
<i>03 std dev</i>	<i>0.24*</i>	<i>0.35</i>	<i>1.05</i>	<i>0.94</i>	<i>0.93</i>	<i>1.03</i>	<i>1.14</i>	<i>1.18</i>
<i>02 EN892 half C</i>	<i>1.50</i>	<i>0.00</i>	<i>0.74</i>	<i>0.53</i>	<i>2.00</i>	<i>1.84</i>	<i>1.03</i>	<i>3.66</i>
<i>02 EN892 half D</i>	<i>1.30</i>	<i>0.00</i>	<i>0.48</i>	5.48	<i>1.09</i>	<i>2.35</i>	<i>0.44</i>	<i>1.31</i>
<i>02 average</i>	<i>1.4</i>	<i>0.0</i>	<i>0.6</i>	<i>3.0</i>	<i>1.5</i>	<i>2.1</i>	<i>0.7</i>	<i>2.5</i>
<i>01 EN892 single</i>	<i>1.11</i>	<i>0.78</i>	<i>0.46</i>	<i>0.37</i>				
<i>01 EN892 half</i>	<i>0.88</i>	<i>0.45</i>	<i>0.47</i>	<i>0.11</i>				
<i>01 EN892 twin</i>	<i>0.81</i>	<i>1.25</i>	<i>1.75</i>	<i>1.98</i>				
<i>01 average</i>	<i>0.93</i>	<i>0.83</i>	<i>0.89</i>	<i>0.82</i>				
<i>01 std dev</i>	<i>0.16</i>	<i>0.40</i>	<i>0.74</i>	<i>1.01</i>				
<i>average of all averages</i>	<i>1.6</i>							
<i>std dev of all averages</i>	<i>1.2</i>							
<i>average all certified facility averages</i>	<i>1.2</i>							
<i>std dev all certified facility averages</i>	<i>1.1</i>							

Experimental Verification: Mägdefrau Data

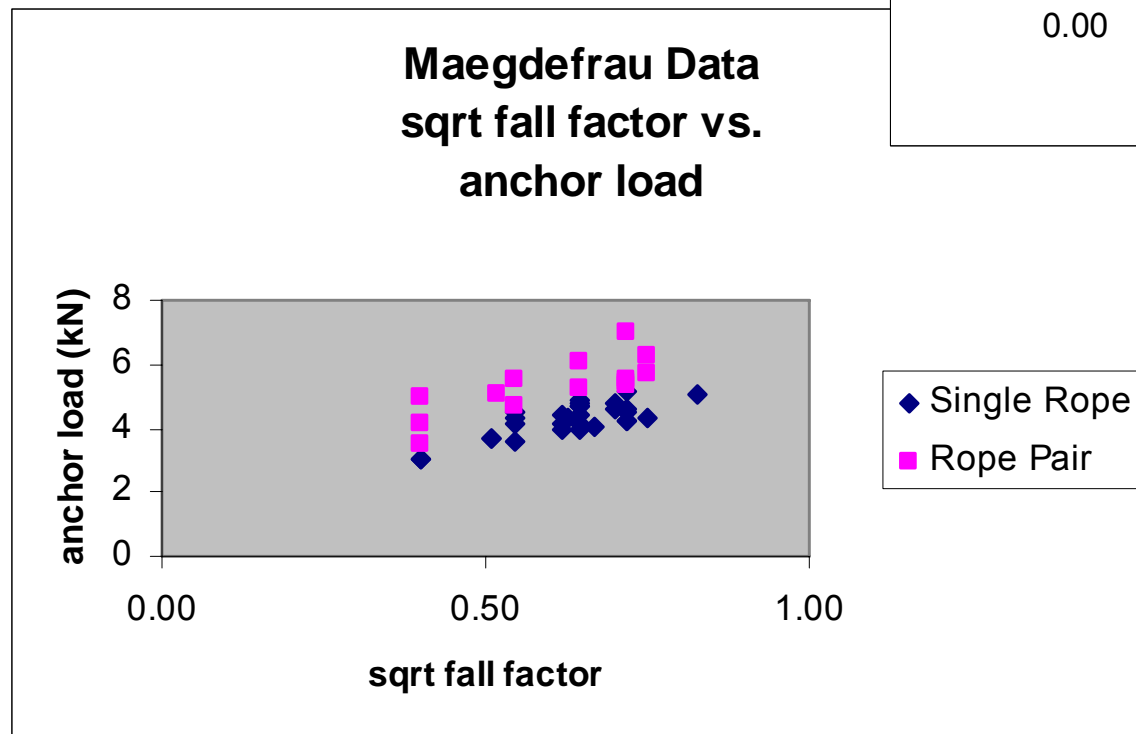
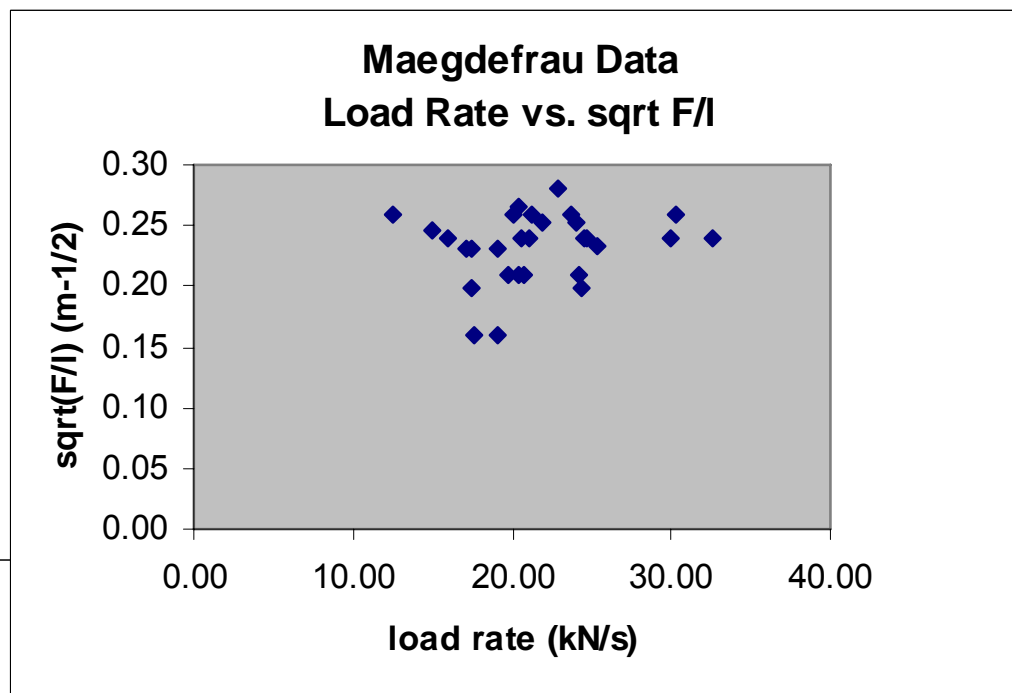

Effects of Humidity

See: A. B. Spierings, O. Henkel, and M. Schmid.
Water absorption and the effects of moisture on the dynamic properties of synthetic mountaineering ropes. International Journal of Impact Engineering 2005.

Effects on:

Drops Held: See Fig. 2

Force: See Fig. 3

Elongation: See Fig. 4

Bibliography/References

- M Pavier Experimental and theoretical simulations of climbing falls
- O. Henkel, M. Schmid, A.B. Spierings Water absorption and the effects of moisture on the dynamic properties of synthetic mountaineering ropes
- A Wexler, The theory of belaying
- UIAA, Standard 101, dynamic ropes
- S Attaway, Rope System Analysis
- C Zanantoni et al., UIAA SafeCom minutes

MIT OpenCourseWare
<http://ocw.mit.edu>

ES.255 Physics of Rock Climbing
Spring 2006

For information about citing these materials or our Terms of Use, visit: <http://ocw.mit.edu/terms>.