

Networks in System Architecture

- Network research history
- Example complex systems represented as networks
- Network models
 - Forming
 - Analyzing
- Some fundamental questions

Network Traditions and Emphases

- Common foundation in graph theory (Euler) and desire to represent relationships
- OR Optimization and Flow (1900s-1980s? Or now?)
 - Logistics, shortest **paths**, optimal allocation...
 - Ahuja, Magnanti, and Orlin
- Social Network Theory (1970s-now?)
 - Focus on relationships
 - Abstract models, seeking system structural insights from metrics: cliques, **clusters**, power brokers, gate-keepers
 - Wasserman and Faust
- “New” Network Science (1990s-now)
 - Abstract models, seeking system **structural** insights from metrics
 - Statistical approach
 - Barabasi, Watts, Newman

“New” Network Science

- Primary researchers are statistical physicists and mathematicians plus some social scientists and ecologists
- Differ from SNT and OR traditions
 - Averaging metrics over ensembles of graphs – metrics view
 - Modeling of network growth
 - Comparison to physical systems like critical point phenomena and percolation
 - Network vulnerability
 - New metrics
 - Erdős-Rényi random graphs as the normative basis
 - Interest in really big networks, so big that you can't display them, so only a metrics and statistical approach can be used
- Field seems immature, with some lack of consistent methods and standards of proof, but very dynamic, big mix of disciplines and methods, big ambitions...

Why Study Networks?

- Many systems are networks
- Networks capture relationships
- Networks have structure (possibly random)
- Various metrics exist that capture various aspects of this structure
- **In some cases** the structure or the metrics can be related to important properties of the system or its behavior

Modeling Questions

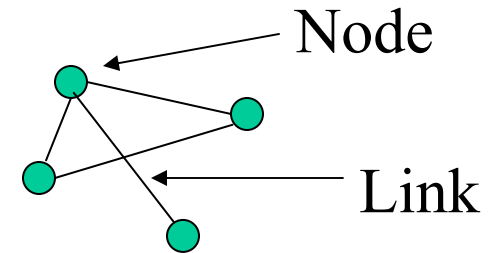

- What is a node?
- What is a link?
- What are the important relationships that a model should try to capture?
- What are the data that would be desired to build a useful model?
- How much of the data can you really get?
- What are fundamental limitations of the model?

Some Theoretical or Canonical Graph Types

- Planar
- Random
- Grid structured
- Trees
- Hub and spokes
- “Scale free”
- Possessing Hamilton or Euler circuit
 - Hamilton: touching every node once
 - Euler: touching every arc once

Example Graphs (Systems)

- Road map
- Electric circuit or pipe system
- Structure of bridge or building, with load paths
- Organizational chart or social network
- Markov chain
- Control circuit feedback loop
- Phone system
- Chemical reaction
- Sequential event plan

More Example Analyzable Graphs

- Manufacturing process
- Assembly sequence
- Schedule
- Family tree
- Ecological food chain
- Taxonomy of living things, rocks, and other natural hierarchies
- Naval battle, military campaign

Planar Graph Example

V = number of nodes

E = number of edges

f = number of facets

$f = E - V + 2$ (or 1 if the "outside" facet is ignored)

$E \leq 3V - 6$

$\therefore f_{\max} = 2V - 4$

Meshness Ratio $M = f / f_{\max}$ $0 \leq M \leq 1$

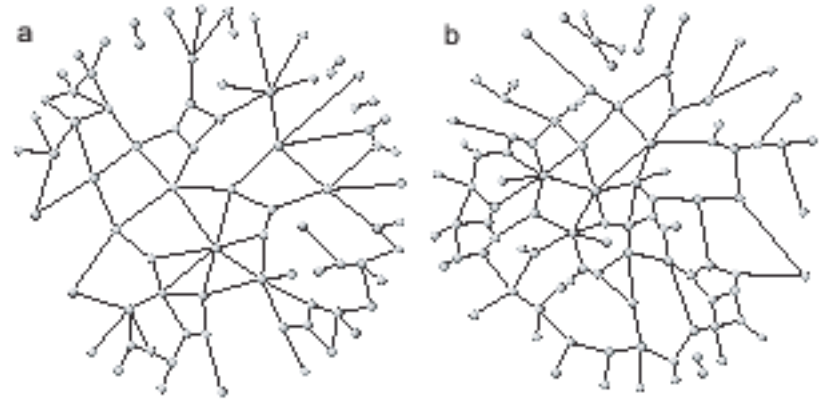
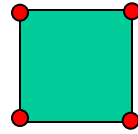

Trails made by ants in planar sand piles have average

nodal degree $\langle k \rangle = 2.2$ and $M \sim 0.1$

Note: for connected planar graphs:

$$\langle k \rangle_{\max} = \frac{6V - 12}{V} \xrightarrow{V \rightarrow \infty} 6$$

$$\langle k \rangle_{\min} = \frac{2V - 2}{V} \xrightarrow{V \rightarrow \infty} 2$$

Metro systems:

$\langle k \rangle = 3 - 3.5$

$mr = \sim 0.25$

$$\langle k \rangle \xrightarrow{V \rightarrow \infty} 4M + 2$$

“Efficiency and Robustness in Ant Networks of Galleries,”

J. Buhl, J. Gautrais¹, R.V. Sol'e, P. Kuntz, S. Valverde², J.L. Deneubourg, and G. Theraulaz,

Eur. Phys. J. B **42**, 123–129 (2004)

Network Analysis of Electric Circuits

This article does not use the word planar

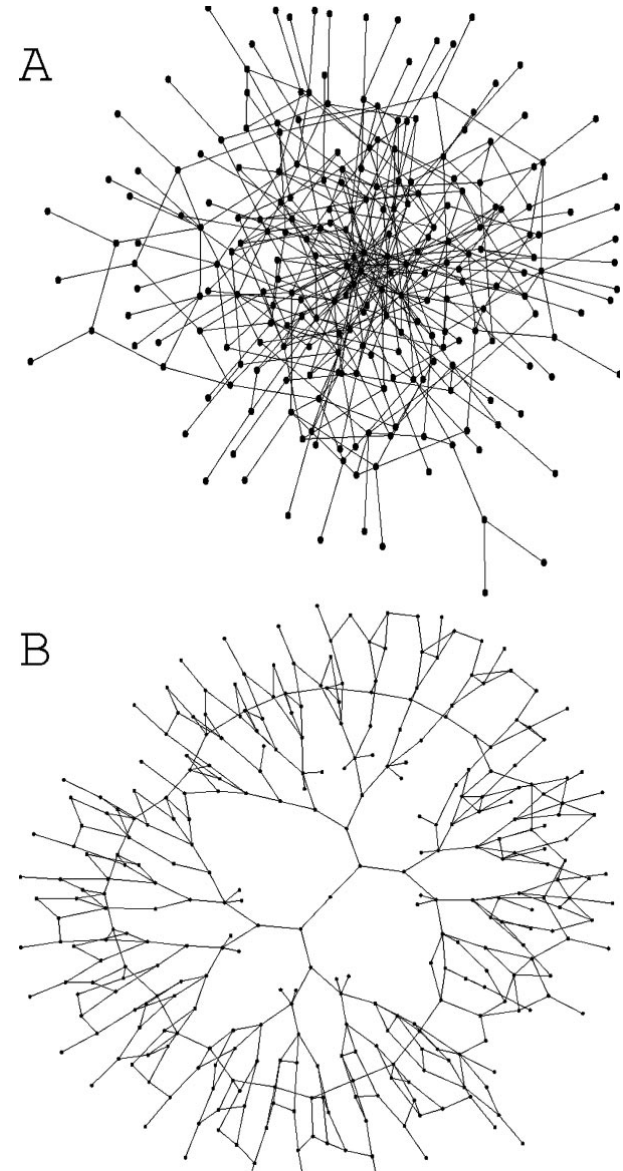
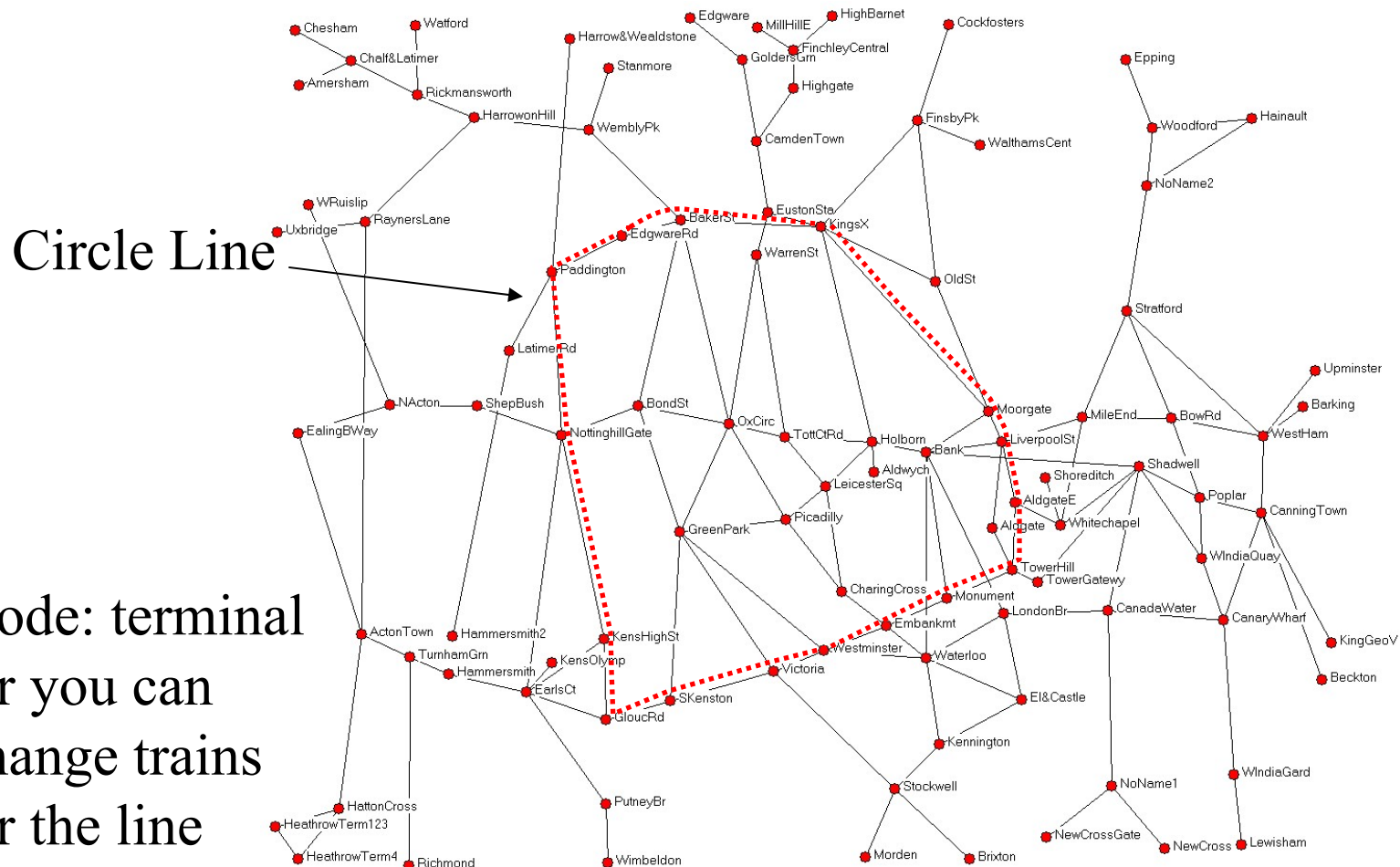

FIG. 3. (a) A lowly clustered logic circuit having $C=0.0013 < C^{rand}=0.015$ and $d=4.33 \approx d^{rand}=4.22$. The graph has $N=236$ vertices and $\langle k \rangle = 3.64$. (b) A highly clustered logic circuit having $C=0.053 > C^{rand}=0.0099$ and $d=5.06 \approx d^{rand}=4.99$. The graph has $N=320$ vertices, and $\langle k \rangle = 3.175$.

Topology of technology graphs: Small world patterns in electronic circuits, ÓRamon Ferrer i Cancho, Christiaan Janssen, and Ricard V. Sole, PHYSICAL REVIEW E, VOLUME 64 046119 § 1 th u - 5

Network Version of London Tube Map



A Circle Line Creates Shortcuts for Some Trips

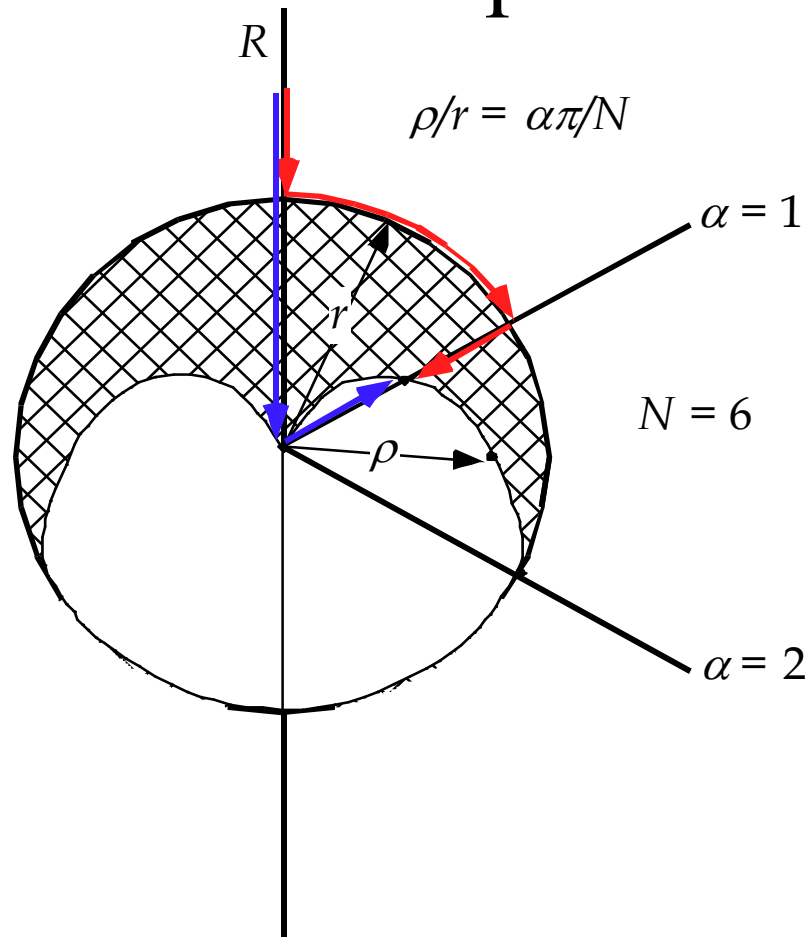

Growth Model of Tokyo Area Rail System by Slime Mold

Image of slime mold growth and diagram of Tokyo area rail system removed due to copyright restrictions.

Science 22 January 2010:
Vol. 327. no. 5964, pp. 439 - 442
DOI: 10.1126/science.1177894

Rules for Biologically Inspired Adaptive Network Design
Atsushi Tero,^{1,2} Seiji Takagi,¹ Tetsu Saigusa,³ Kentaro Ito,¹ Dan P. Bebber,⁴ Mark D. Fricker,⁴ Kenji Yumiki,⁵ Ryo Kobayashi,^{5,6} Toshiyuki Nakagaki,^{1,6,*}

Every (Network) Model Is a Choice of Level of Abstraction

- “High” abstraction
 - Summarize, generalize, compare
 - Don’t need domain knowledge
- “Low” abstraction
 - Valid detail
 - Explainable differences
 - Need domain knowledge
- Models and analyses at many levels are needed

Graphs and Networks

- A graph is a collection of nodes connected by arcs (directed, with arrows) or edges (undirected, no arrows) generically called links
- A network is a graph

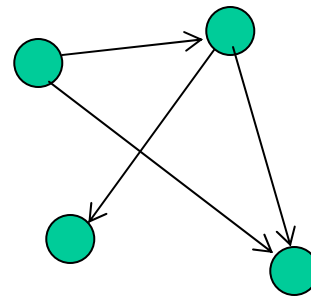
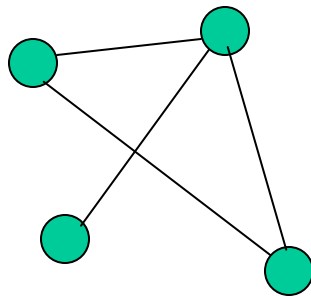

Graph/Network “Rules”

- Links connect pairs of nodes
- Links can be directed or undirected
 - Undirected called *edges* in graph theory
 - Directed called *arcs*
- Nodes can have any number of impinging links in principle, although there may be various constraints that depend on the domain
- Dual graphs can be formed
 - Links become nodes
 - Nodes become links

Nodes Can Be

- Places
- Things
- People
- Jobs, tasks, process steps
- Calculations or calculation steps

Links Can Be

- Physical paths, mechanical joints
- Abstract or real relationships
 - Directed: A commands B, is the father of B, occurs before B...
 - Undirected: A lives near B, is on the same side as B...
- Indications of flow of material or information
- Annotated to represent capacity, direction, content
- Carriers of single or multiple entities like geometric dimensions, kinds of stuff, etc

Various classes of networks

an undirected network
with only a single type of
node and a single type of
link

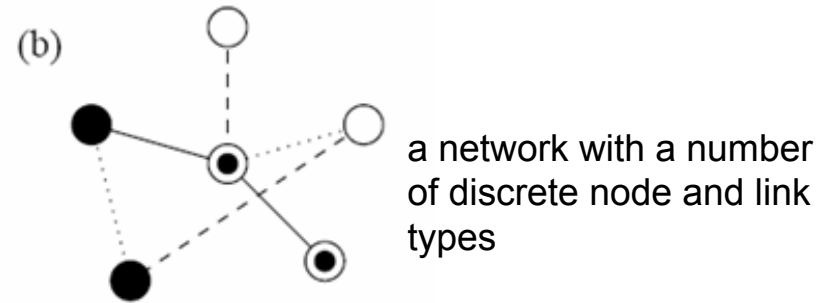
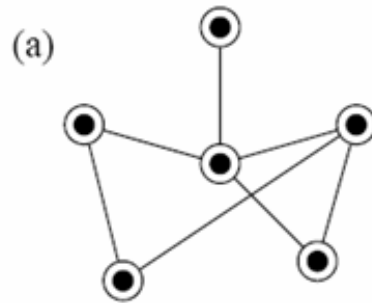

a network with
varying node and
link weights

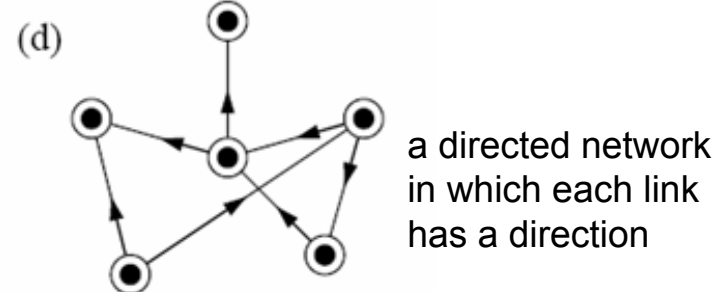
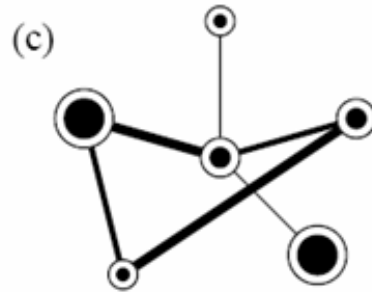

Missing are networks that have nodes with multiple functions and that have multiple types of links. For example, nodes that transform energy and also calculate and that have links that pass information, control signals, energy, etc.

Source: M. E. J. Newman, The Structure and Function of Complex Networks, *SIAM Review*, Vol. 45, No. 2, pp . 167–256, 2003
Society for Industrial and Applied Mathematics

Graphs Can Be Classified As...

- Metric (links have real lengths, and node locations obey the triangle inequality)
- Non-metric (the layout is purely logical)
- Cyclic or non-cyclic
- Planar (can be drawn so that no links cross)
- Connected or unconnected
 - Connected: a path exists between every pair of nodes
- Simple: no self-loops, ≤ 1 link between nodes
- Able/unable to support a looped path or a path that touches every node once only, ...
- These are not mutually exclusive

A Classification of Network Structures

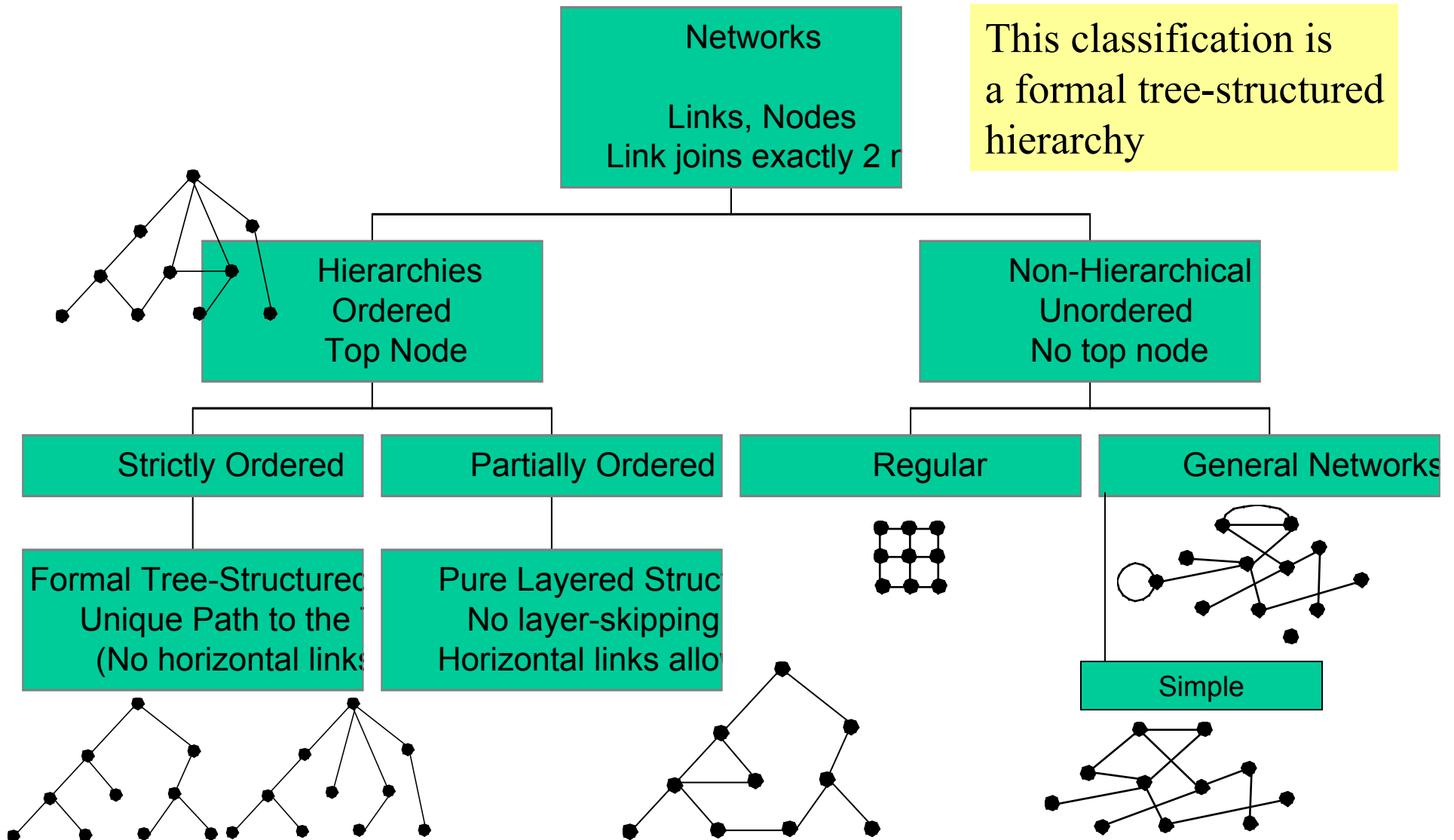

This classification is a formal tree-structured hierarchy

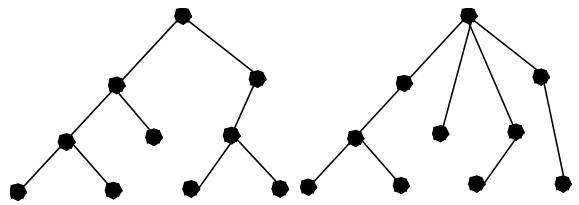

Networks_Intro.ppt

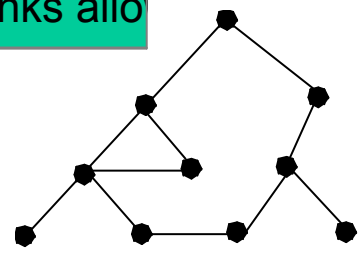

© Daniel E. Whitney

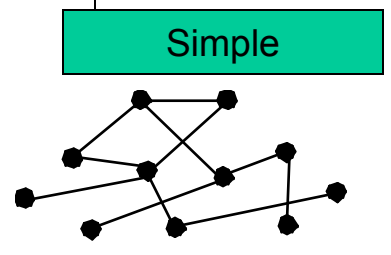
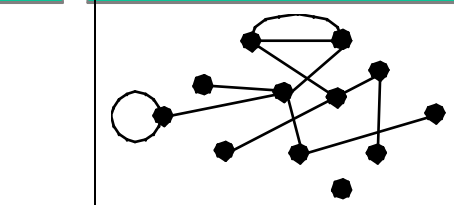

Real and “Not Real” Networks

- Real: road network, mechanical assembly
- Not real(?): coauthor or movie actor network
- Real but documentable only in a statistical sense: transmission of flu or rumors, number of friends
- Real = transitive relations?
- Much depends on the word ‘also’
 - A writes a paper with B and also one with C
 - A writes a paper with B and C
 - A reacts with B and also with C
 - A is bolted to B and also bolted to C
 - B sends signals to A which also sends signals to C
 - B eats A which also eats C

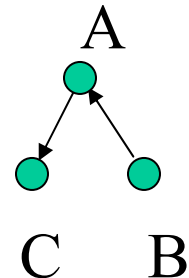
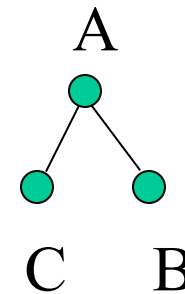

Bipartite Graphs

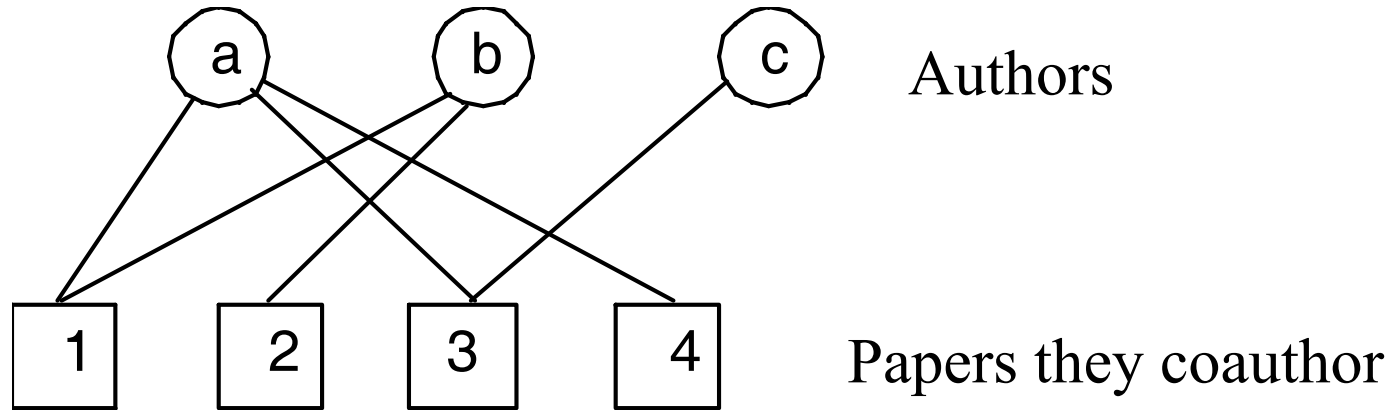

Author-author projection

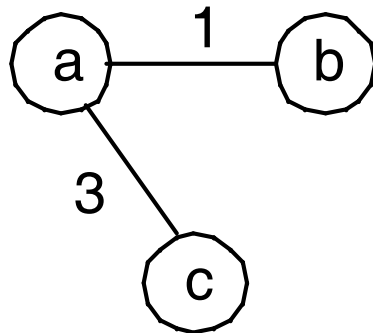

Nodes 1 and 3 have one pair of edges

Paper-paper projection

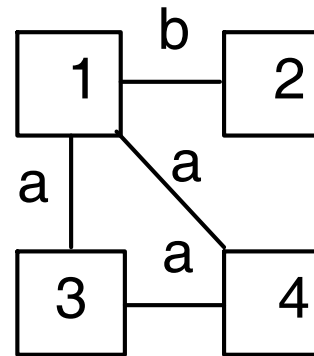

Node a has 3 pairs of edges; node b has one

Possible Analyses

- Finding an ordering on the nodes
 - Schedule, seating arrangement, space allocation, assembly sequence
- Finding clusters and communities
- Analyzing electric circuits and other applications of linear algebra
- Calculating mechanism properties like mobility and constraint
- Calculating control system stability
- Estimating or calculating system complexity
- Paths: shortest, max capacity, least cost, critical, first passage time, etc. Second place, 3rd place, etc

“Motifs” in Networks: Local Structure

Image removed due to copyright restrictions. Figure from: “Network Motifs: Simple Building Blocks of Complex Networks,” R. Milošević, S. Shen-Orr, S. Itzkovitz, N. Kashtan, D. Chklovskii, U. Alon, *Science* vol 298, 25 Oct 2002, p 864,

“Scale Free” Networks

- Also known as obeying a power law
- This can mean many things
- Usually it means that a list of a network’s nodal degrees can be represented as

$$pr(k) = k^{-\gamma}$$

where $pr(k)$ the notation means the probability that a node has k neighbors

“Scale free” also means that there is no definite range in which k exists or that the same pattern can be found at any level of magnification

Size Distribution of Earthquakes

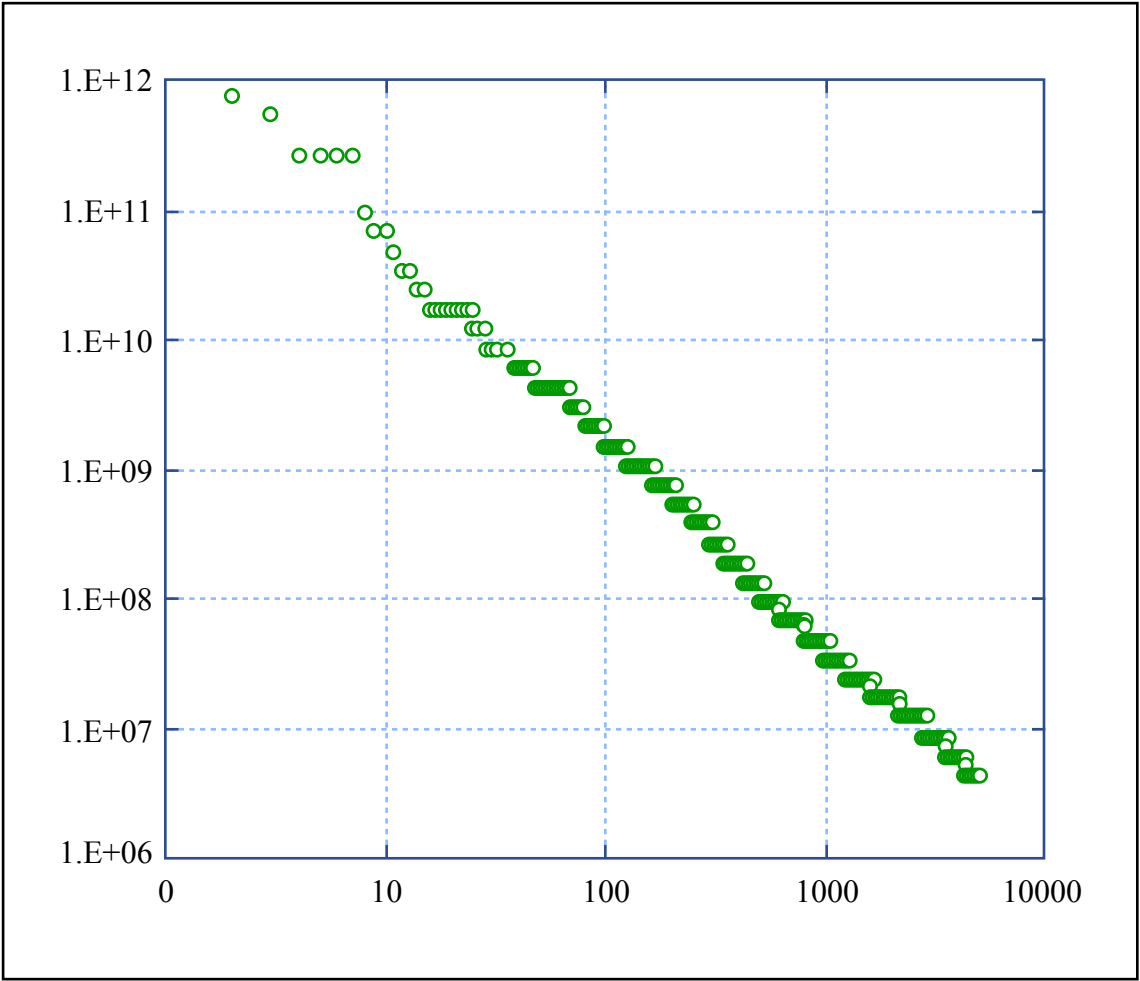

Image by MIT OpenCourseWare.

<http://enthusiasm.cozy.org/images/>

The chart shows one point for each of the top five thousand earthquakes in the united states dur

The Aura of Scale Free

- From ~1998 to 2004 (still!) there was a frenzy of publication in which one system after another was “discovered” to be scale free: “obeys a power law”
- It was claimed that these systems must have some underlying common elements or principles or have a particular hub-spokes structure and that the hubs had special roles in the systems
- The reality may be less exciting: there are many systems with high variability but they have not gotten much attention before.
- In any case, the degree sequences are scale free, not the networks themselves
- Many graphs have the same degree sequence and totally different structure

More Normal Than Normal

- Normal = gaussian distribution
- Usually the first assumption but not the only one possible or even most appropriate
 - A narrow distribution
- “The Black Swan: The Impact of the Highly Improbable”
 - A wide distribution

Links Between Networks and Systems

- Abstract model that captures relationships
- Hierarchical descriptions
- General network descriptions
- Depiction of the decomposition process as a tree
- Depiction of the synthesis process as clustering
- Early thinkers: Simon, Alexander

Alexander's Depiction of System Design

 <p>Performance Simplicity Jointing Economy</p>	<p>Requirements conflict</p>	 <p>Entire village</p> <p>A B C D</p> <p>A1 A2 A3 B1 B2 B3 B4 C1 C2 D1 D2 D3</p> <p>Result of clustering many conflicting requirements</p> <p>C. Alexander <i>Notes on the Synthesis of Form</i>, Cambridge: Harvard U Press, 1964</p>
	<p>A system and its internal relationships</p>	
	<p>Good partition</p>	
	<p>Bad partition</p>	

Image by MIT OpenCourseWare.

- Simon: modularity related to evolution, survival, and complexity (1962)
 - Can't survive (due to propagating failures) unless there is some independence between modules
 - The modules form into (nested/closed) hierarchies
 - Evolution can proceed in separate activities
 - Also: decomposable systems are less complex
- Alexander: modularity related to efficient design procedures (1964)
 - Can't make design decisions (due to interactions) unless they are clustered meaningfully and dealt with in bulk
 - Design can proceed as independent steps
 - The right clusters may not be the obvious visible ones
- Both: perfect clean decomposition is impossible

Possible Data Sets

- Western Power Grid
- Example at the end of Alexander *Notes on the Synthesis of Form*
- Most any road map
- Coauthors, metabolites
- Pajek web site (huge networks)

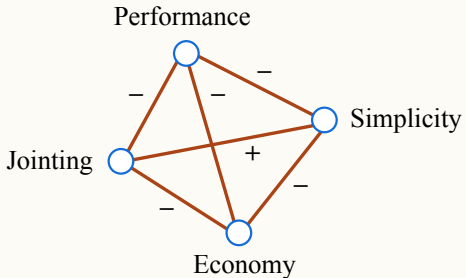
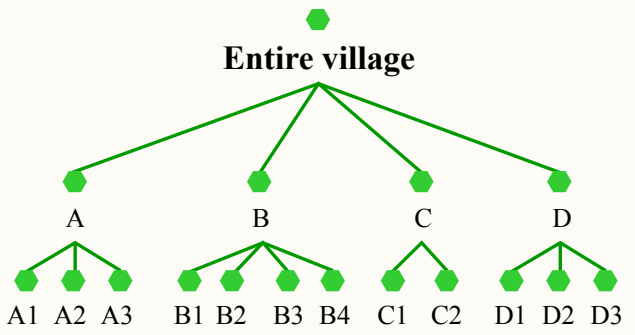
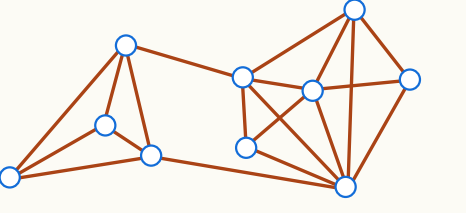
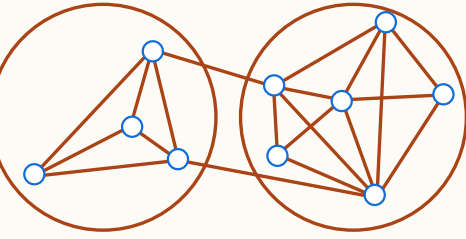
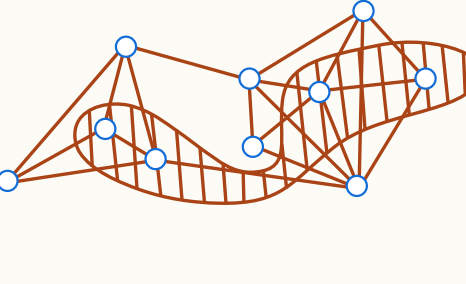
Research Front Topics

- To what extent are intuitively important aspects of architecture quantifiable and measurable?
- Are there useful paradigms, patterns, principles or other lessons from natural systems that researchers on real system architectures can use - and how can they be used?
- Assuming we know what functions, performance, andilities we want, what methods can be used to create a suitable architecture?
- Assuming we know what architecture we want, what are the most effective ways of influencing the architecture of complex, evolving engineering systems?

Graphs and Matrices

- A graph can be converted to a matrix and vice versa: node-node, node-link, link-link
- A graph where a link connects only 2 nodes is equivalent to a 2 dimensional matrix
- A graph where an link connects n nodes is equivalent to an n dimensional matrix
- When form or structural patterns must be observed, matrices may be the better representation, especially if there are very many nodes and links
- MATLAB is applicable

Matlab Routines (Next Class)

- On Stellar there are several Matlab routines that calculate many of these simple statistics
- Of course you can write your own.
- I have downloaded many Matlab graph theory routines but many seem to have bugs or do not work the way I expect.
- Always test any routine on a simple graph first

Tutorial Book

- <http://faculty.ucr.edu/~hanneman/nettext/index.html>
- Linked to UCINET software
<http://www.analytictech.com/ucinet/>

Resources, with search paths

- Google>graph theory>
 - <http://people.freenet.de/Emden-Weinert/graphs.html>
 - <http://www.c3.lanl.gov/mega-math/gloss/graph/gr.html>
 - <http://www.utm.edu/departments/math/graph/>
 - <http://mathworld.wolfram.com/topics/GraphTheory.html>
- Google>social science network analysis>
 - <http://www.insna.org/software/index.html>
 - <http://www.research.att.com/sw/tools/graphviz/> (found on INSNA/soft_inf, software toolkit for drawing graphs and networks)
- Google> graph theory analysis software>
 - <http://www-personal.umich.edu/~mejn/courses/2004/cscs535/> (Mark Newman's course at U of M)
 - <http://eclectic.ss.uci.edu/~drwhite/Anthro179a/SocialDynamics02.html> >
<http://eclectic.ss.uci.edu/~drwhite/>
 - http://directory.google.com/Top/Science/Math/Combinatorics/Software/Graph_Drawing/

More Resources

- Google> graph theory analysis software>
 - <http://www.ece.uc.edu/~berman/gnat/> (a research group)
 - http://mathforum.org/library/topics/graph_theory/?keyid=10077171&start_at=51&num_to_see=50 (The Math Forum @ Drexel)
 - <http://www.ai.mit.edu/~murphyk/Bayes/bayes.html> (Bayesian belief networks)
 - <http://www.math.niu.edu/~rusin/known-math/index/05-XX.html> (combinatorics) > <http://www.math.niu.edu/~rusin/known-math/index/05CXX.html> (graph theory)
 - http://www.indiana.edu/%7Ecortex/connectivity_toolbox.html (matlab toolbox)
 - <http://www.mathworks.com/matlabcentral/fileexchange/4266-grtheory-graph-theory-toolbox> (another matlab toolbox)
 - <http://jung.sourceforge.net> (a java toolkit)
 - <http://www-personal.umich.edu/~mejn/pubs.html> (Mark Newman's publications)

More

- <http://powerlaws.media.mit.edu/> (MIT course with pdf readings)
- <http://nicomedia.math.upatras.gr/courses/mnets/> (Univ of Patras course with readings)
- http://en.wikipedia.org/wiki/Small_world_phenomenon#The_scale-free_network_model

Prominent Network Researchers

- Barabasi <http://www.nd.edu/~alb/>
- Doyle <http://www.cds.caltech.edu/~doyle/>
 - <http://www.cds.caltech.edu/~doyle/CmplxNets/>
 - <http://hot.caltech.edu/>
- Newman <http://www-personal.umich.edu/~mejn/>
- Strogatz <http://tam.cornell.edu/Strogatz.html>
- Watts <http://www.coi.columbia.edu/faculty.html>

Backups

Ship Steam System

Mechanical Drawing

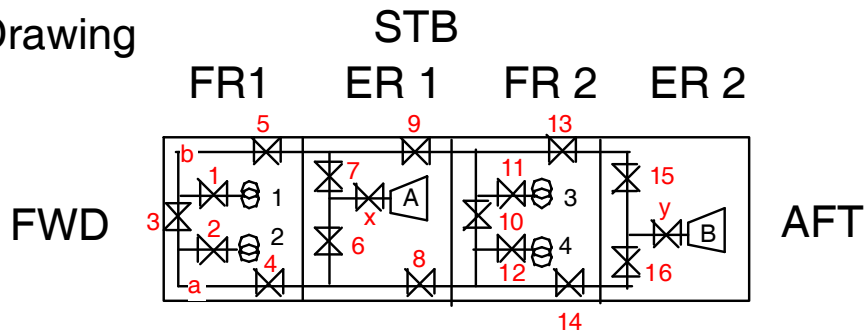

Network Graph

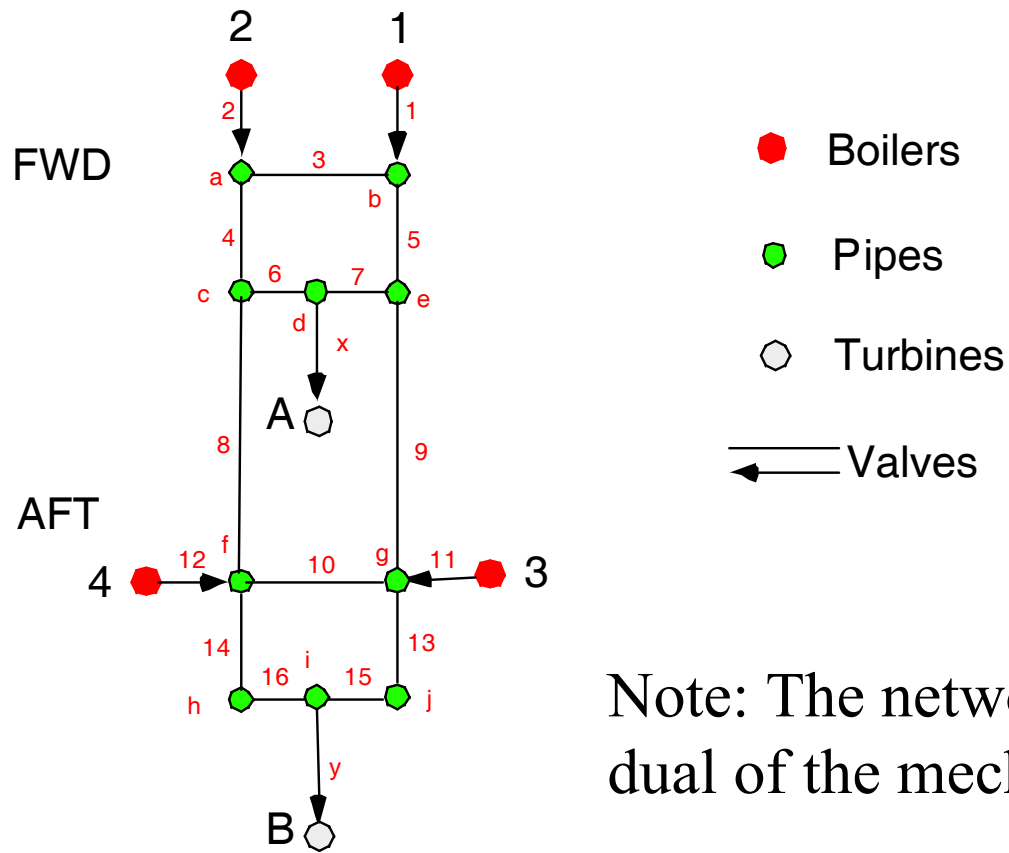

Note: The network graph is the dual of the mechanical drawing

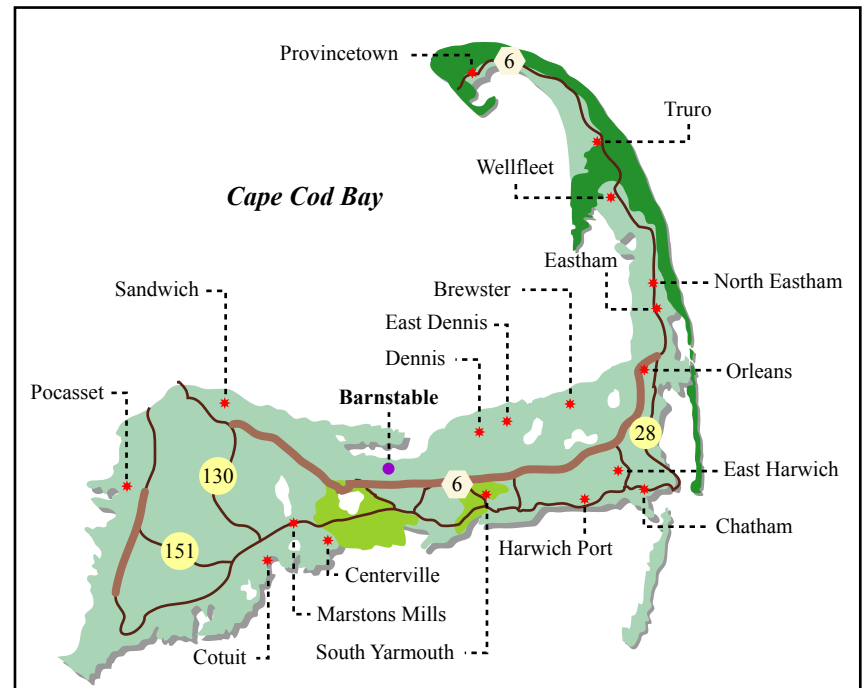
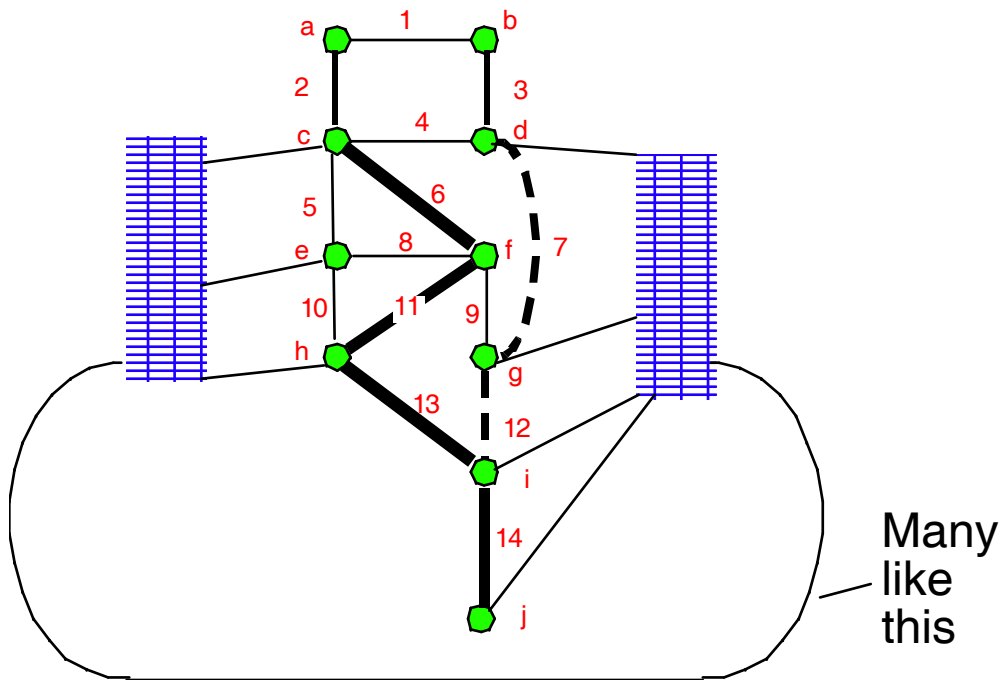
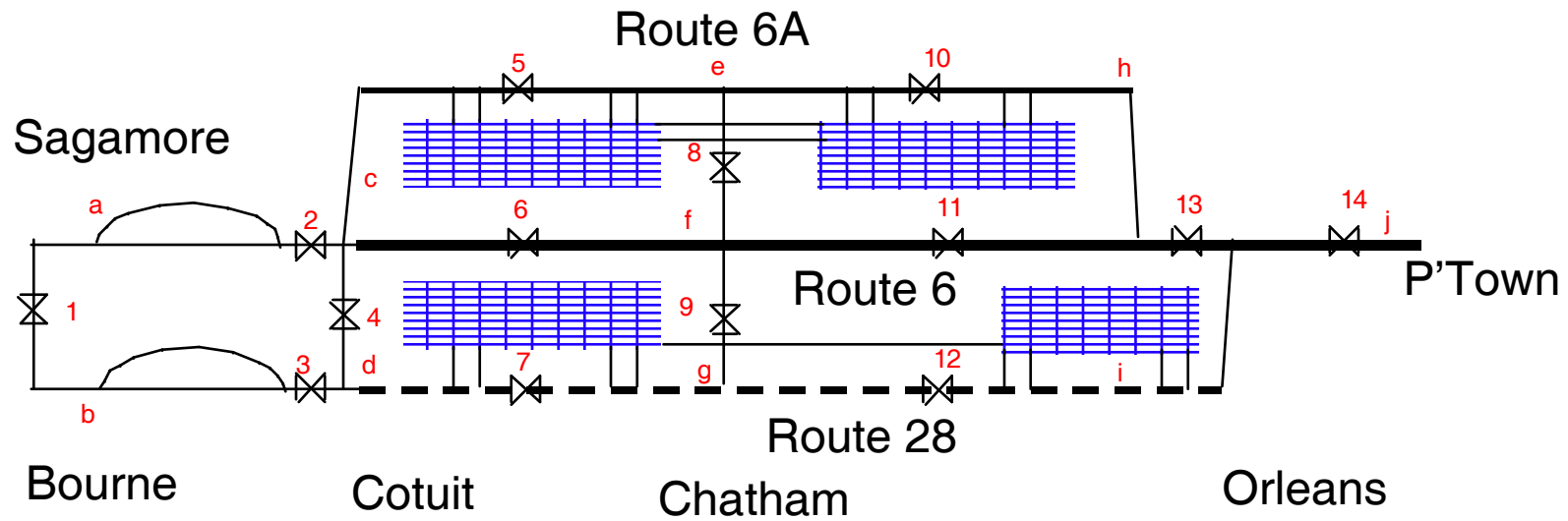
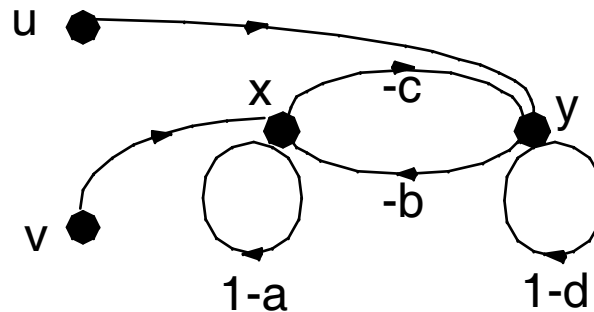

Image by MIT OpenCourseWare.

Cape Cod Roadways

Link Between Networks and Linear Algebra



$$\begin{bmatrix} u \\ v \end{bmatrix} = \begin{bmatrix} a & b \\ c & d \end{bmatrix} \begin{bmatrix} x \\ y \end{bmatrix}$$

“Solve” for x and y given u and v by putting voltages on the u and v terminals and reading the voltages on the x and y terminals

Diameter and Structure

- How many plane changes are needed to fly from city A to city B and how does this change as the network grows?
- In a point to point network, the number might grow linearly with the number of cities in the network, unless there is a link between most pairs (max $n(n-1)/2$ links needed)
- In a hub-spokes network, the number may hardly grow at all even if almost no cities are directly linked
- Of course, the distance flown and time spent flying and waiting are longer for hub-spokes

Advantages of Graph Representations

- Abstraction
- Sharp focus on relationships
- Ability to calculate many relevant properties of the modelled system, including many that accommodate huge graphs

Disadvantages

- Limited kinds of structures can be represented
 - Can't handle ternary relationships
- Multiple properties often require separate graphs
- Nodes and links are usually treated as identical
 - Exceptions: links with costs, bounded flow or one-way flow, nodes classified as toll-takers, sources, sinks, and pass-throughs
- Theory does not deal with the graph as a whole the way, say, set theory does

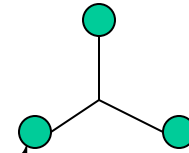

MIT OpenCourseWare
<http://ocw.mit.edu>

ESD.342 Network Representations of Complex Engineering Systems
Spring 2010

For information about citing these materials or our Terms of Use, visit: <http://ocw.mit.edu/terms>.