

ESD.33 -- Systems Engineering

# Session #10

## Design of Experiments

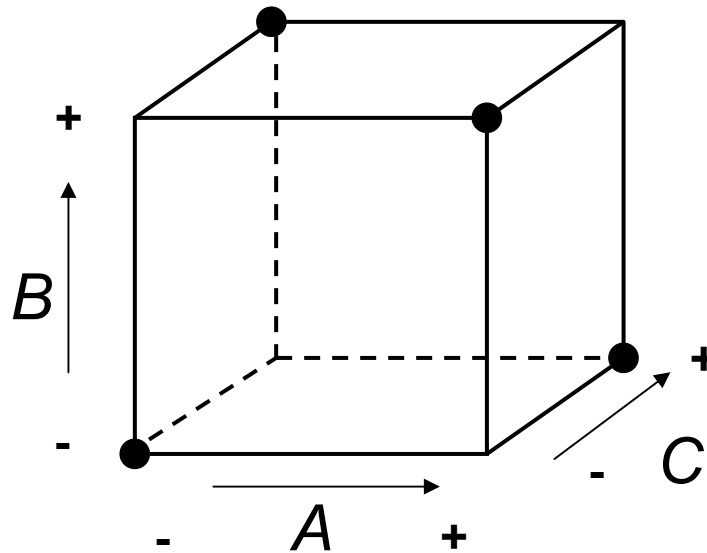

Dan Frey



# Plan for the Session

## Thomke -- Enlightened Experimentation

- Statistical Preliminaries
- Design of Experiments
  - Fundamentals
  - Box – Statistics as a Catalyst
  - Frey – A role for one factor at a time?
- Next steps

# 3D Printing

1. The Printer spreads a layer of powder from the feed box to cover the surface of the build piston.
2. The Printer then prints binder solution onto the loose powder.
3. When the cross-section is complete, the build piston is lowered slightly, and a new layer of powder is spread over its surface.
4. The process is repeated until the build is complete.
5. The build piston is raised and the loose powder is vacuumed away, revealing the completed part.

# 3D Computer Modeling

- Easy visualization of 3D form
- Automatically calculate  
physical properties
- Detect interferences in assy
- Communication!
- Sometimes used in milestones

# Thomke's Advice

- Organize for rapid experimentation
- Fail early and often, but avoid mistakes
- Anticipate and exploit early information
- Combine new and traditional technologies

# Organize for Rapid Experimentation

- BMW case study
- What was the enabling technology?
- How did it affect the product?
- What had to change about the process?
- What is the relationship to DOE?

# Fail Early and Often

- What are the practices at IDEO?
- What are the practices at 3M?
- What is the difference between a “failure” and a “mistake”?

# Anticipate and Exploit Early Information

- Chrysler Case study
- What was the enabling technology?
- How did it affect the product or process?
- What is the relationship to DOE?



# Relative cost of correcting an error

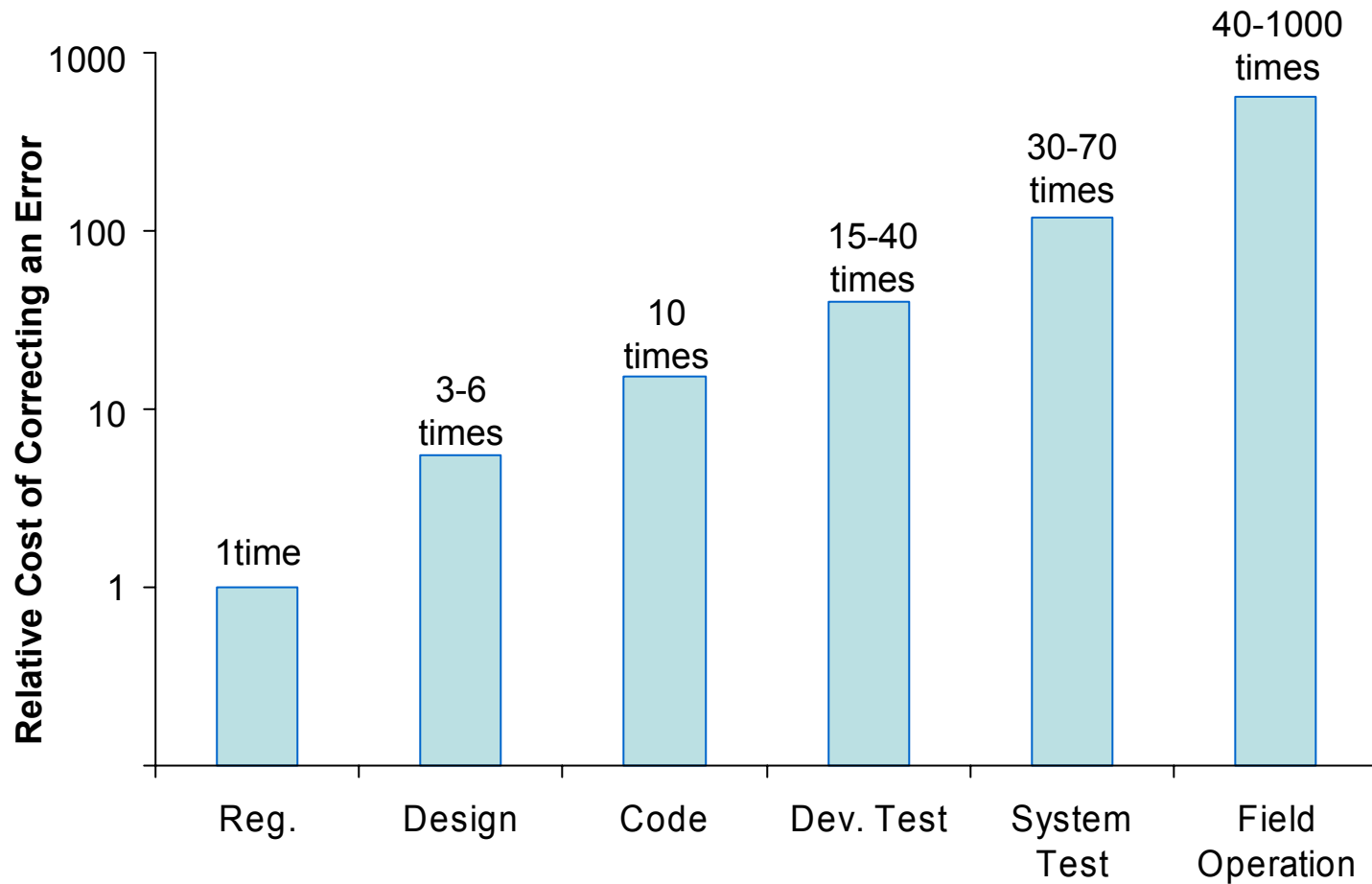

# Combine New and Traditional Technologies

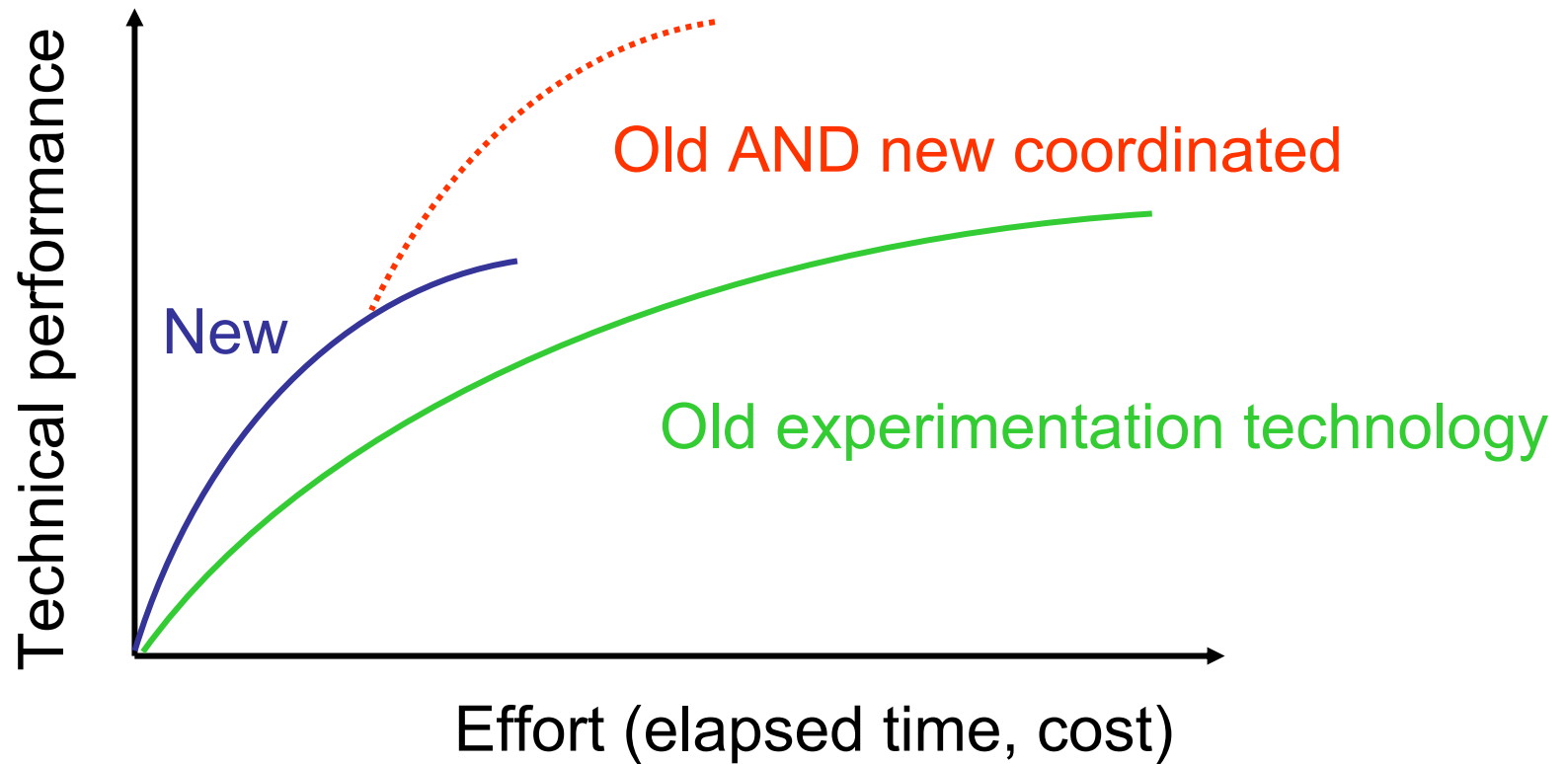

# Enlightened Experimentation

- New technologies make experiments faster and cheaper
  - Computer simulations
  - Rapid prototyping
  - Combinatorial chemistry
- Thomke's theses
  - Experimentation accounts for a large portion of development **cost and time**
  - Experimentation technologies have a strong effect on **innovation** as well as refinement
  - Enlightened firms think about their **system for experimentation**
  - Enlightened firms **don't forget the human factor**

# Plan for the Session

- Thomke -- Enlightened Experimentation

## Statistical Preliminaries

- Design of Experiments
  - Fundamentals
  - Box – Statistics as a Catalyst
  - Frey – A role for one factor at a time?
- Next steps

# Statistics and Probability

Probability theory is axiomatic. Fully defined probability problems have unique and precise solutions...

The field of statistics is different. Statistics is concerned with the relation of such models to actual physical systems. The methods employed by the statistician are arbitrary ways of being reasonable in the application of probability theory to physical situations.

# Systems Engineering

An interdisciplinary approach and means to enable the realization of successful systems.

Design of Experiments

Statistics

Philosophy

Probability

Mathematics

Science

Engineering

History

Issues to grapple with today:

- What are some of the techniques at the intersection of SE with statistics?
- What can SE learn from the history of statistics?
- How can SE find its epistemic basis (partly) via statistics?

# Analyzing Survey Results

- I asked how many hours per week you spend on ESD.33
- The responses
  - times=[15, 12.5, 15, 20, 17.5, 12, 15, 12, 15, 14, 20, 12, 16, 16, 17, 15, 20, 14, 17.5, 9, 10, 16, 12, 20, 17]
  - $\mu=15.2$ ,  $\sigma=3.1$
- Is my plan to switch to 9 units (12 hrs/wk) on track? `[h,p,ci,stats] = ttest(times,12,0.05,'right')`
- Am I on track for 12 units (16 hrs/wk)? `[h,p,ci,stats] = ttest(times,16,0.05,'both')`

# Neyman-Pearson Framework

- Probability of Type I Error

$$E(P(\delta(\mathbf{X}) = 1)) \text{ if } \theta \in \Theta_0$$

- Probability of Type II Error

$$E(P(\delta(\mathbf{X}) = 0)) \text{ if } \theta \in \Theta_1$$

- In the N-P framework, probability of Type II error is minimized subject to Type I error being set to a fixed value  $\alpha$



# Concept Test

- This Matlab code generates data at random (no treatment effects)
- But assigns them to 5 different levels
- How often will ANOVA reject  $H_0$  ( $\alpha=0.05$ )?

```
for i=1:1000
    X=random('Normal',0,1,1,50);
    group=ceil([1:50]/10);
    [p,table,stats] = anova1(X, group,'off');
    reject_null(i)=p<0.05;
end
mean(reject_null)
```

- 1) ~95% of the time
- 2) ~5% of the time
- 3) ~50% of the time
- 4) Not enough info
- 5) I don't know

# Regression

- Fit a linear model to data & answer certain statistical questions

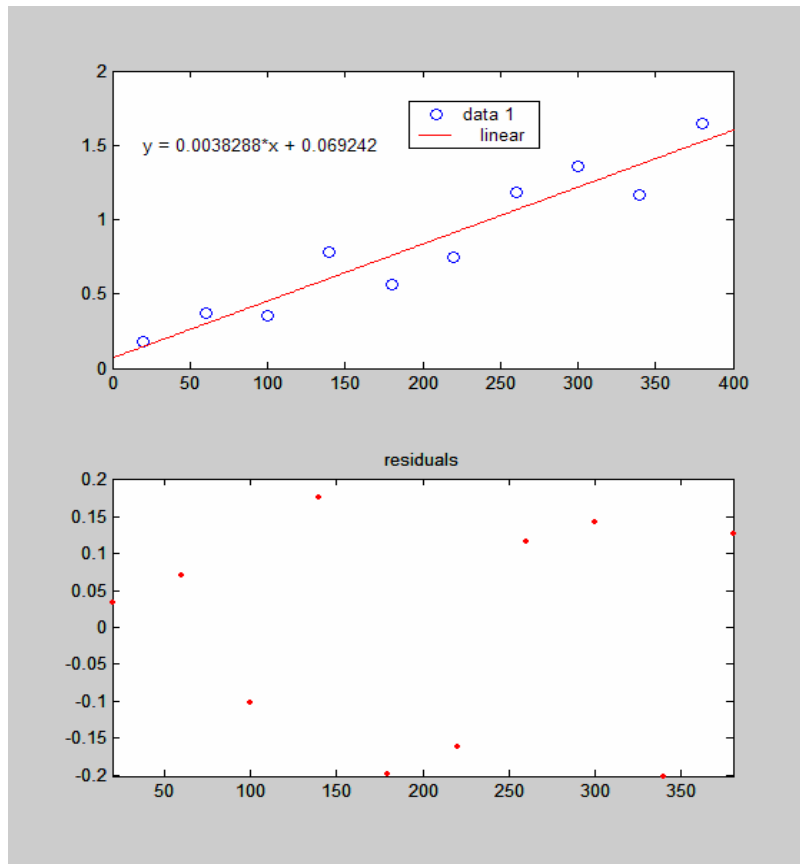

Air vel (cm/sec)	Evap coeff. (mm <sup>2</sup> /sec)
20	0.18
60	0.37
100	0.35
140	0.78
180	0.56
220	0.75
260	1.18
300	1.36
340	1.17
380	1.65

# Evaporation vs Air Velocity

## Confidence Intervals for Prediction

Air vel (cm/sec)	Evap coeff. (mm <sup>2</sup> /sec)
20	0.18
60	0.37
100	0.35
140	0.78
180	0.56
220	0.75
260	1.18
300	1.36
340	1.17
380	1.65

```
[p,S] = polyfit(x,y,1);  
alpha=0.05;  
[y_hat,del]=polyconf(p,x,S,alpha);  
plot(x,y,'+',x,y_hat,'g')  
hold on  
plot(x,y_hat+del,'r:')  
plot(x,y_hat-del,'r:')
```

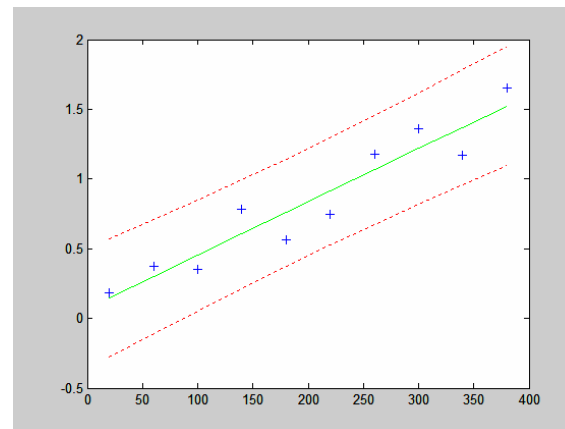

# Correlation versus Causation

- Correlation – an observed association between two variables
- Lurking variable – a common cause of both effects
- Causation – a deliberate change in one factor will bring about the change in the other

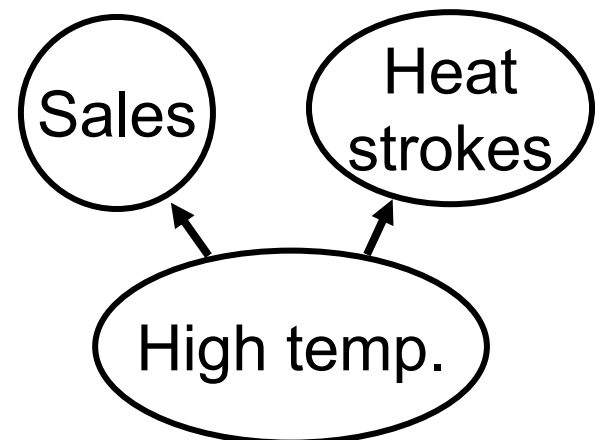

# Discussion Topic

- ~1950 a study at the London School of Hygiene states that smoking is an important cause of lung cancer because the chest X-rays of smokers exhibit signs of cancer at a higher frequency than those of non-smokers
- Sir R. A. Fisher wrote
  - “...an error has been made of an old kind, in arguing from correlation to causation”
  - “For my part, I think it is more likely that a common cause supplies the explanation”
  - Argued against issuance of a public health warning

R. A. Fisher, 1958, *The Centennial Review*, vol. II, no. 2, pp. 151-166.

R. A. Fisher, 1958, Letter to the Editor of *Nature*, vol. 182, p. 596.

# Plan for the Session

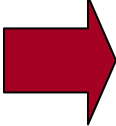
- Thomke -- Enlightened Experimentation
- Statistical Preliminaries
- Design of Experiments
-  Fundamentals
  - Box – Statistics as a Catalyst
  - Frey – A role for one factor at a time?
- Next steps

# Design of Experiments

- Concerned with
  - Planning of experiments
  - Analysis of resulting data
  - Model building
- A highly developed technical subject
- A subset of statistics?
- Or is it a multi-disciplinary topic involving cognitive science and management?

# Basic Terms in DOE

- **Response** – the output of the system you are measuring (e.g. range of the airplane)
- **Factor** – an input variable that may affect the response (e.g. location of the paper clip)
- **Level** – a specific value a factor may take
- **Trial** – a single instance of the setting of factors and the measurement of the response
- **Replication** – repeated instances of the setting of factors and the measurement of the response
- **Effect** – what happens to the response when factor levels change
- **Interaction** – joint effects of multiple factors



# Cuboidal Representation

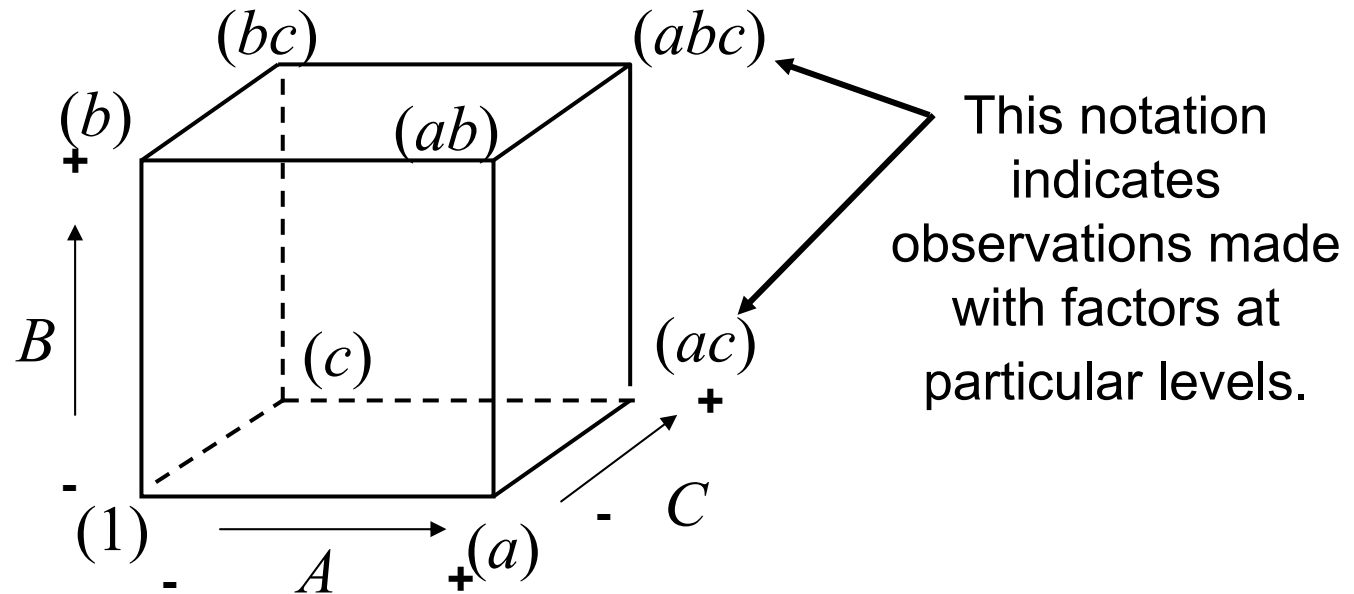

Exhaustive search of the space of  
3 discrete 2-level factors is the  
**full factorial  $2^3$  experimental design**

# One at a Time Experiments

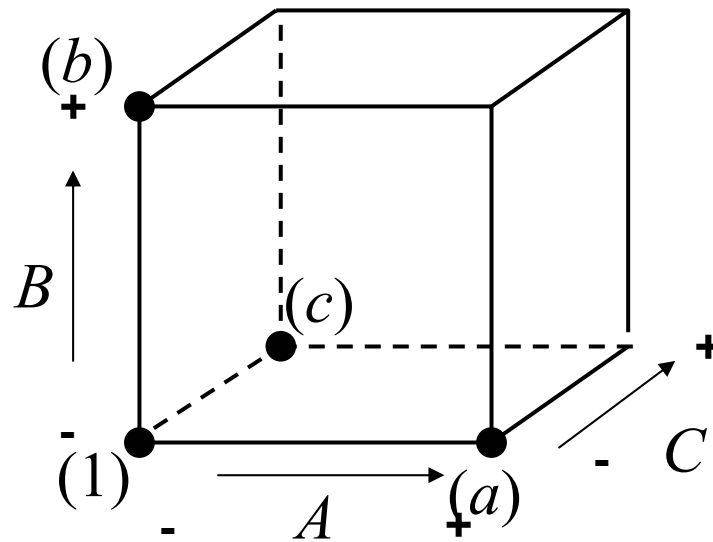

If the standard deviation of  $(a)$  and  $(1)$  is  $\sigma$ , what is the standard deviation of  $A$ ?

Provides resolution of individual factor effects  
But the effects may be biased

$$A \approx (a) - (1)$$

# Calculating Main Effects

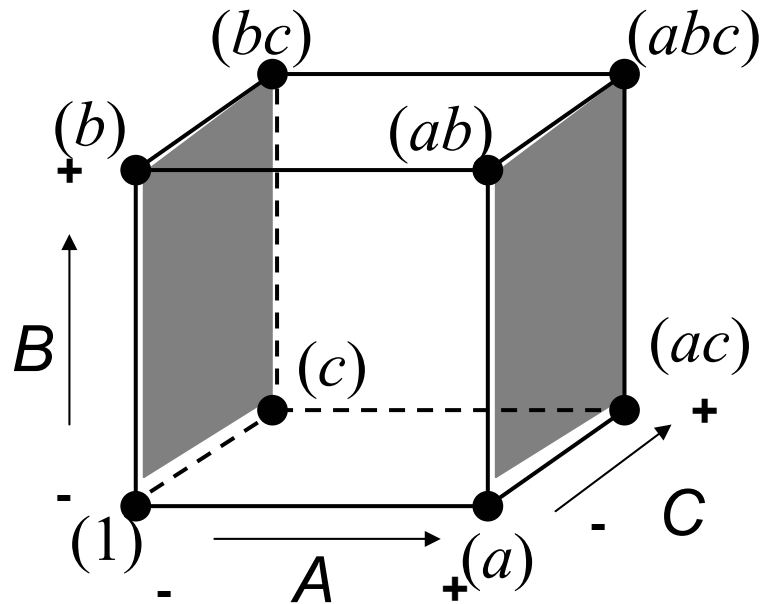

$$A \equiv \frac{1}{4} [(abc) + (ab) + (ac) + (a) - (b) - (c) - (bc) - (1)]$$

# Concept Test

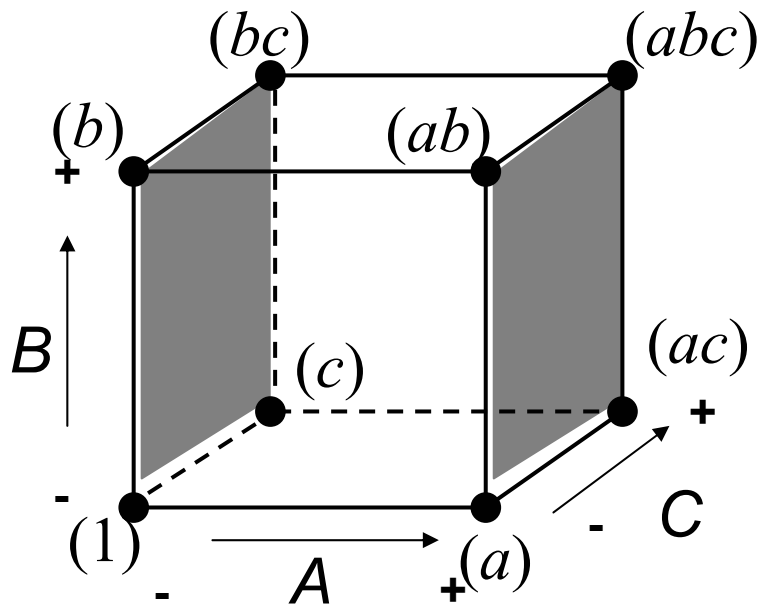

If the standard deviation of  $(a)$ ,  $(ab)$ , et cetera is  $\sigma$ , what is the standard deviation of the main effect estimate  $A$ ?

$$A \equiv \frac{1}{4} [(abc) + (ab) + (ac) + (a) - (b) - (c) - (bc) - (1)]$$

- 1)  $\sigma$       2) Less than  $\sigma$       3) More than  $\sigma$       4) Not enough info

# Efficiency

- The standard deviation for OFAT was  $\sqrt{2}\sigma$  using 4 experiments
- The standard deviation for FF was  $\frac{1}{4}\sqrt{8}\sigma = \frac{1}{2}\sqrt{2}\sigma$  using 8 experiments
- The inverse ratio of variance per unit is considered a measure of *relative efficiency*

$$\frac{\left[\sqrt{2}\sigma\right]^2}{4} \bigg/ \frac{\left[\frac{1}{2}\sqrt{2}\sigma\right]^2}{8}$$

- The FF is considered 2 times more efficient than the OFAT

# Factor Effect Plots

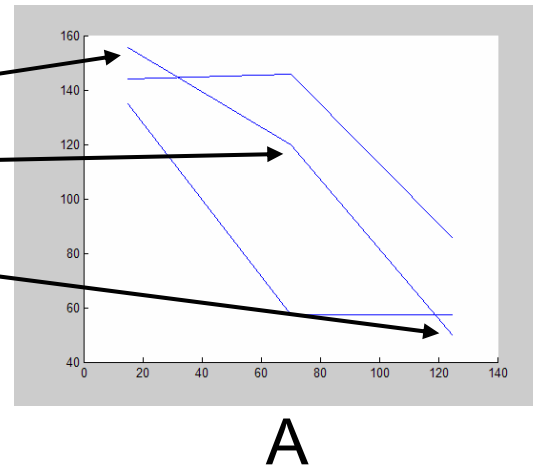
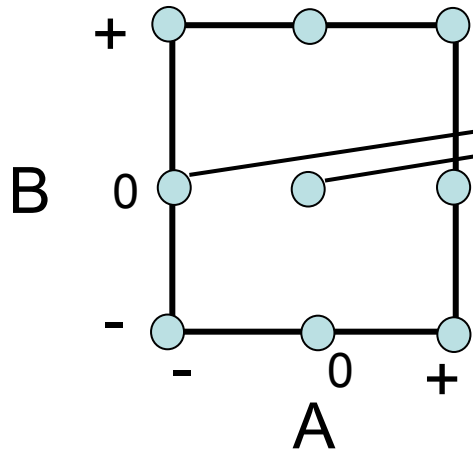
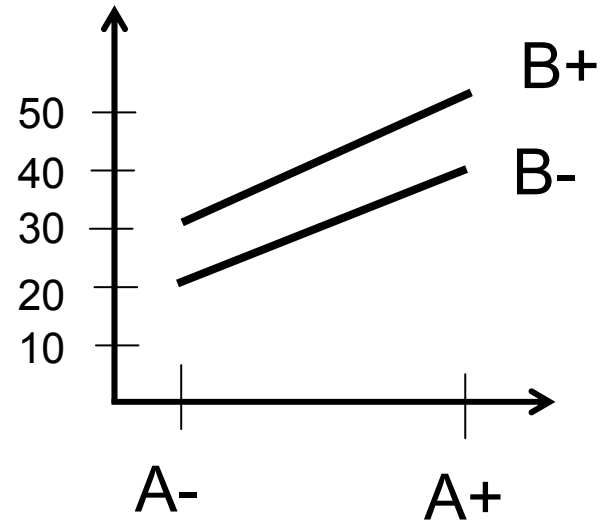
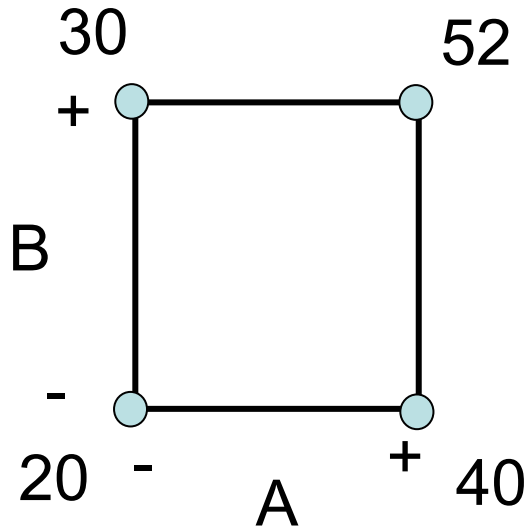

# Concept Test

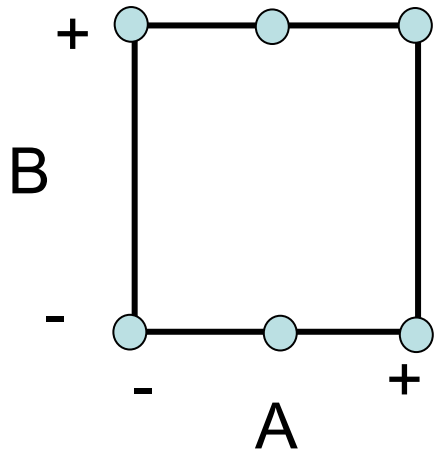

If there are no interactions in this system, then the factor effect plot from this design could look like:

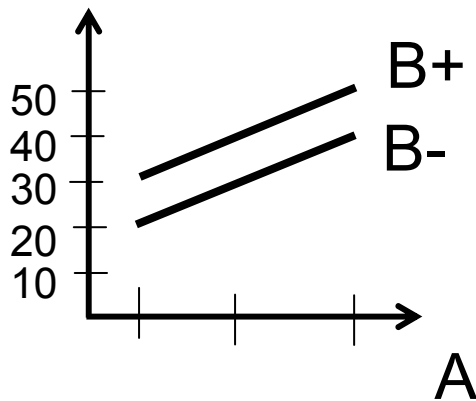

1

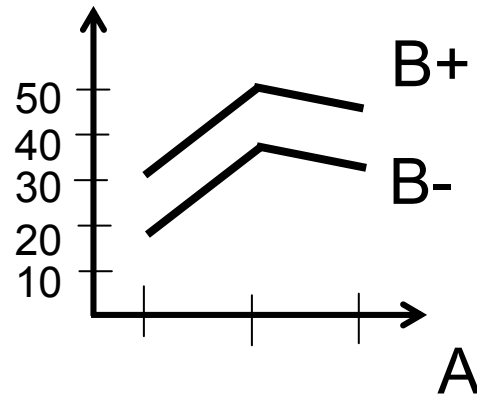

2

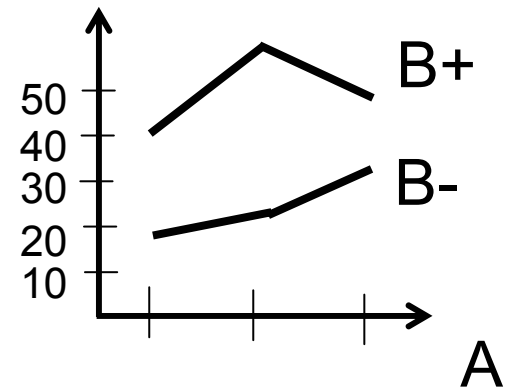

3

Hold up all cards that apply.

# Estimation of the Parameters $\beta$

Assume the model equation

$$\mathbf{y} = \mathbf{X}\boldsymbol{\beta} + \boldsymbol{\varepsilon}$$

We wish to minimize the sum squared error

$$L = \boldsymbol{\varepsilon}^T \boldsymbol{\varepsilon} = (\mathbf{y} - \mathbf{X}\boldsymbol{\beta})^T (\mathbf{y} - \mathbf{X}\boldsymbol{\beta})$$

To minimize, we take the derivative and set it equal to zero

$$\left. \frac{\partial L}{\partial \boldsymbol{\beta}} \right|_{\hat{\boldsymbol{\beta}}} = -2\mathbf{X}^T \mathbf{y} + 2\mathbf{X}^T \mathbf{X} \hat{\boldsymbol{\beta}}$$

The solution is

$$\hat{\boldsymbol{\beta}} = (\mathbf{X}^T \mathbf{X})^{-1} \mathbf{X}^T \mathbf{y}$$

And we define the fitted model

$$\hat{\mathbf{y}} = \mathbf{X} \hat{\boldsymbol{\beta}}$$



# Estimation of the Parameters $\beta$ when $\mathbf{X}$ is a $2^k$ design

$$\hat{\beta} = (\mathbf{X}^T \mathbf{X})^{-1} \mathbf{X}^T \mathbf{y}$$

$(\mathbf{X}^T \mathbf{X})_{ij} = 0$  if  $i \neq j$     The columns are orthogonal

$$(\mathbf{X}^T \mathbf{X})_{ij} = n2^k \text{ if } i = j$$

$$(\mathbf{X}^T \mathbf{X})^{-1} = \frac{1}{n2^k} \mathbf{I}$$

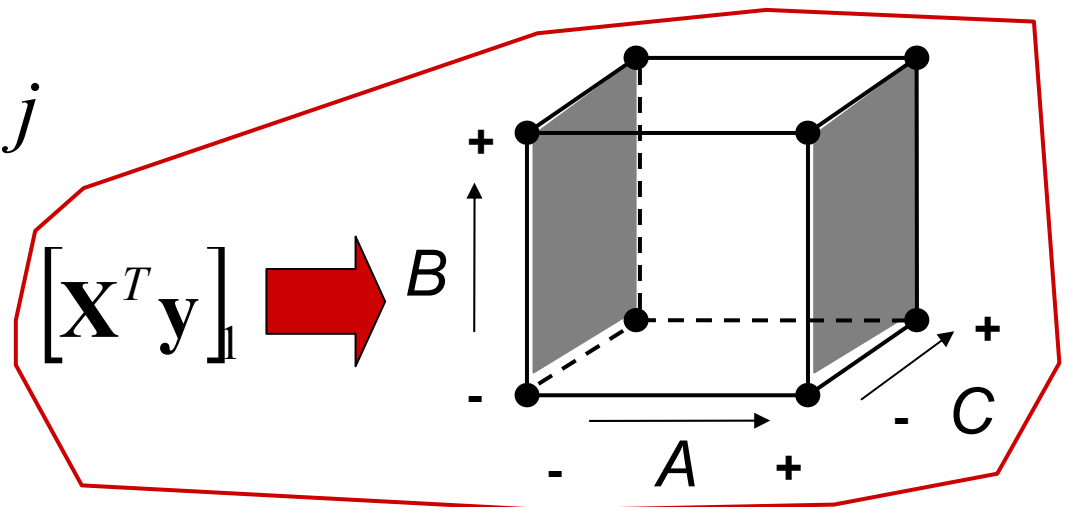

# Breakdown of Sum Squares

“Grand Total  
Sum of Squares”

$$\sum_{i=1}^a \sum_{j=1}^b \sum_{k=1}^n y_{ijk}^2$$

“Total Sum of  
Squares”

$$SS \text{ due to mean} \\ = N\bar{y}_{...}^2$$

$$SS_T = \sum_{i=1}^a \sum_{j=1}^b \sum_{k=1}^n (y_{ijk} - \bar{y}_{...})^2$$

$$SS_E$$

$$SS_A = bn \sum_{i=1}^a (\bar{y}_{i..} - \bar{y}_{...})^2$$

$$SS_{AB} = n \sum_{i=1}^a \sum_{j=1}^b (\bar{y}_{ij.} - \bar{y}_{i..} - \bar{y}_{.j.} - \bar{y}_{...})^2$$

$$SS_B = an \sum_{j=1}^b (\bar{y}_{.j.} - \bar{y}_{...})^2$$

# Breakdown of DOF

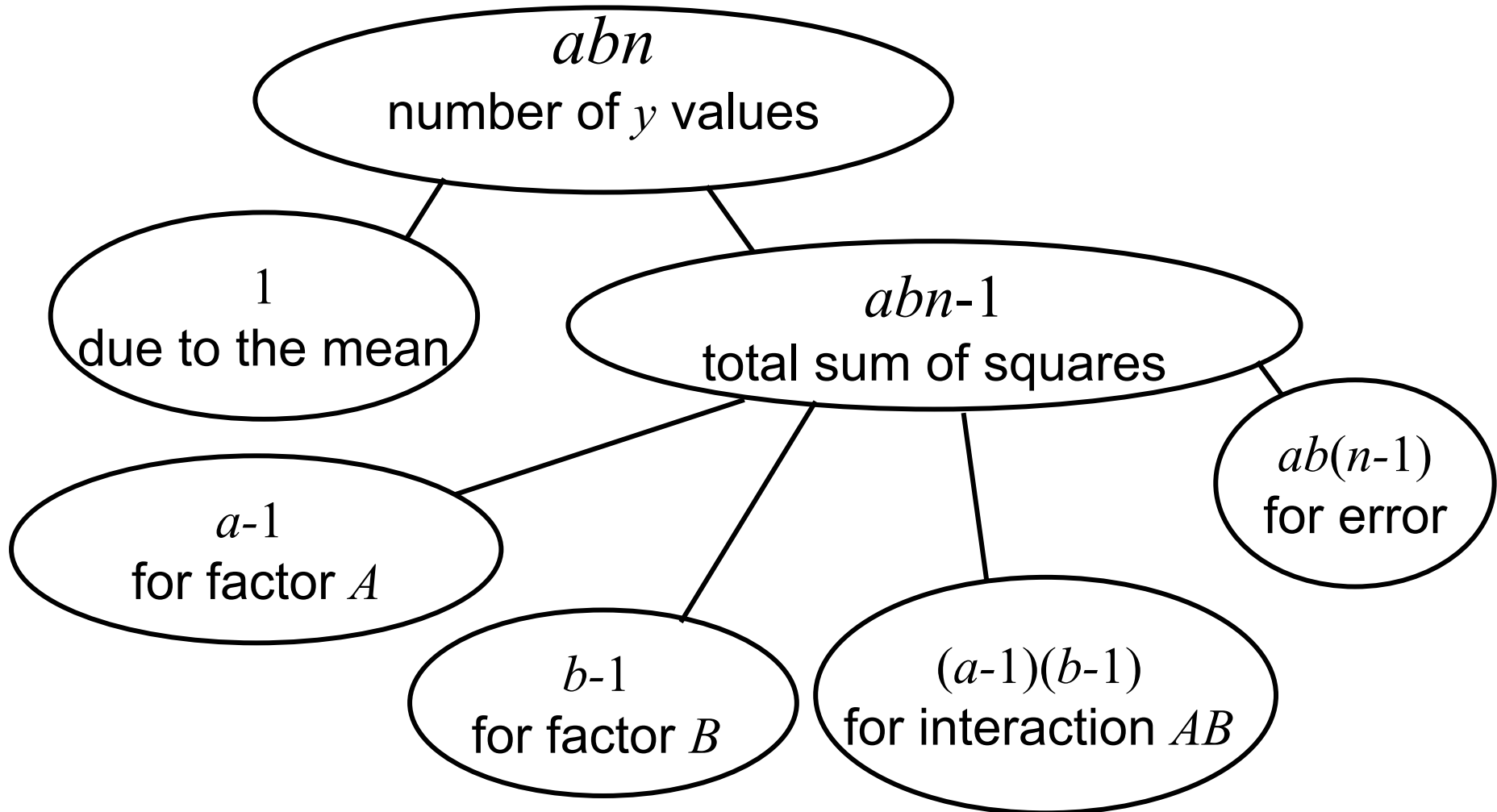

# Hypothesis Tests in Factorial Exp

- Hypotheses

$H_0$  : The factor has no effect at any of its levels

$H_1$  : The factor has an effect for at least one of its levels

- Test statistic

$$F_0 = \frac{MS_A}{MS_E}$$

- Criterion for rejecting  $H_0$   $F_0 > F_{\alpha, a-1, ab(n-1)}$

# Example 5-1 – Battery Life

```
FF= fullfact([3 3]);  
X=[FF; FF; FF; FF];  
Y=[130 150 138 34 136 174 20 25 96 155 188 110 40 122  
120 70 70 104 74 159 168 80 106 150 82 58 82 180 126 160  
75 115 139 58 45 60]';
```

```
[p,table,stats]=anovan(Y,{X(:,1),X(:,2)},'interaction');
```

```
hold off; hold on
```

```
for i=1:3; for j=1:3;
```

```
intplt(i,j)=(1/4)*sum(Y.*(X(:,1)==j).*(X(:,2)==i)); end
```

```
plot([15 70 125],intplt(:,i)); end
```

Source	Sum Sq.	d. f.	Mean Sq.	F	Prob>F
X1	10683.7	2	5341.9	7.91	0.002
X2	39118.7	2	19559.4	28.97	0
X1*X2	9613.8	4	2403.4	3.56	0.0186
Error	18230.7	27	675.2		
Total	77647	35			

Constrained (Type III) sums of squares.

ANOVA table



Interaction plot

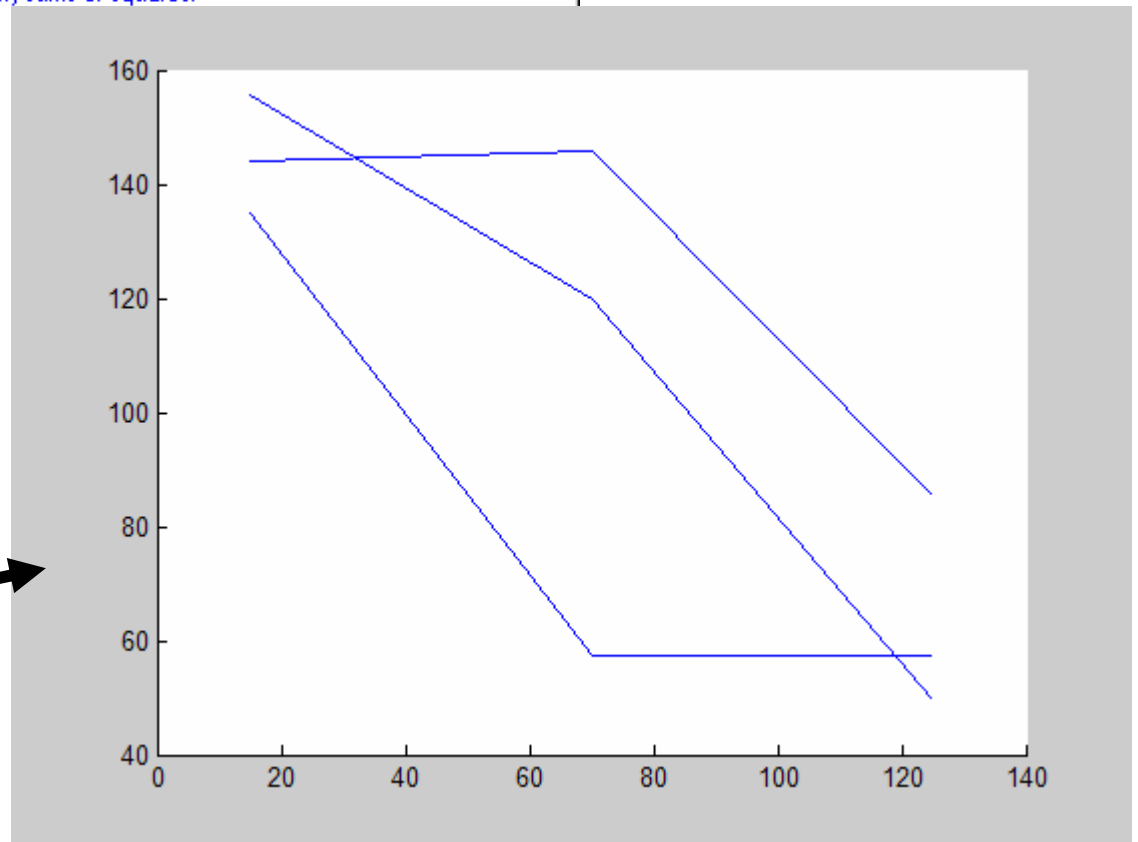

# Geometric Growth of Experimental Effort

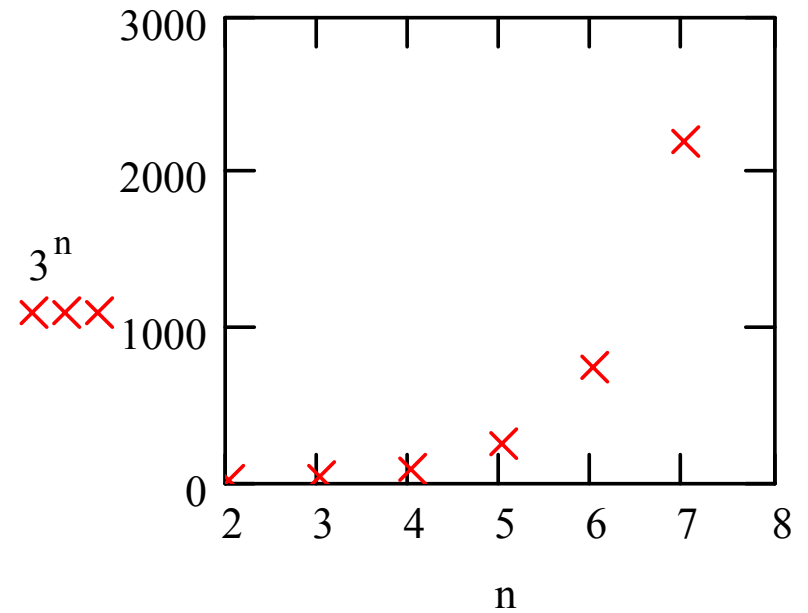
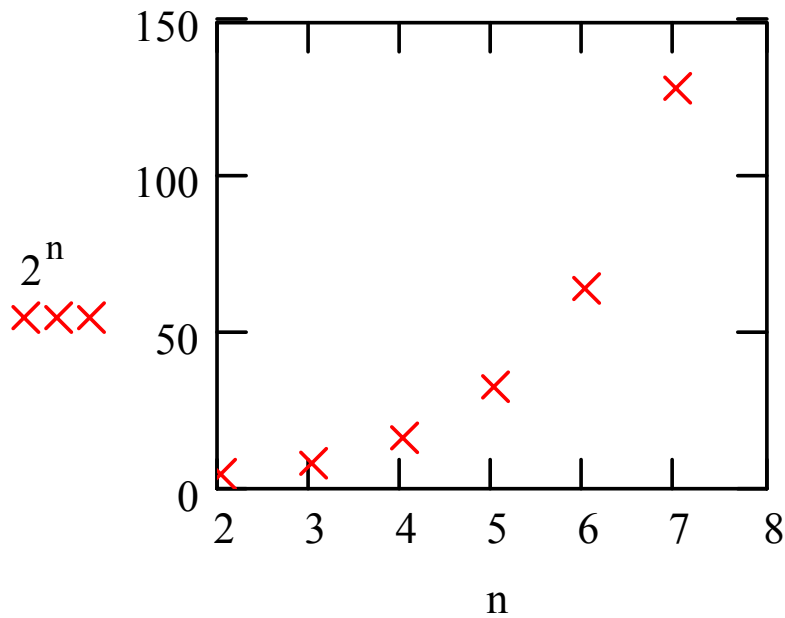

# Fractional Factorial Experiments

## Cuboidal Representation

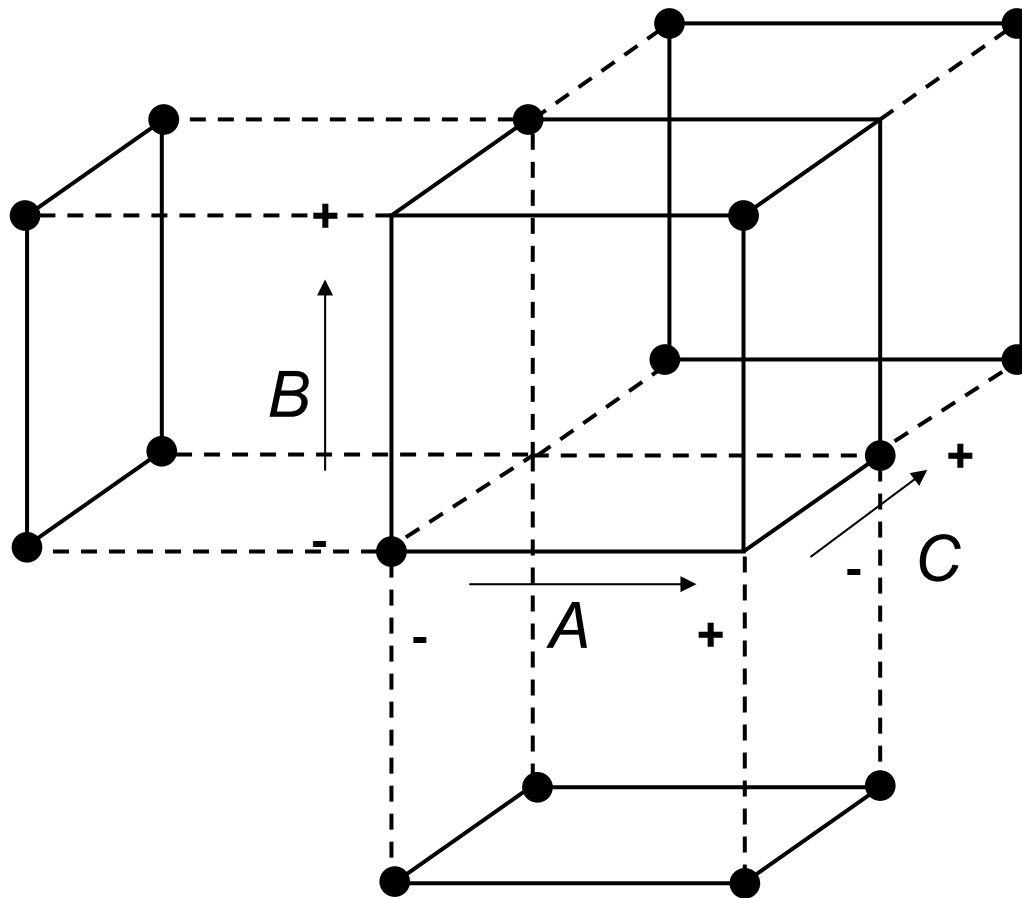

This is the  $2^{3-1}$  fractional factorial.



# Fractional Factorial Experiments

## Two Levels

<b>Trial</b>	<b>A</b>	<b>B</b>	<b>C</b>	<b>D</b>	<b>E</b>	<b>F</b>	<b>G</b>	<b>FG=-A</b>
<b>1</b>	-1	-1	-1	-1	-1	-1	-1	+1
<b>2</b>	-1	-1	-1	+1	+1	+1	+1	+1
<b>3</b>	-1	+1	+1	-1	-1	+1	+1	+1
<b>4</b>	-1	+1	+1	+1	+1	-1	-1	+1
<b>5</b>	+1	-1	+1	-1	+1	-1	+1	-1
<b>6</b>	+1	-1	+1	+1	-1	+1	-1	-1
<b>7</b>	+1	+1	-1	-1	+1	+1	-1	-1
<b>8</b>	+1	+1	-1	+1	-1	-1	+1	-1

$2^{7-4}$  Design (aka “orthogonal array”)

Every factor is at each level an equal number of times (balance).

High replication numbers provide precision in effect estimation.

Resolution III.

# Fractional Factorial Experiments

## Two Levels

The design below is also fractional factorial design.

Plackett Burman (P-B)<sub>3,9</sub>

Taguchi OA<sub>9</sub>(3<sup>4</sup>)

Control Factors			
A	B	C	D
1	1	1	1
1	2	2	2
1	3	3	3
2	1	2	3
2	2	3	1
2	3	1	2
3	1	3	2
3	2	1	3
3	3	2	1

requires only  
 $k(p-1)+1=9$   
experiments

But it is only Resolution III  
and also has complex  
confounding patterns.

# Sparsity of Effects

- An experimenter may list several factors
- They usually affect the response to greatly varying degrees
- The drop off is surprisingly steep ( $\sim 1/n^2$ )
- Not sparse if prior knowledge is used or if factors are screened

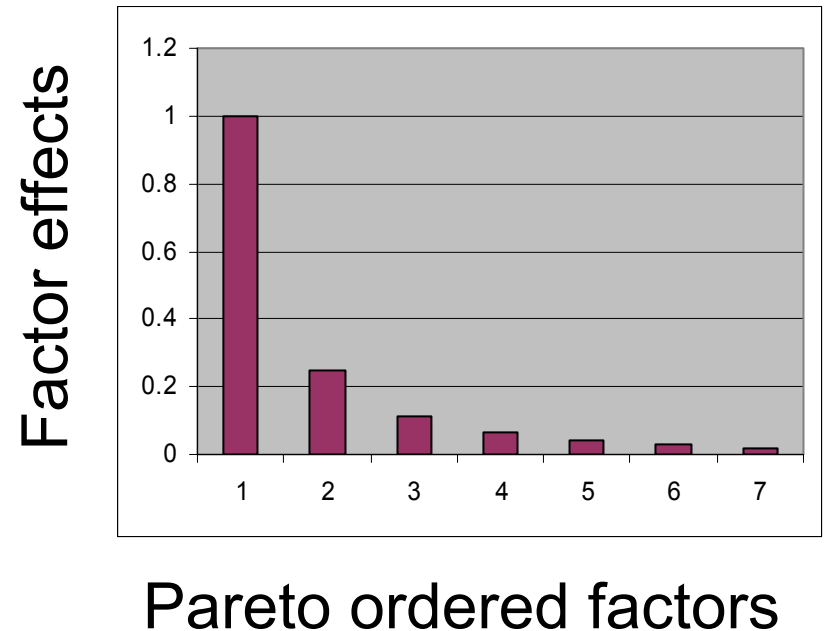

# Resolution

- **III** Main effects are clear of other main effects but aliased with two-factor interactions
- **IV** Main effects are clear of other main effects and clear of two-factor interactions but main effects are aliased with three-factor interactions and two-factor interactions are aliased with other two-factor interactions
- **V** Two-factor interactions are clear of other two-factor interactions but are aliased with three factor interactions...

# Hierarchy

- Main effects are usually more important than two-factor interactions
- Two-way interactions are usually more important than three-factor interactions
- And so on
- Taylor's series seems to support the idea



$$\sum_{n=0}^{\infty} (x-a)^n \frac{f^{(n)}(a)}{n!}$$

Do you know of some important interaction effects?

# Inheritance

- Two-factor interactions are **most** likely when both participating factors (parents?) are strong
- Two-way interactions are **least** likely when neither parent is strong
- And so on

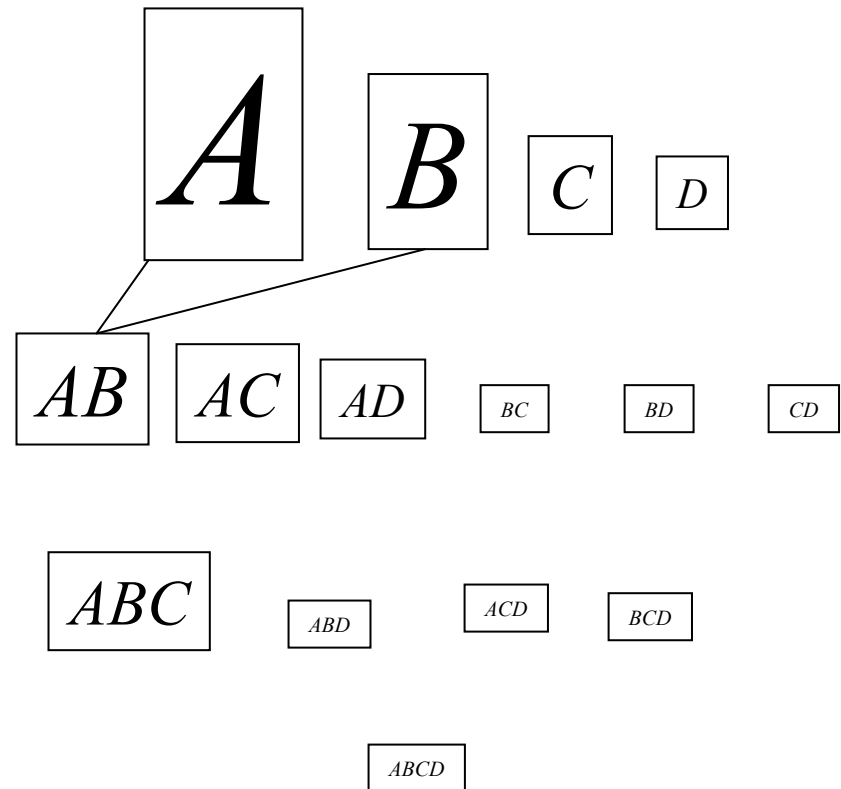

# Important Concepts in DOE

- **Efficiency** – ability of an experiment to estimate effects with small error variance
- **Resolution** – the ability of an experiment to provide estimates of effects that are clear of other effects
- **Sparsity of Effects** – factor effects are few
- **Hierarchy** – interactions are generally less significant than main effects
- **Inheritance** – if an interaction is significant, at least one of its “parents” is usually significant

# Plan for the Session

- Thomke -- Enlightened Experimentation
- Statistical Preliminaries
- Design of Experiments
  - Fundamentals
  - ➡ Box – Statistics as a Catalyst
    - Frey – A role for one factor at a time?
- Next steps



# Response Surface Methodology

- A method to seek improvements in a system by sequential investigation and parameter design
  - Variable screening
  - Steepest ascent
  - Fitting polynomial models
  - Empirical optimization

# Statistics as a Catalyst to Learning

## Part I – An example

- Concerned improvement of a paper helicopter
- Screening experiment  $2_{IV}^{8-4}$
- Steepest ascent
- Full factorial  $2^4$
- Sequentially assembled CCD
- Resulted in a 2X increase in flight time vs the starting point design
- $(16+16+30)*4 = 248$  experiments

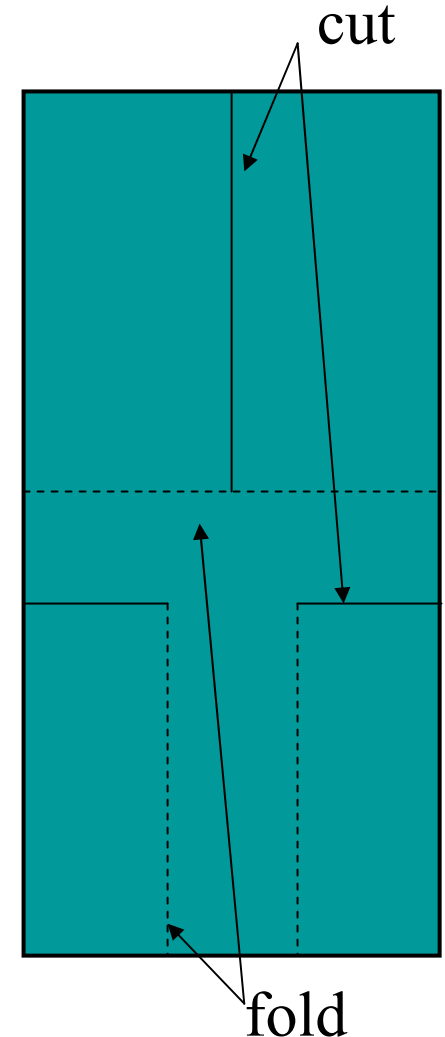

# Central Composite Design

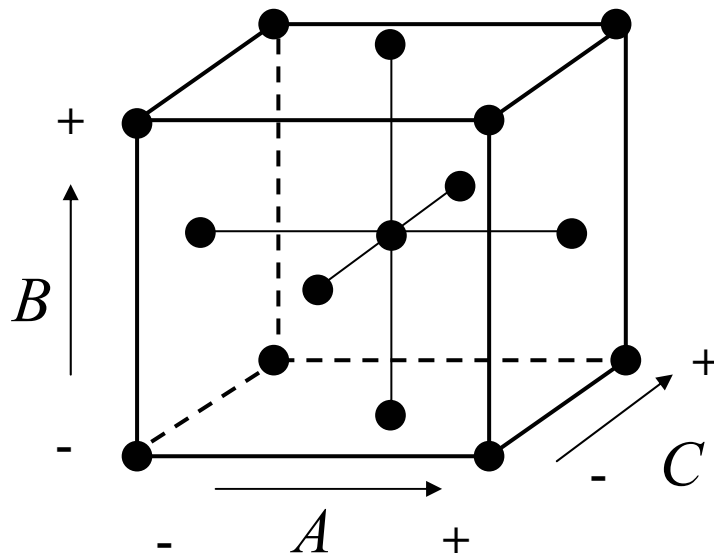

$2^3$  with center points  
and axial runs

# The Iterative Learning Process

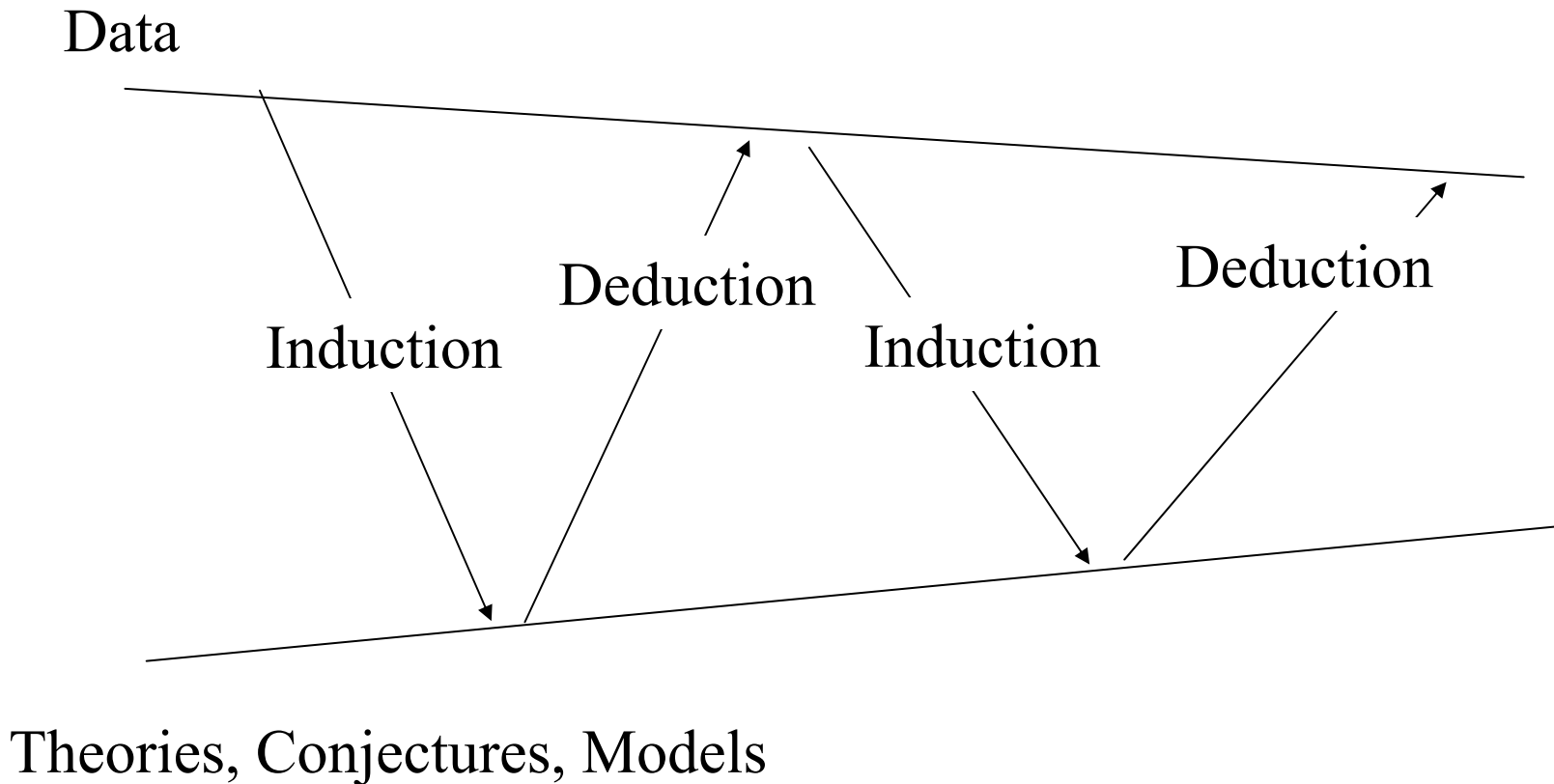

# Controlled Convergence

- This is Pugh's vision of the conceptual phase of design
- Takes us from a specification to a concept
- Convergent and divergent thinking equally important

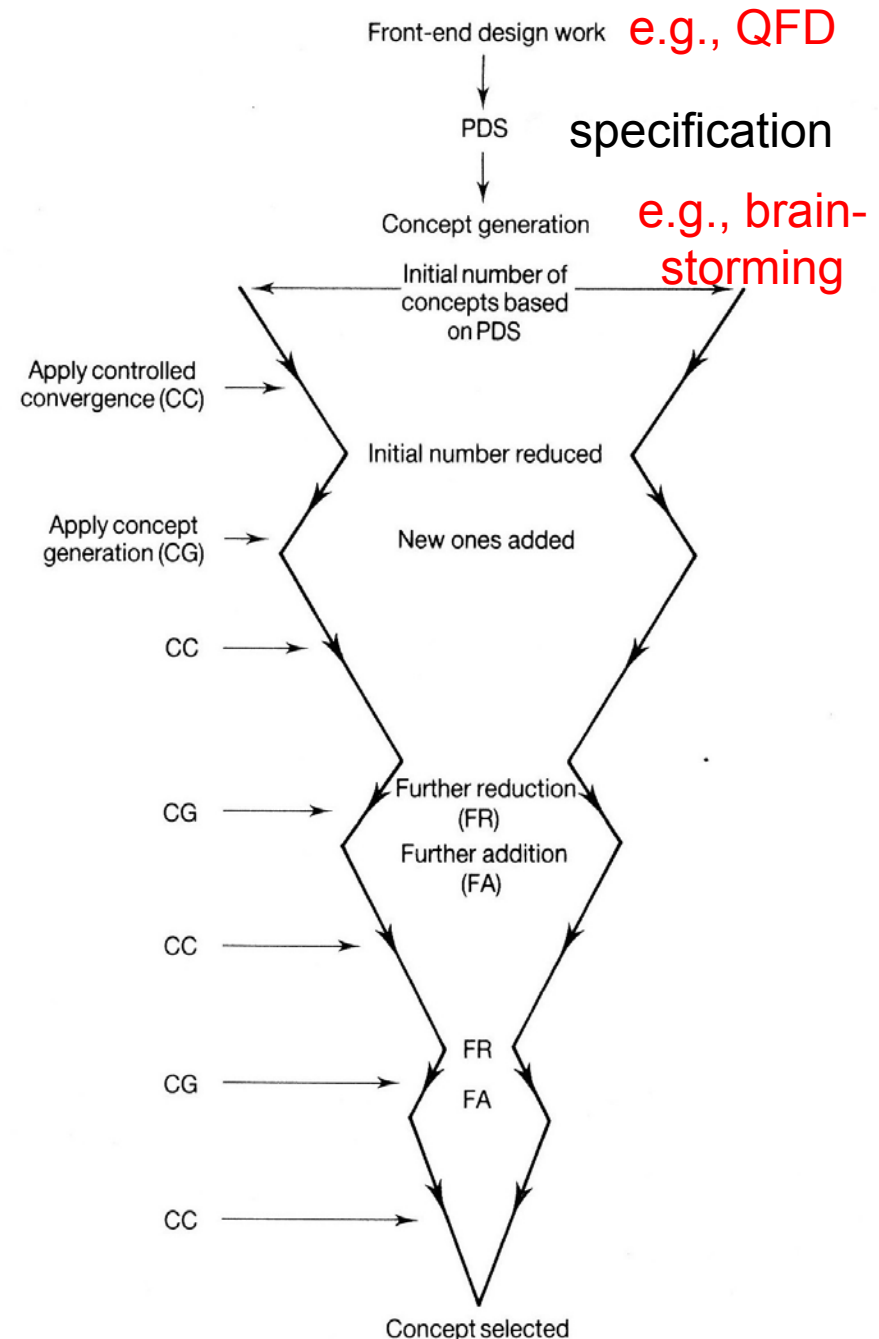

# Design of Experiments in the 20<sup>th</sup> Century

- 1926 – R. A. Fisher, factorial design
- 1947 – C. R. Rao, fractional factorial design
- 1951 – Box and Wilson, response surface methodology
- 1959 – Kiefer and Wolfowitz, optimal design theory

# George Box on Sequential Experimentation

“Because results are usually known quickly, the natural way to experiment is to use information from each **group of runs** to plan the next ...”

“...Statistical training unduly emphasizes mathematics at the expense of science. This has resulted in **undue emphasis on “one-shot” statistical procedures**... examples are hypothesis testing and alphabetically optimal designs.”

# Statistics as a Catalyst to Learning

## Major Points for SE

- SE requires efficient experimentation
- SE should involve alternation between induction and deduction (which is done by humans)
- SE practitioners and researchers should be skeptical of mathematical or axiomatic bases for SE
- SE practitioners and researchers should maintain a grounding in reality, data, experiments



# Plan for the Session

- Thomke -- Enlightened Experimentation
- Statistical Preliminaries
- Design of Experiments
  - Fundamentals
  - Box – Statistics as a Catalyst
  - ➡ Frey – A role for one factor at a time?
- Next steps

*One way of thinking of the great advances of the science of experimentation in this century is as **the final demise of the “one factor at a time” method**, although it should be said that there are still organizations which have never heard of factorial experimentation and use up many man hours wandering a crooked path.*

– N. Logothetis and H. P. Wynn

“The factorial design is ideally suited for experiments whose purpose is to map a function in a pre-assigned range.”

“...however, the factorial design has certain deficiencies ... It devotes observations to exploring regions that may be of no interest.”

“...These deficiencies of the factorial design suggest that an efficient design for the present purpose ought to be sequential; that is, ought to **adjust the experimental program at each stage** in light of the results of prior stages.”

Friedman, Milton, and L. J. Savage, 1947, “Planning Experiments Seeking Maxima”, in *Techniques of Statistical Analysis*, pp. 365-372.

“Some scientists do their experimental work in single steps. They hope to learn something from each run ... they see and react to data more rapidly ...”

“...Such experiments are economical”

“...May give biased estimates”

“If he has in fact found out a good deal by his methods, it must be true that **the effects are at least three or four times his average random error per trial.**”

Cuthbert Daniel, 1973, “One-at-a-Time Plans”, *Journal of the American Statistical Association*, vol. 68, no. 342, pp. 353-360.

Ford Motor Company, “Module 18: Robust System Design Application,”  
FAO Reliability Guide, Tools and Methods Modules.

Step 4 Summary:

- Determine control factor levels
- Calculate the DOF
- Determine if there are any interactions
- **Select the appropriate orthogonal array**

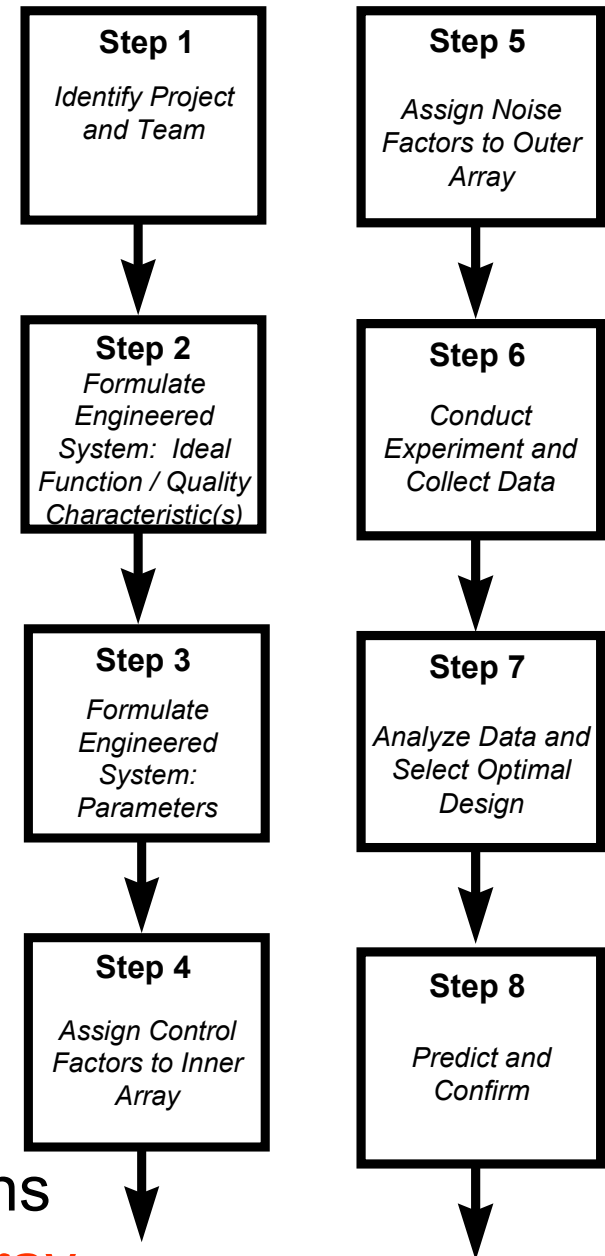

# One at a Time Strategy

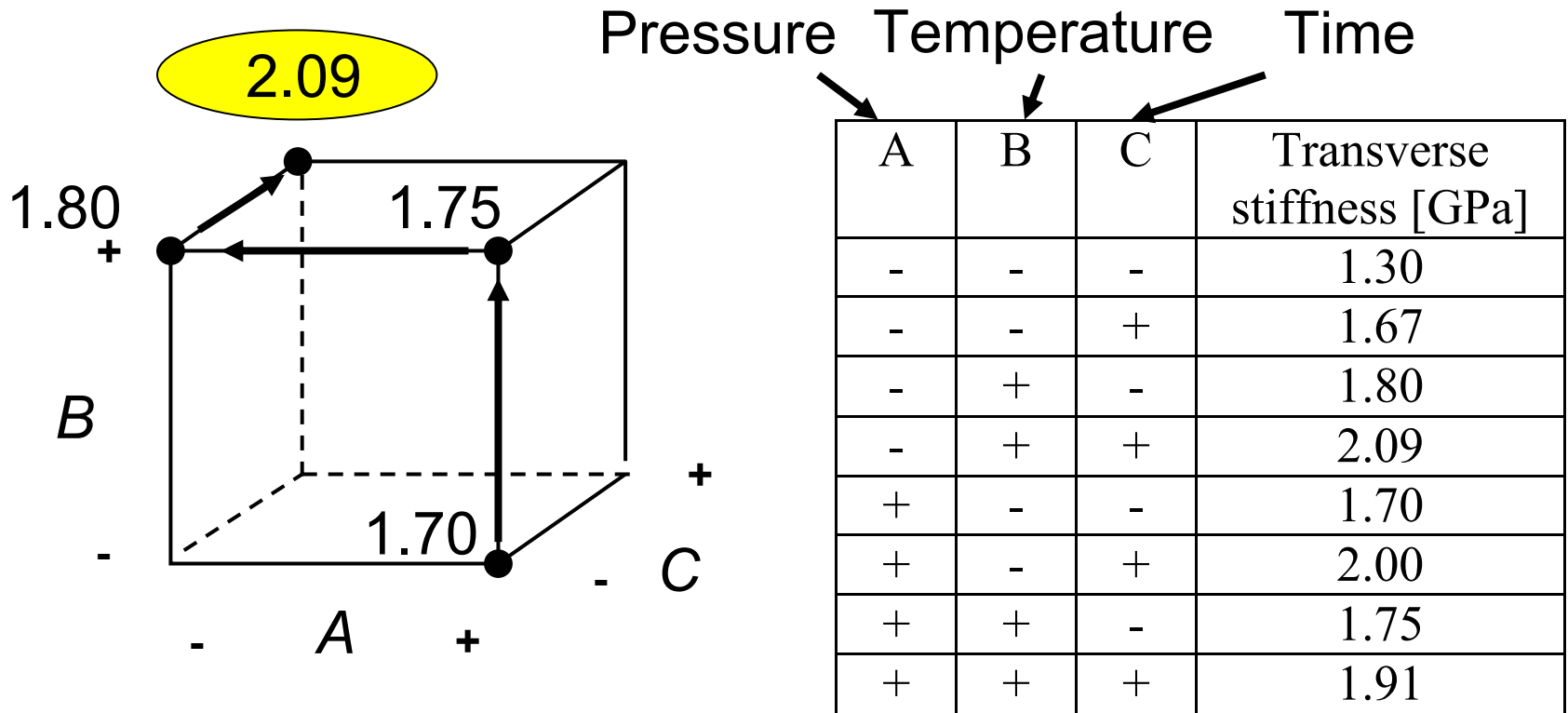

Bogoeva-Gaceva, G., E. Mader, and H. Queck (2000) Properties of glass fiber polypropylene composites produced from split-warp-knit textile preforms, *Journal of Thermoplastic Composite Materials* 13: 363-377.

# One at a Time Strategy

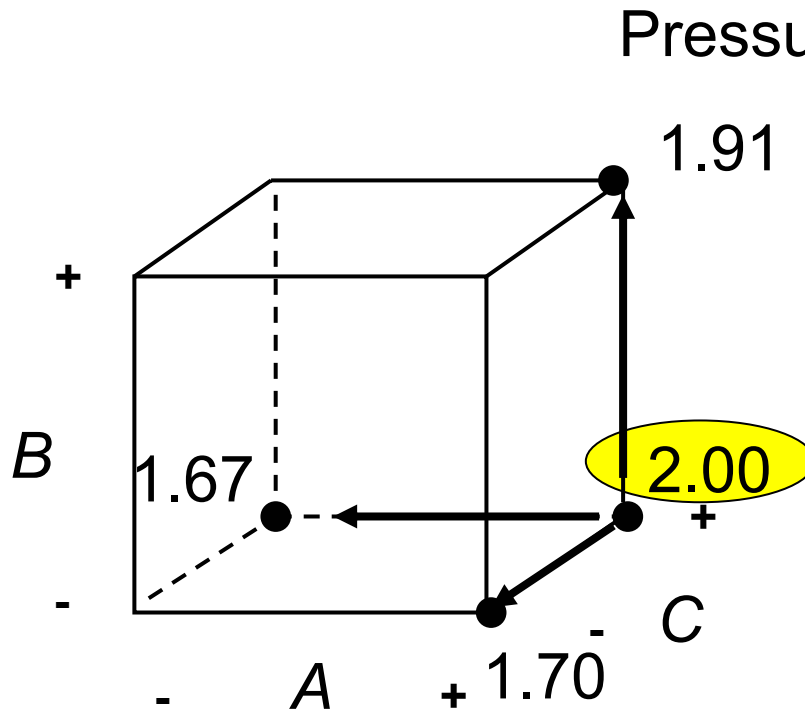

Pressure Temperature Time

A	B	C	Transverse stiffness [GPa]
-	-	-	1.30
-	-	+	1.67
-	+	-	1.80
-	+	+	2.09
+	-	-	1.70
+	-	+	2.00
+	+	-	1.75
+	+	+	1.91

# One at a Time Strategy

Starting point			Order in which factors were varied					
A	B	C	ABC	ACB	BAC	BCA	CAB	CBA
-	-	-	2.09	2.00	2.09	2.09	2.00	2.09
-	-	+	2.00	2.00	2.09	2.09	2.00	2.09
-	+	-	2.09	2.09	2.09	2.09	2.09	2.09
-	+	+	2.09	2.09	2.09	2.09	2.09	2.09
+	-	-	2.09	2.00	2.09	2.09	2.00	2.00
+	-	+	2.00	2.00	2.00	2.00	2.00	2.00
+	+	-	2.09	2.09	2.09	2.09	2.09	2.00
+	+	+	2.09	2.09	2.00	2.00	2.09	2.00

1/2 of the time -- the optimum level setting 2.09GPa.

1/2 of the time – a sub-optimum of 2.00GPa

Mean outcome is 2.04GPa.



# Main Effects and Interactions

Effect	Transverse stiffness [GPa]
$\mu$	1.778
A	0.063
B	0.110
C	0.140
AB	-0.120
AC	-0.025
BC	-0.027
ABC	-0.008

A	B	C	Transverse stiffness [GPa]
-	-	-	1.30
-	-	+	1.67
-	+	-	1.80
-	+	+	2.09
+	-	-	1.70
+	-	+	2.00
+	+	-	1.75
+	+	+	1.91

The approach always *exploited* the two largest effects including an interaction although the experiment cannot *resolve* interactions

# Fractional Factorial

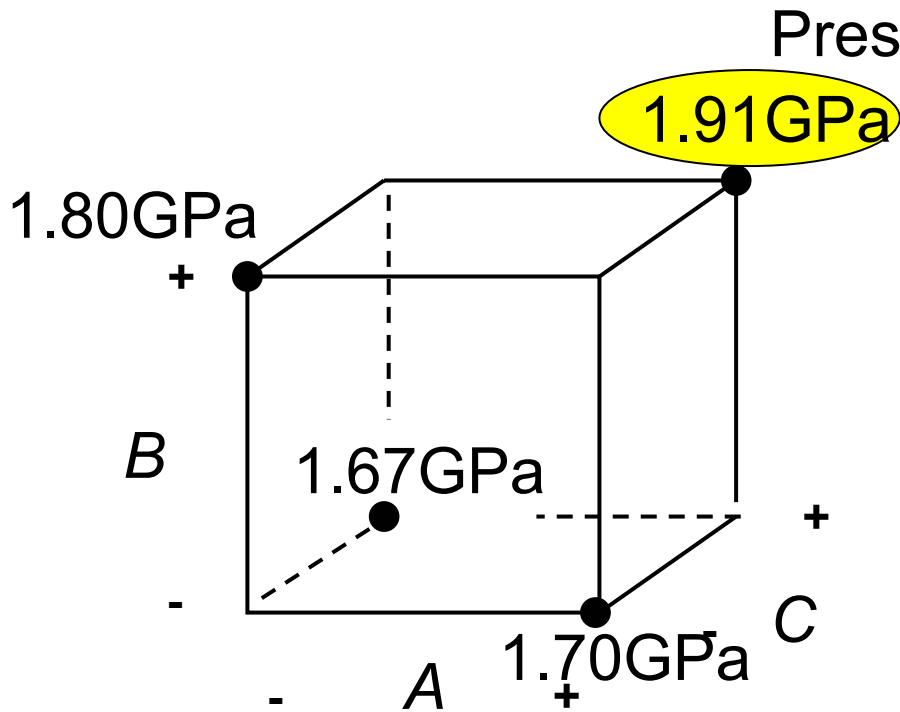

A	B	C	Transverse stiffness [GPa]
-	-	-	1.30
-	-	+	1.67
-	+	-	1.80
-	+	+	2.09
+	-	-	1.70
+	-	+	2.00
+	+	-	1.75
+	+	+	1.91

# Main Effects and Interactions

Effect	Transverse stiffness [GPa]
$\mu$	1.778
A	0.063
B	0.110
C	0.140
AB	-0.120
AC	-0.025
BC	-0.027
ABC	-0.008

Factorial design correctly estimates main effects BUT

← AB interaction is larger than main effects of factor A or B and is anti-synergistic

Factorial design worked as advertised but missed the optimum

# Effect of Experimental Error

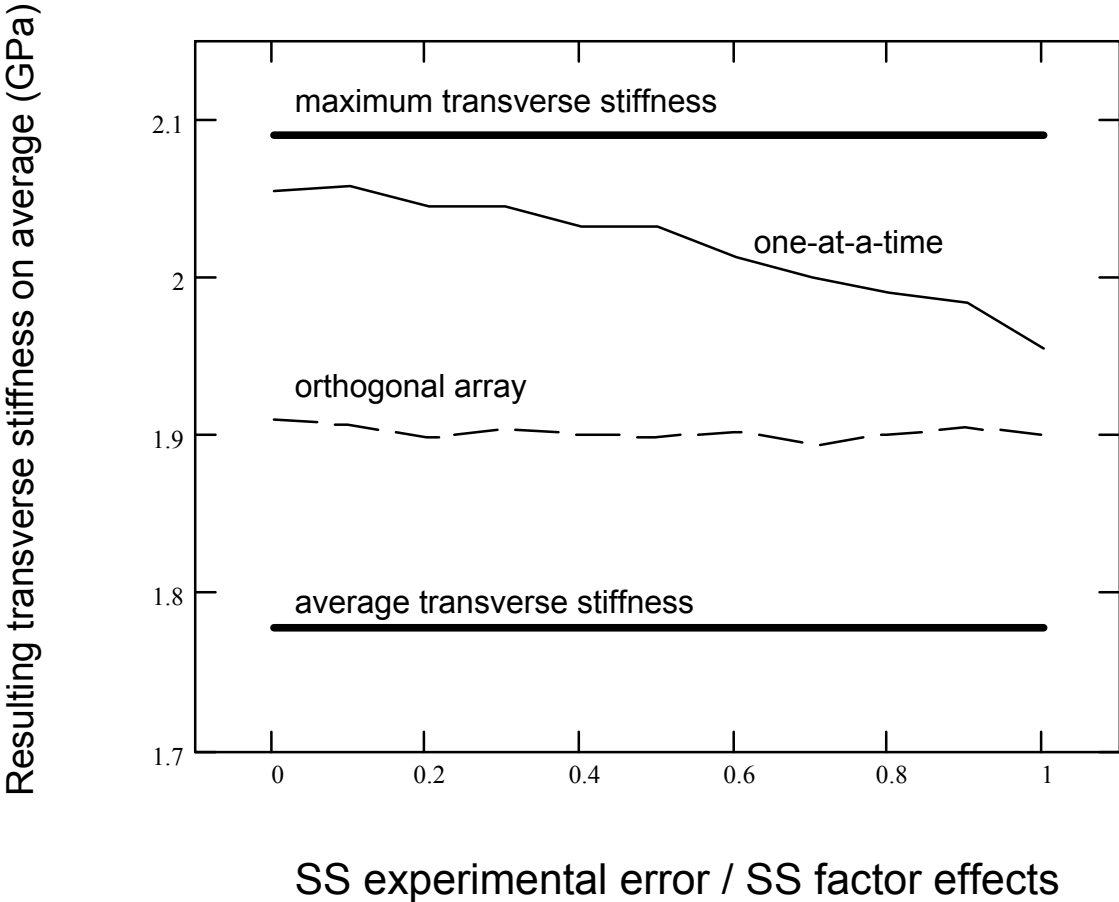

# Results from a Meta-Study

- 66 responses from journals and textbooks
- Classified according to interaction strength

		Strength of Experimental Error										
		0	0.1	0.2	0.3	0.4	0.5	0.6	0.7	0.8	0.9	1
Interaction Strength	Mild	100/99	99/98	98/98	96/96	94/94	89/92	86/88	81/86	77/82	73/79	69/75
	Moderate	96/90	95/90	93/89	90/88	86/86	83/84	80/81	76/81	72/77	69/74	64/70
	Strong	86/67	85/64	82/62	79/63	77/63	72/64	71/63	67/61	64/58	62/55	56/50
	Dominant	80/39	79/36	77/34	75/37	72/37	70/35	69/35	64/34	63/31	61/35	59/35

OAT/OA



% of possible improvement with the indicated approach

# Conclusions

- Factorial design of experiments may not be best for all engineering scenarios
- Adaptive one-factor-at-a-time may provide more improvement
  - When you must use very few experiments AND
  - EITHER Interactions are >25% of factorial effects OR
  - Pure experimental error is 40% or less of factorial effects
- One-at-a-time designs exploit some interactions (on average) even though it can't resolve them
- There may be human factors to consider too

# Plan for the Session

- Thomke -- Enlightened Experimentation
- Statistical Preliminaries
- Design of Experiments
  - Fundamentals
  - Box – Statistics as a Catalyst
  - Frey – A role for one factor at a time?

 Next steps

# Next Steps

- You can download HW #5 Error Budgetting
  - Due 8:30AM Tues 13 July
- See you at Thursday's session
  - On the topic "Design of Experiments"
  - 8:30AM Thursday, 8 July
- Reading assignment for Thursday
  - All of Thomke
  - Skim Box
  - Skim Frey