



Adaptive Reconnaissance Golay-3 Optical Satellite (ARGOS)



Prof David W. Miller



ARGOS Overview

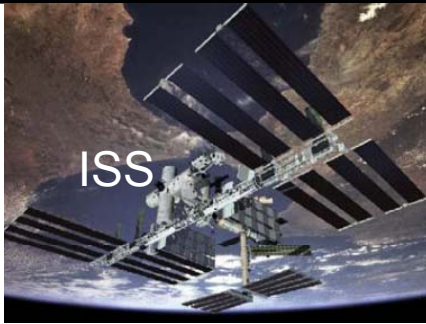

Angular Resolution at $\lambda=550$ nm:	0.35 arcsec
Wavelength Regime:	400-700 nm FOR
(Field-of-Regard):	120° (full cone)
FOV (Field-of-View)-min:	3 x 3 arcmin
SNR	100 (Min)
Pointing Accuracy:	+/- 10 arcsec
Autonomous Operation:	> 1 hour

Goal :
Demonstrate the feasibility of Interferometry technology

First field operation in May

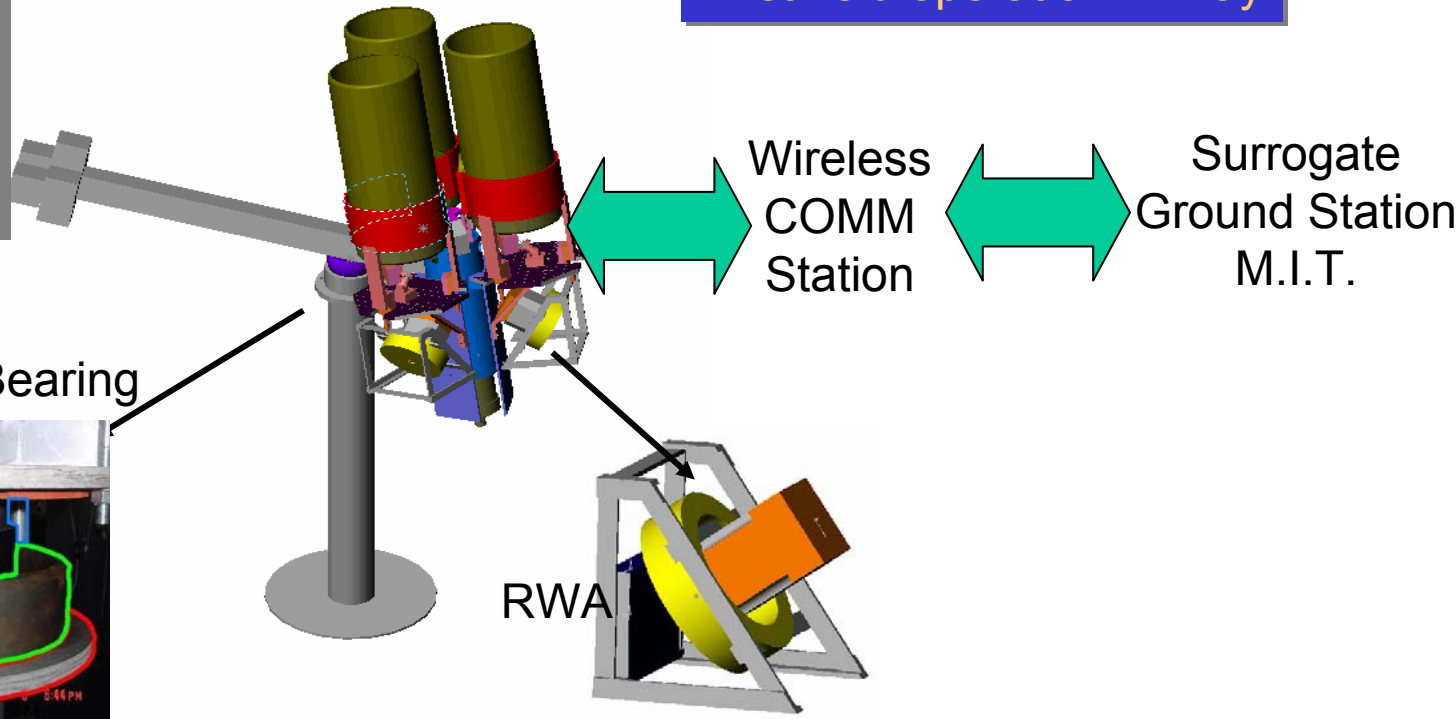



Full Structure

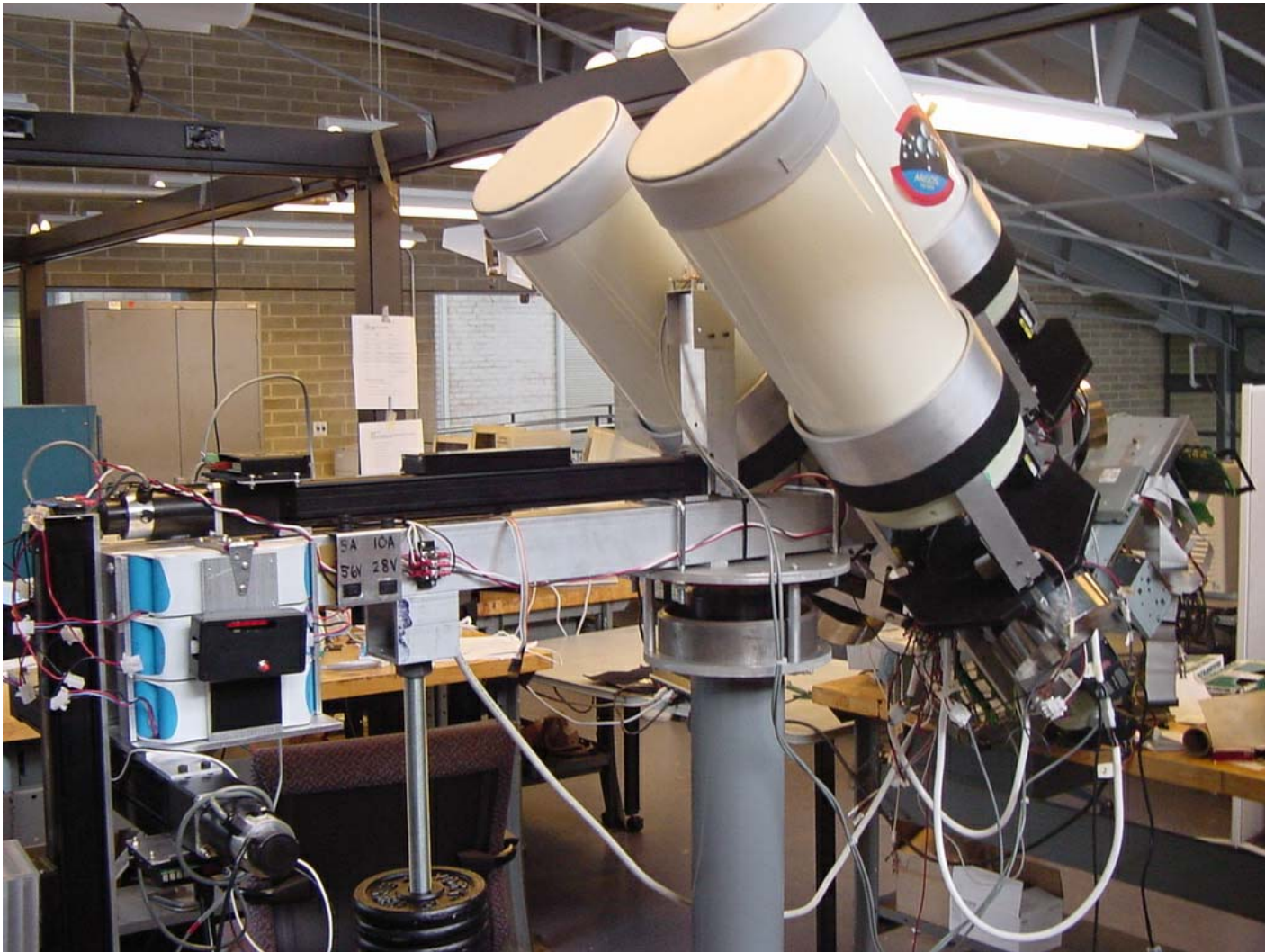



Sub-Aperture Manufacturing

TAKAHASHI 8-inch High Precision (RMS WF errors $1/20 \lambda$) Telescope

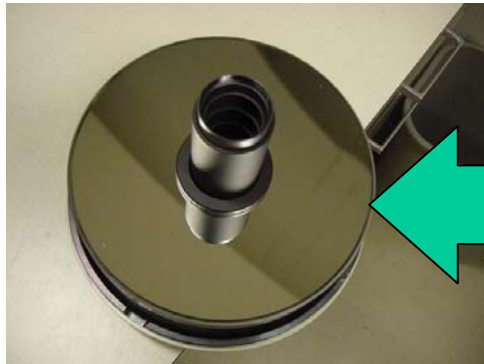

Designed optimized achromatic doublet to convert a focal telescope to afocal with Magnification $m=10$



Final Design

•FK51/BaK2

- Δ CTE 5.3
- 0.0027 RMS Error
- Some sensitivity to thermal shock
- Manufacturable tolerances



Relay Optics Design

1. Sub Aperture
2. Collimator
3. FSM+ODL
4. Pyramidal Mirror
5. Beam Combiner
6. CCD

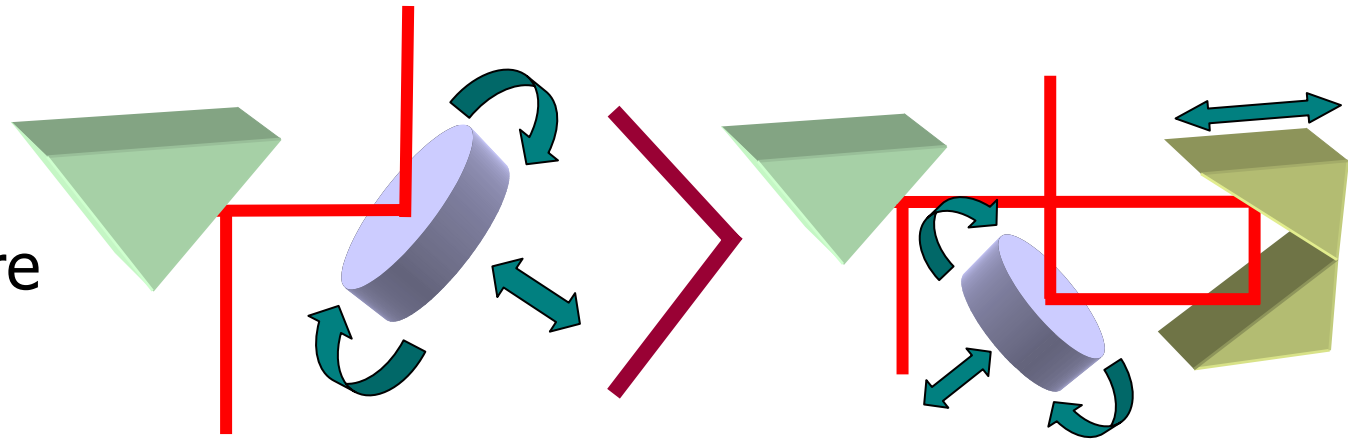

The Advantages of Two Mirror Design
the cost, the controller complexity,
less reflectance loss, smaller possible misalignment
errors, compactness

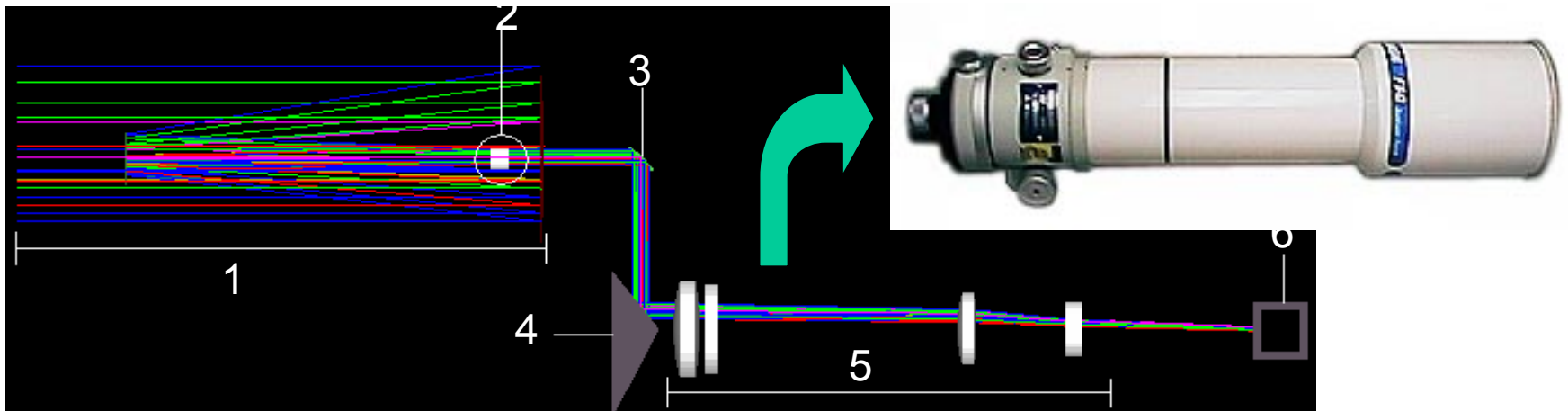



Allowable Structural Misalignments

$$45-A+B = 45-B$$

$$2B=A$$

Magnification $m=10$

$B = 0.5 * A * 10 = 5 A$. In reality, a factor of 6.4 works well up to 0.01 degree

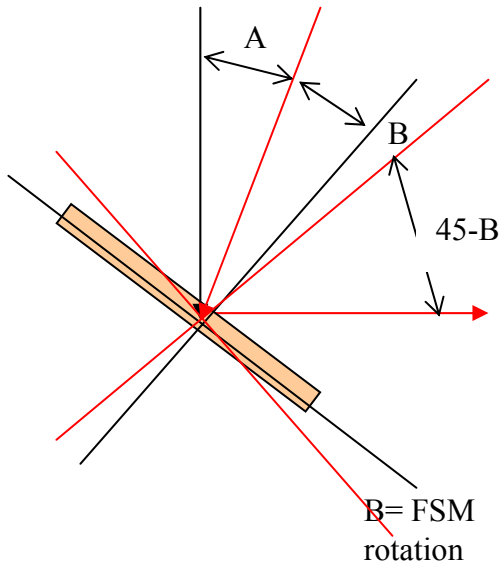

Telescope Tilt [Deg]	FSM Comp [arcsec]	FSM OPD [Deg] Max	FSM OPD [mm]	Strehl Ratio Aberrated	SR restored
0.0001	0.36	0.034 degree -0.00064	0	0.687	0.982
0.001	3.6	-0.0064	0	0.016	0.979
0.005	18	-0.032	0	0.192	0.907
0.01	36	-0.064	0	0.064	0.604
0.01	36	-0.064	0.0002	0.189	0.859

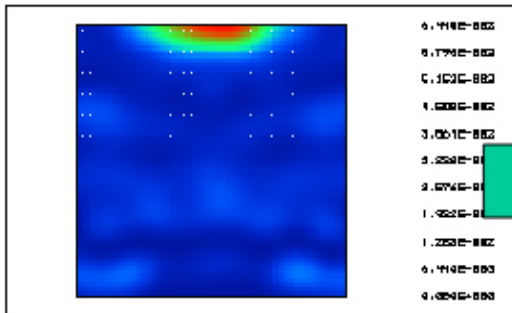

0.01 degree tilt

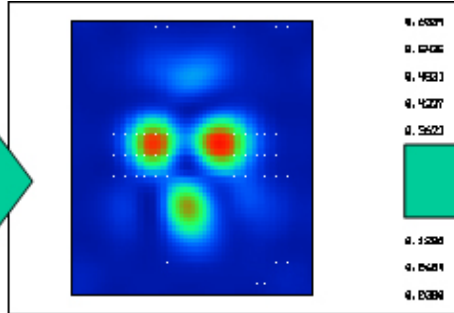

FSM Correction

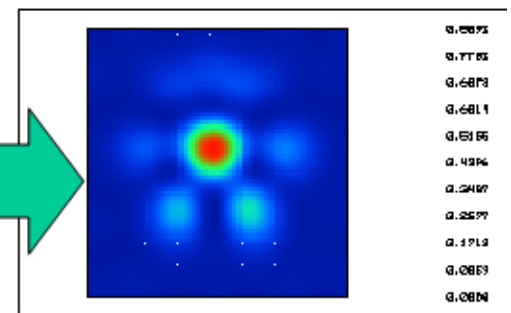

OPD Correction



Passive/Active Actuators



7° Mount 14 μrad

600 μrad^{FSM} 0.05 μrad



FSM MOUNT

- Angular Range +/- 7°
- Angular Res. +/- 0.0008° (14 μrad)
- Linear Range 1 cm
- Linear Res. 1 μm

FSM+ODL

- Angular Range +/- 600 μrad
- Angular Res. +/- 0.05 μrad
- Linear Range 12 μm
- Linear Res. 0.2 nm

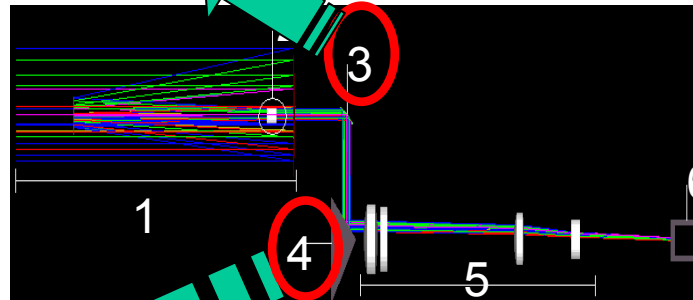

Pyramidal Mirror



Pyramidal mount

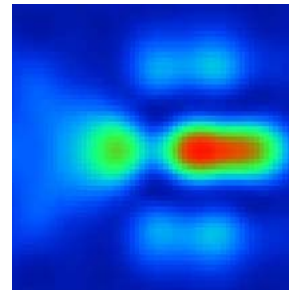

Pyramid Errors
w/o FSM Correction
SR = 0.444

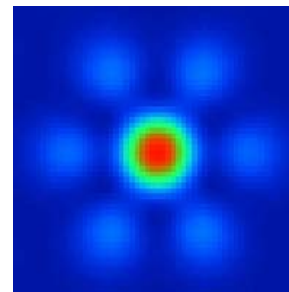

Pyramid Errors
w/ FSM Correction
SR = 0.960



Attitude Control System (ACS)

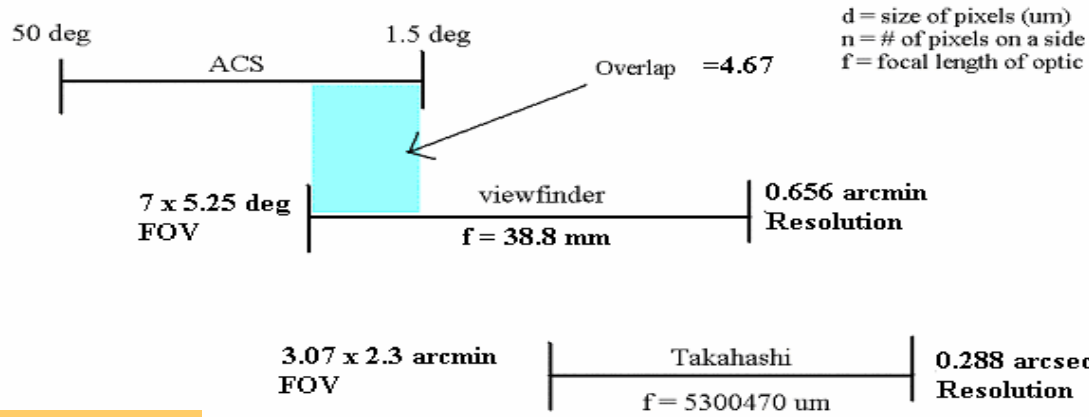

Sensor 1:
Electronic Compass

Active
Balancing
System

Sensor 2:
Viewfinder

ACS
Actuator:
Reaction
Wheel

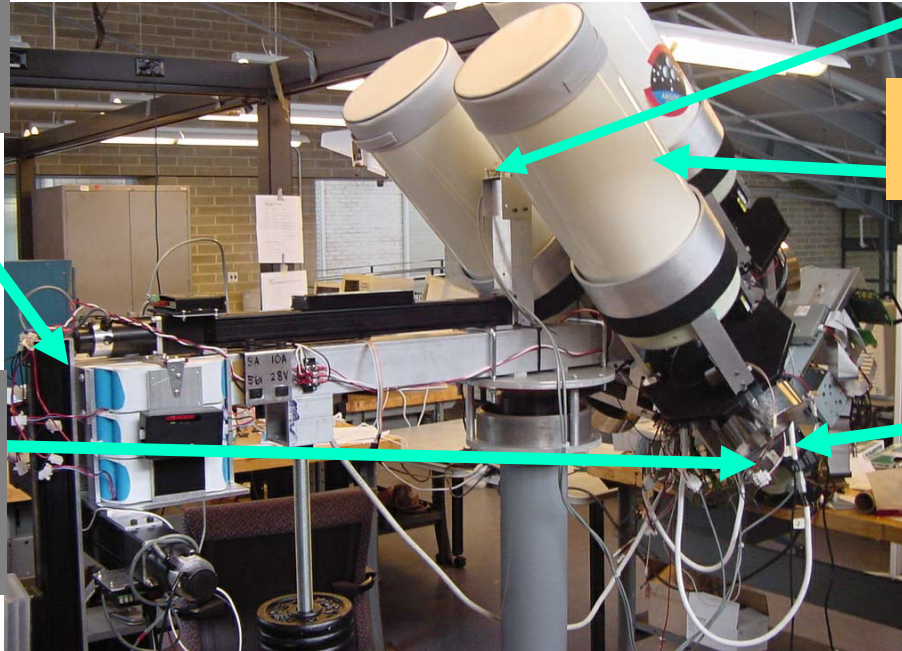

#53-155

Sensor 3:
Rate Gyro





Structures Design

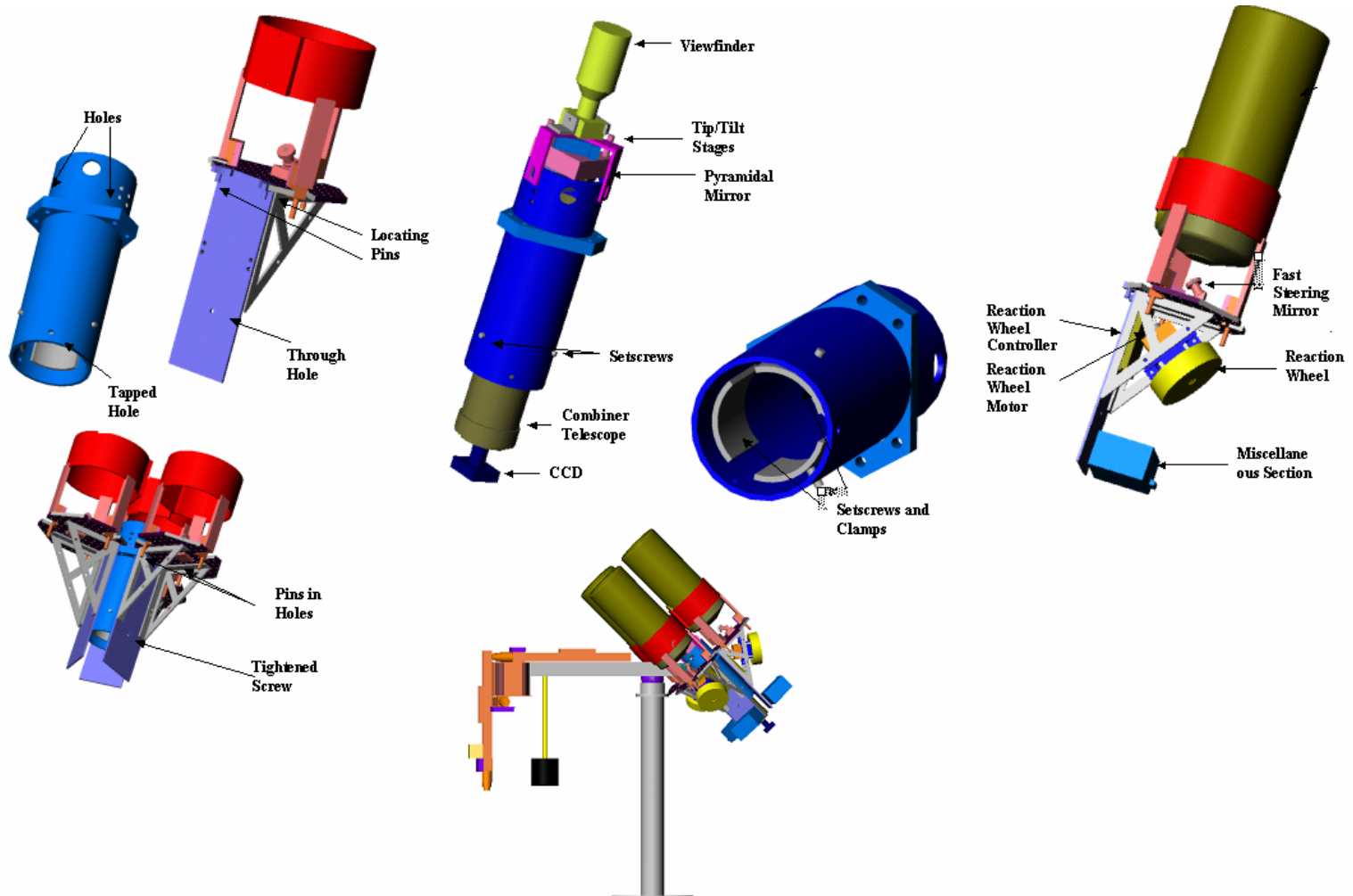



Sparse-aperture Optics/Control System (SOCS) Framework

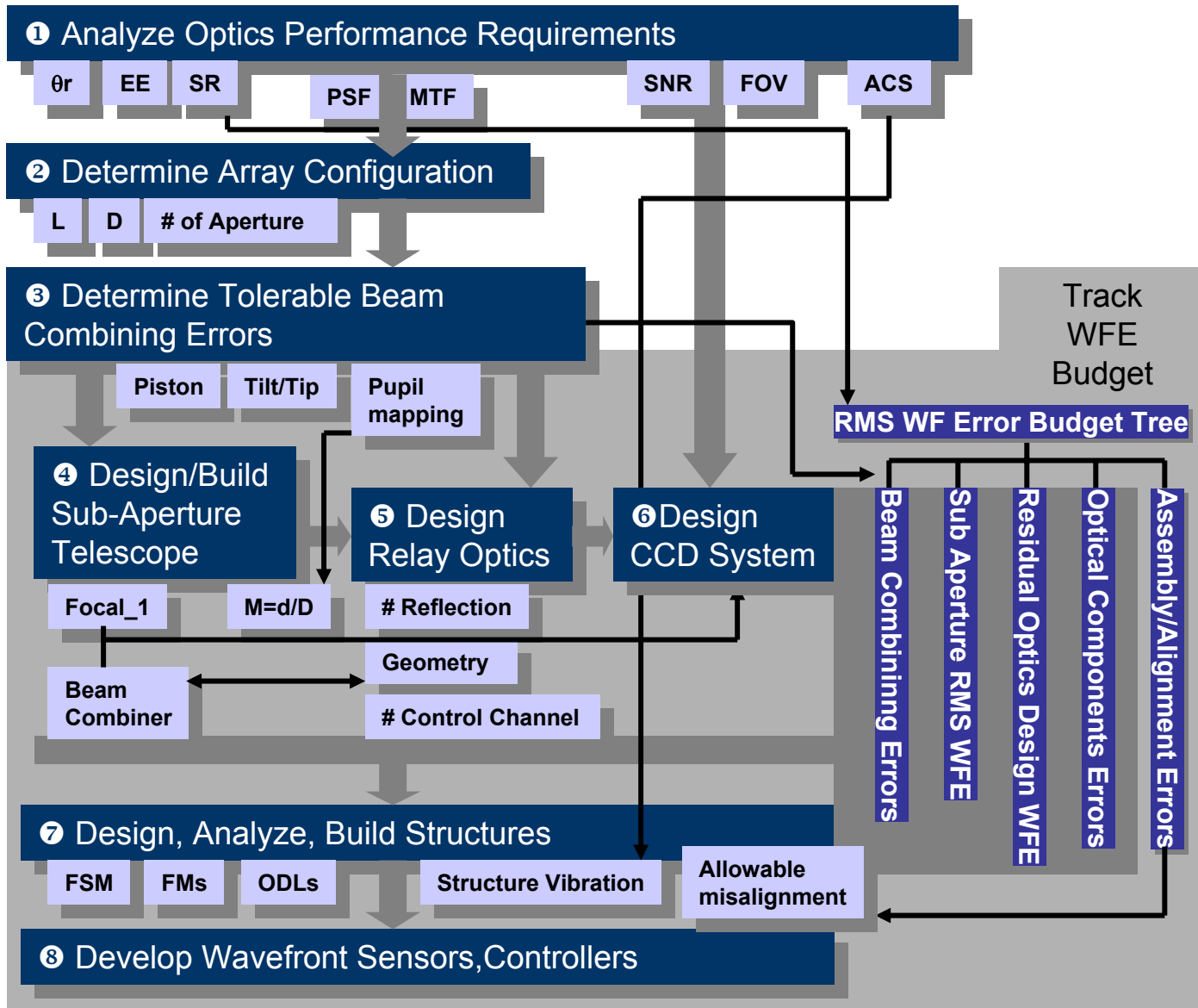



Determination of Array Configuration

$P(\xi, \zeta)$
Complex Pupil Function

Auto-correlation \rightarrow $H(\xi, \zeta)$
Optical Transfer Function (OTF)

$A(x, y)$
Amplitude Spread Function

$\text{abs}(\)^2 \rightarrow$ $S(x, y)$
Point Spread Function (PSF)

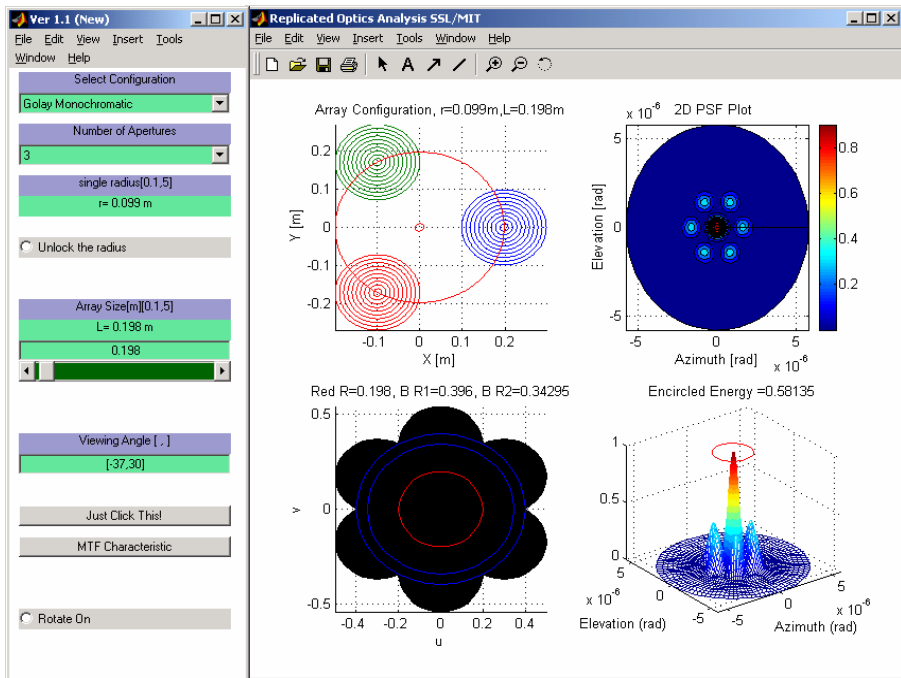
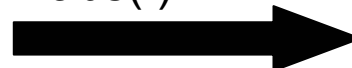
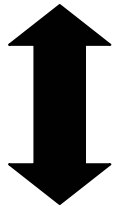

Angular Resolution,
Strehl Ratio Requirement

Find suitable PSF, MTF

Determine the
corresponding L, D

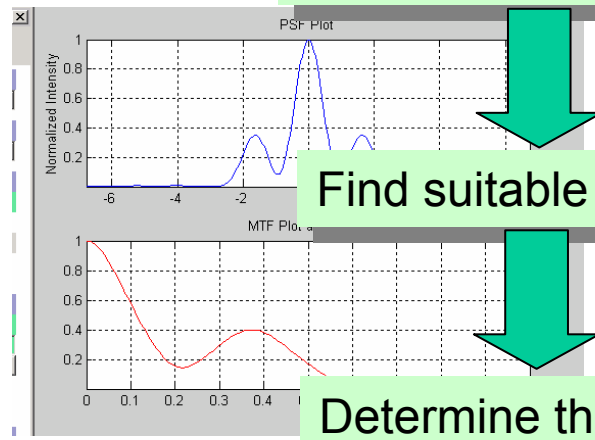



Impact of [L D] on Resolution

Golay Setup w/ Takahashi

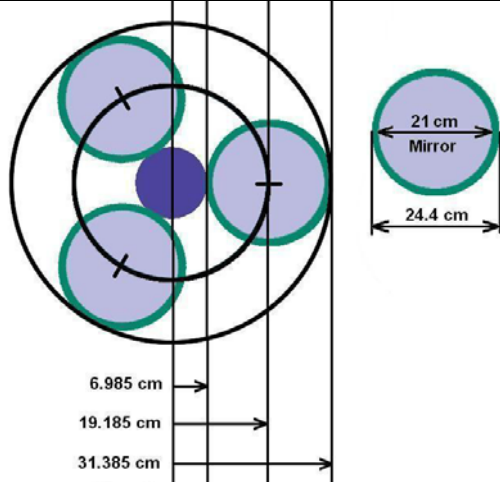

Final Selection for the ARGOS testbed

$L=0.19185\text{ m}$

$D=0.210\text{ m}$ (8 inch COTS telescope)

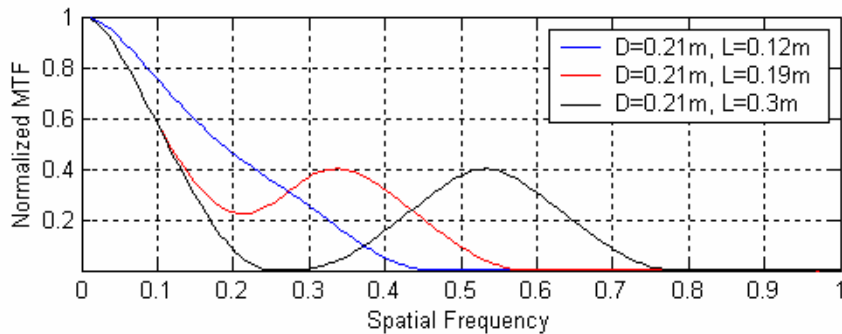
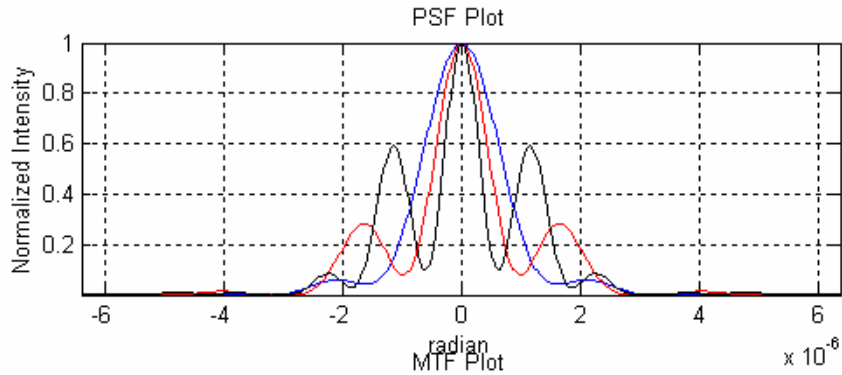

Array Configuration, $r=0.105\text{m}, L=0.12\text{m}$ Array Configuration, $r=0.105\text{m}, L=0.19\text{m}$ Array Configuration, $r=0.105\text{m}, L=0.3\text{m}$

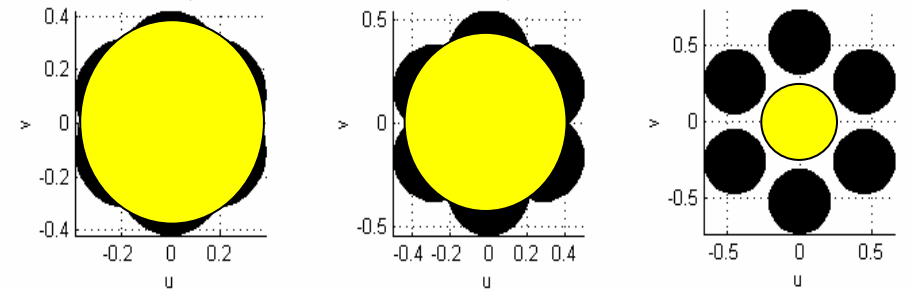
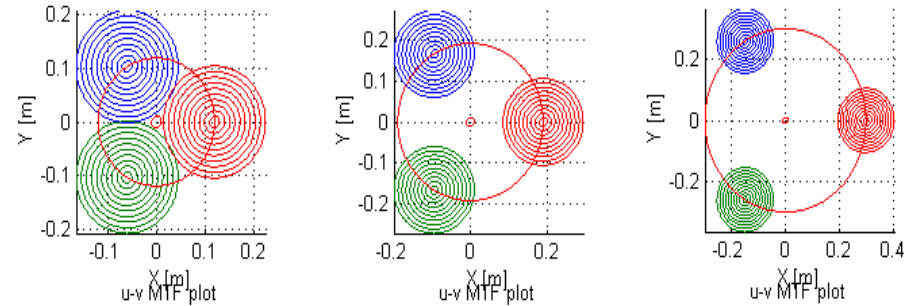



Phasing Error Analysis – Piston(OPD) Error

$$I \propto \left| \frac{\pi D (1 + \cos(r))}{\lambda} \right|^2 \left| \frac{J_1(\pi D \sin r / \lambda)}{\pi D \sin r / \lambda} \right|^2 \left| \sum_{k=1}^n e^{j2\pi(L_k r / \lambda) \cos(\delta_k - \theta)} e^{j\phi_k} \right|^2$$

- Menneson's Equation

$$I_{Array} = 3 + 2\cos(\sqrt{3}\cos(\pi/6 + \theta)2\pi L r / \lambda + \phi_{12})$$

- simplified

$$+ 2\cos(\sqrt{3}\cos(\pi/6 - \theta)2\pi L r / \lambda + \phi_{13}) + 2\cos(\sqrt{3}\sin(\theta)2\pi L r / \lambda + \phi_{23})$$

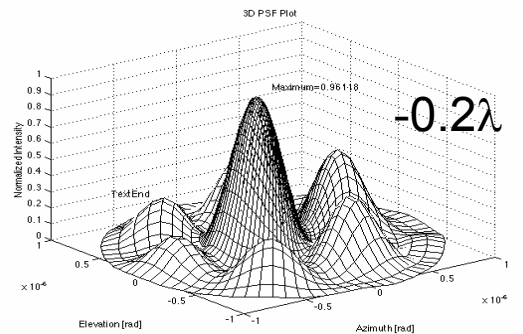
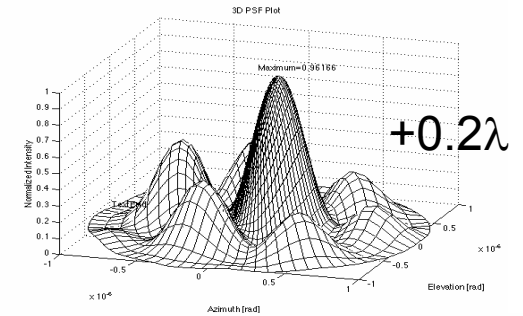
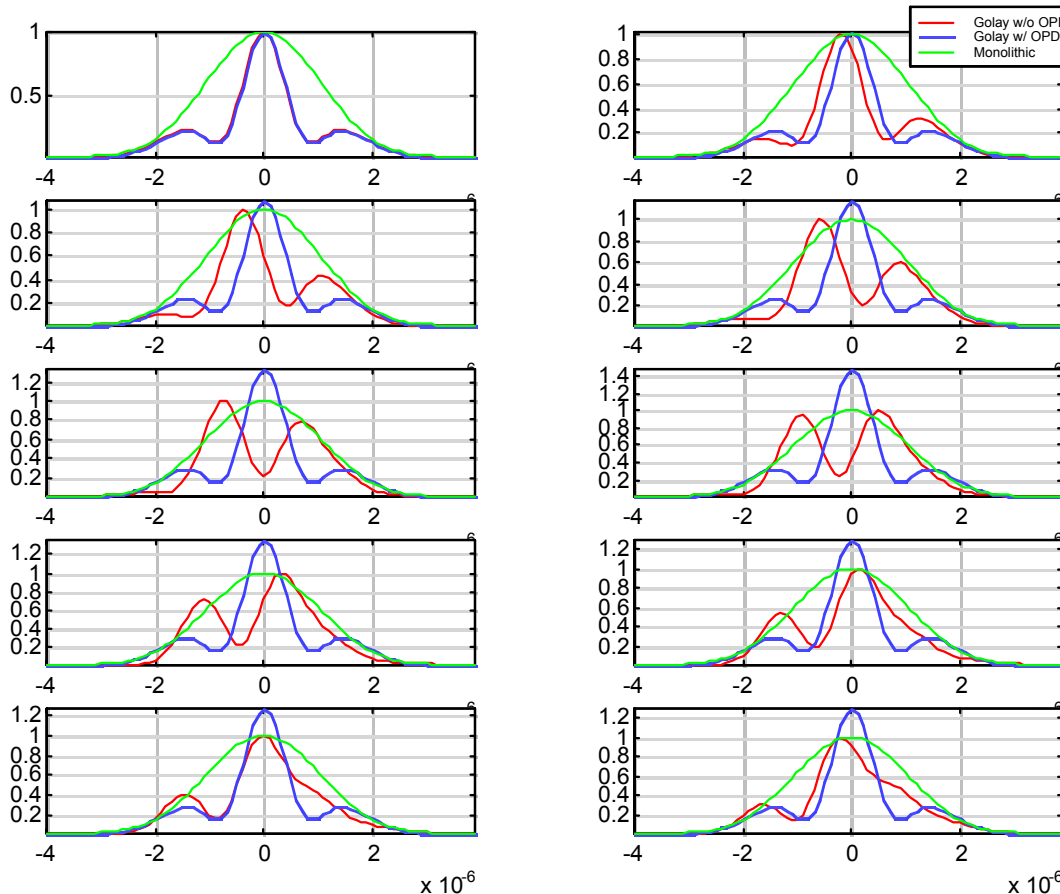

$\lambda/10$ was suggested
as maximum piston
(OPD) error



Phasing Error Requirement – Tilt / Pupil Mapping Error

FEM Tilt Error Analysis
predicts maximum
allowable: $0.35 \mu\text{rad} = 20 \mu \text{Deg}$

Pupil Mapping Error :
Golden Rule of Beam Combining

D/L (Entrance Pupil) = d/l (exit pupil)

Max allowable = $12 \mu\text{m}$

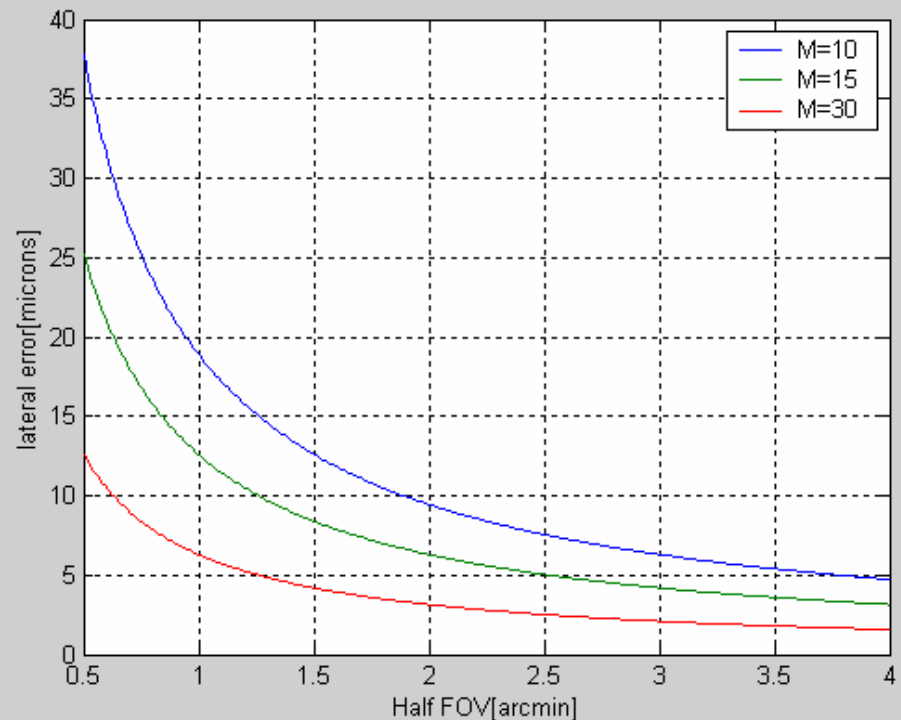
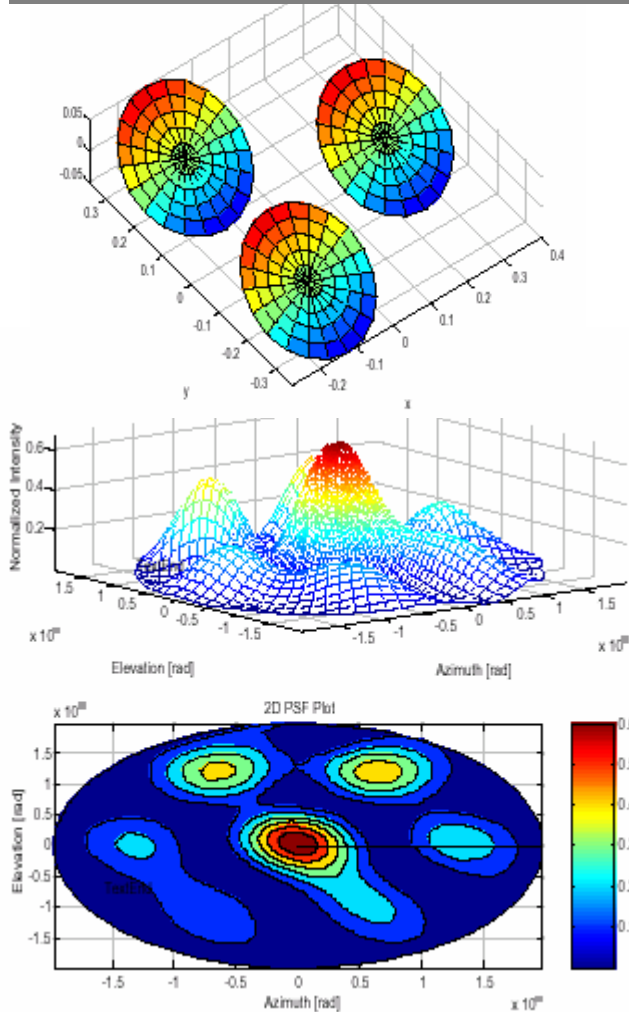



Magnification vs Shear Error

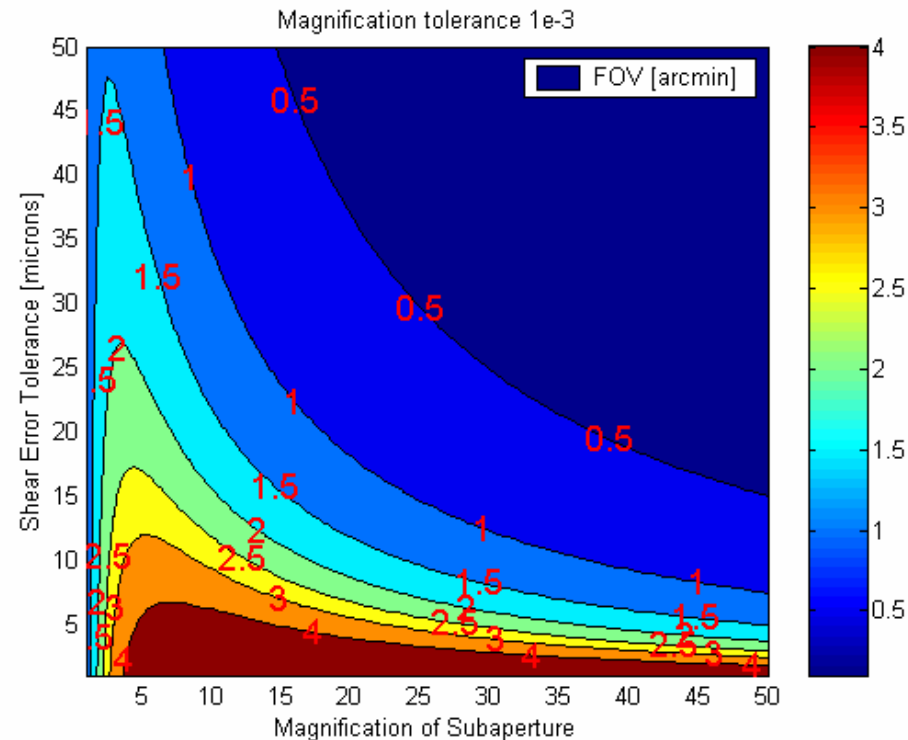
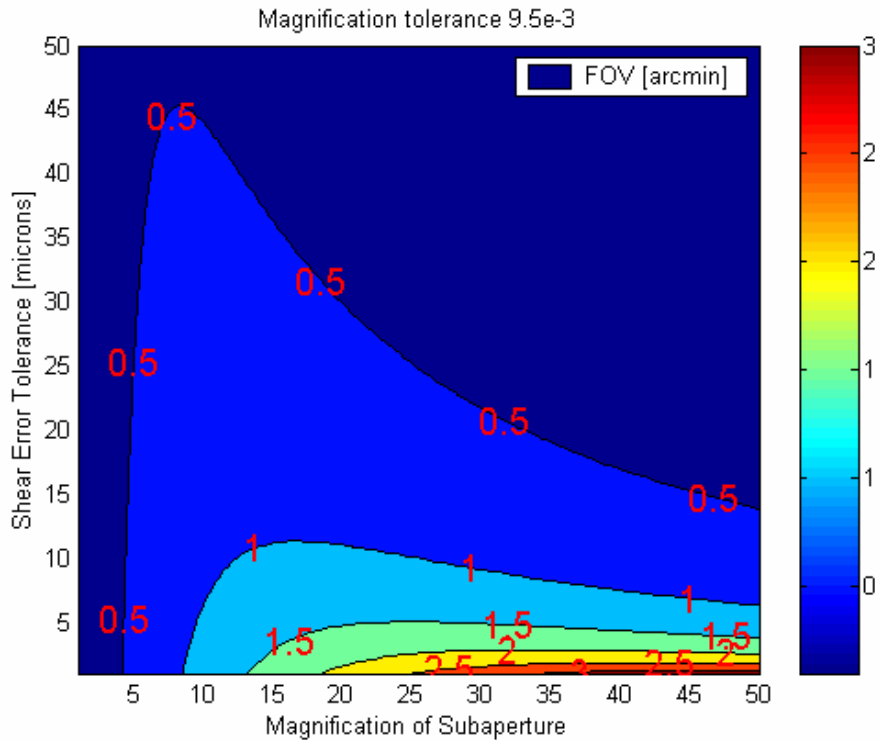

- Sub-aperture magnification can be tuned to maximize allowable shear error (lateral pupil mapping error) thereby reducing control complexity.

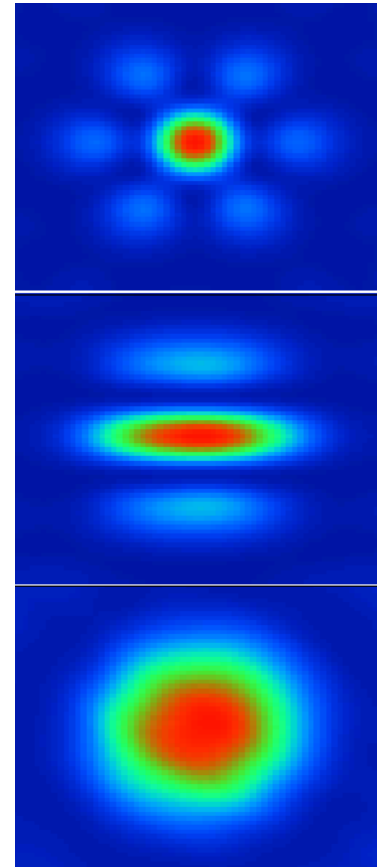
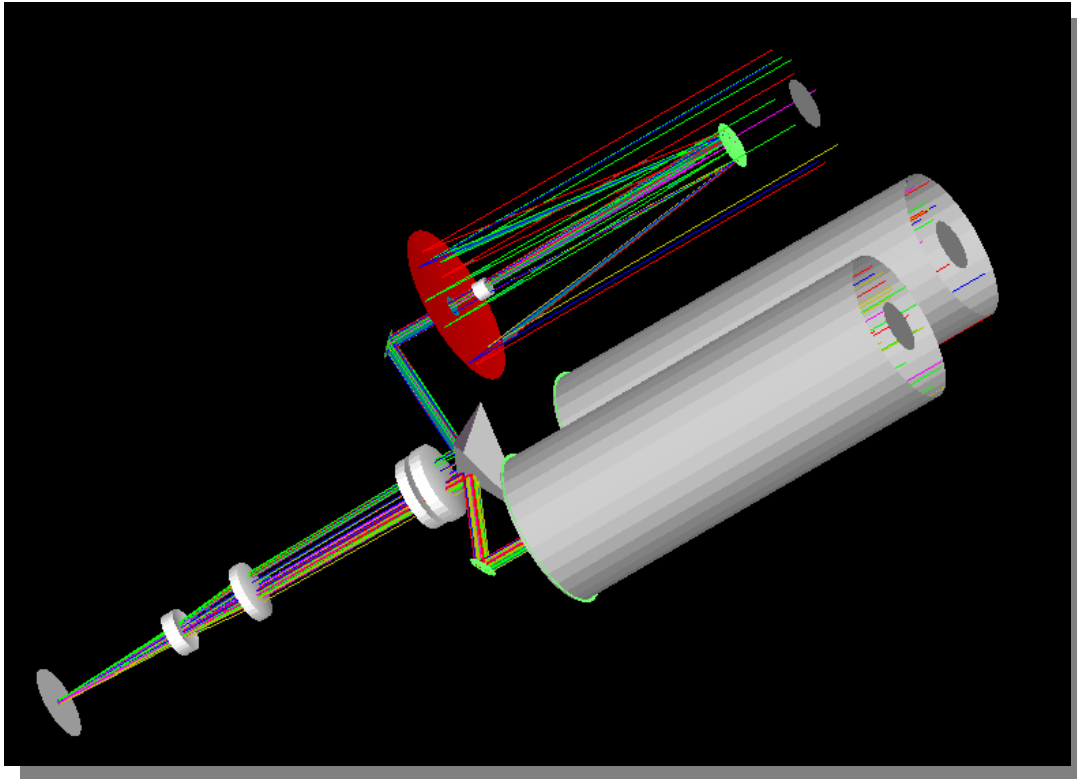

- Zemax is a professional ray tracing/optical design software
- Sequential, Nonsequential Ray Tracing
- Optimization of optics design
- PSF, MTF, Spot Diagram, Imaging Analysis
- Tolerancing and Sensitivity Analysis



Complete WF Error Budget

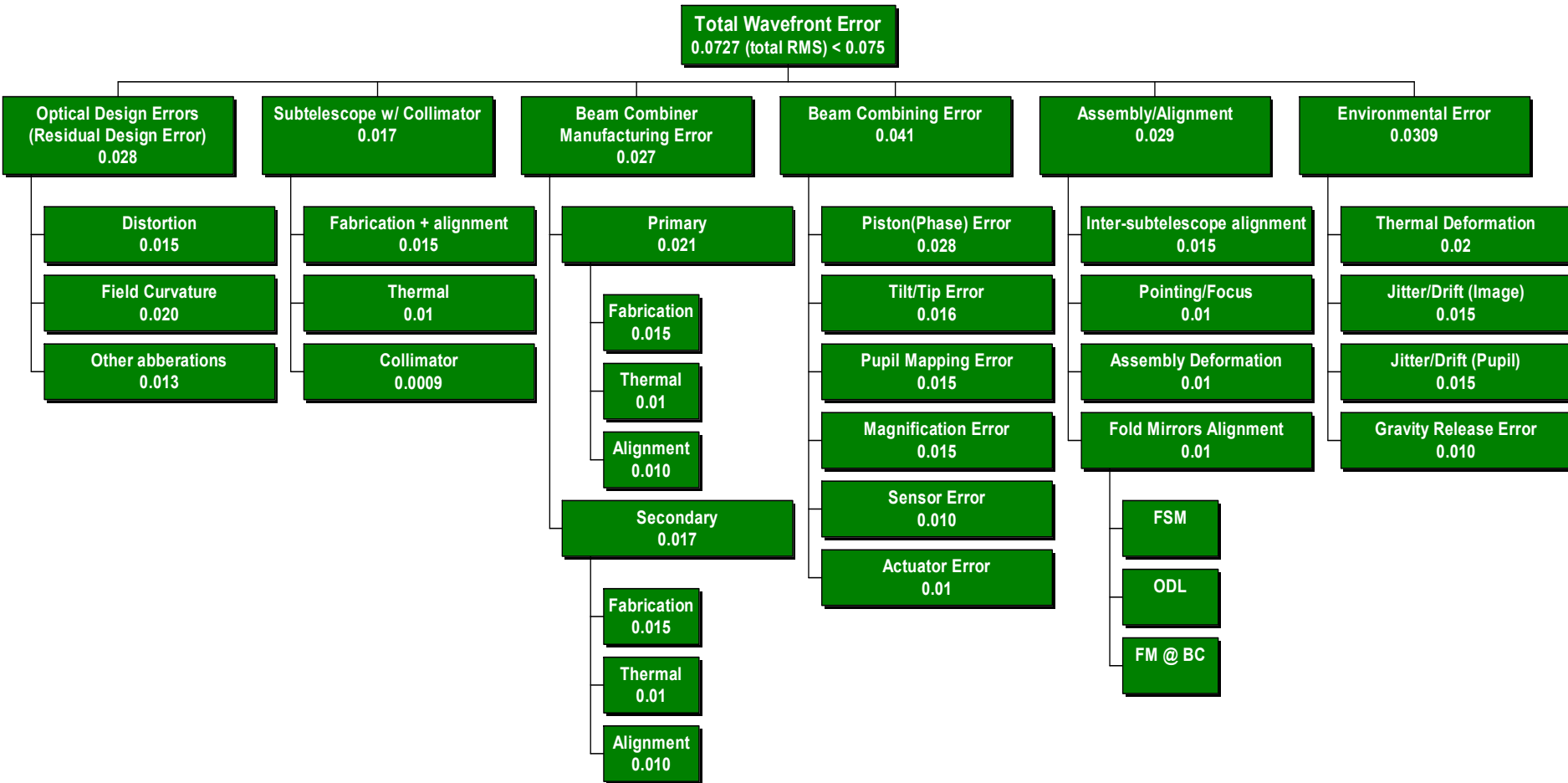

$$\text{Strehl Ratio} = e^{-(2\pi\sigma/\lambda)^2}, \sigma = \text{RMS Wavefront error.}$$

Optical Cost Models

- Investigate economical viability of modular optics given performance constraints
- Focus on monolithic Cassegrain telescopes versus Golay-3 design
- Use real data and experience from ARGOS

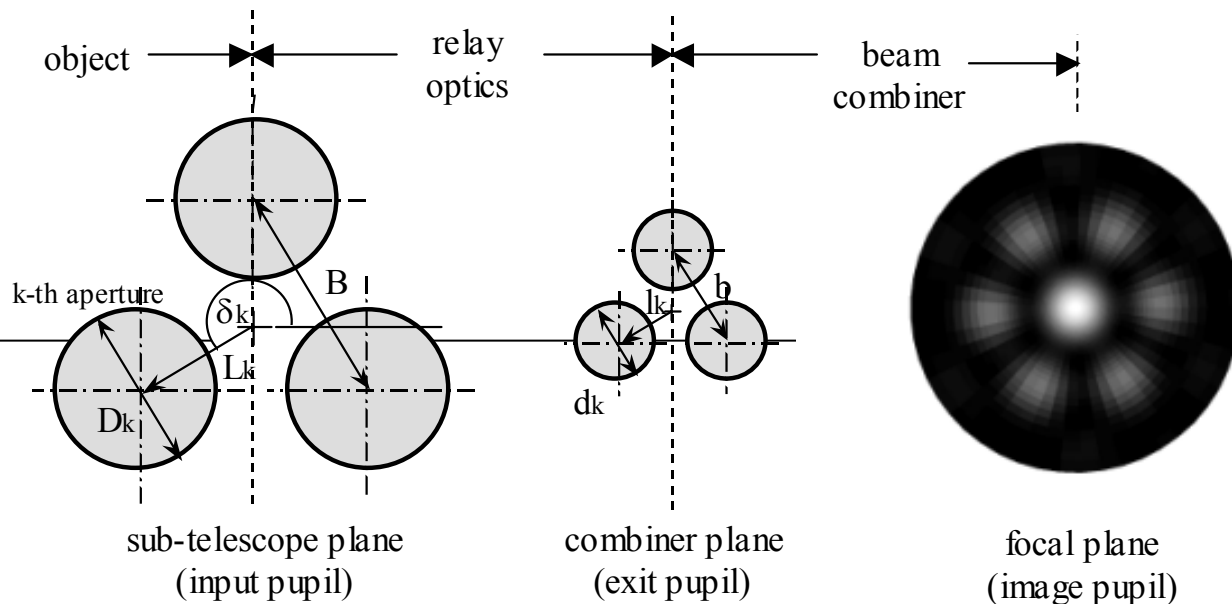



Literature Search for Cost Models

Kahan, Targrove, “Cost modeling of large spaceborne optical systems”, SPIE, Kona, 1998

Humphries, Reddish, Walshaw, “Cost scaling laws and their origin: design strategy for an optical array telescope”, IAU, 1984

Meinel, “Cost-scaling laws applicable to very large optical telescopes”, SPIE, 1979

Meinel’s law: $S = 0.37 \cdot D^{2.58}$ [M\$] (1980)



Small Amateur Telescopes

- Priced various amateur telescopes

- DHQ f/5
- DHQ f/4.5
- D Truss f/5
- Obsession f/4.5
- Celestron G-f/10

- Fit power law

$$C = 28917D^{2.76}$$

- Exponent surprisingly similar to Meinel's Law

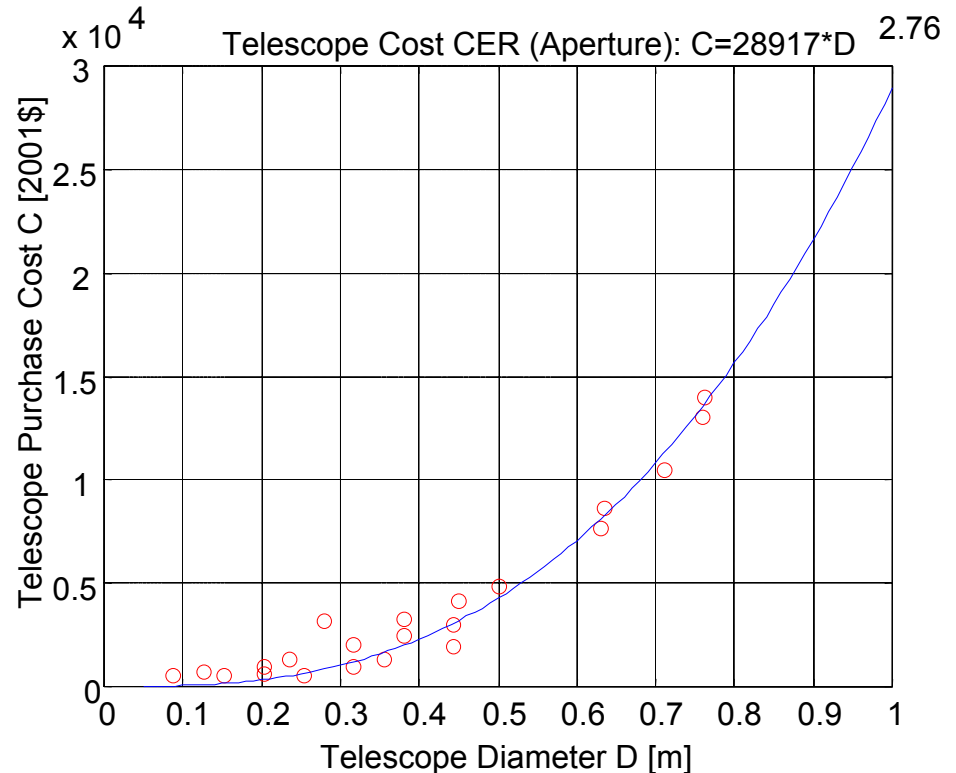



Professional Telescope OTA cost

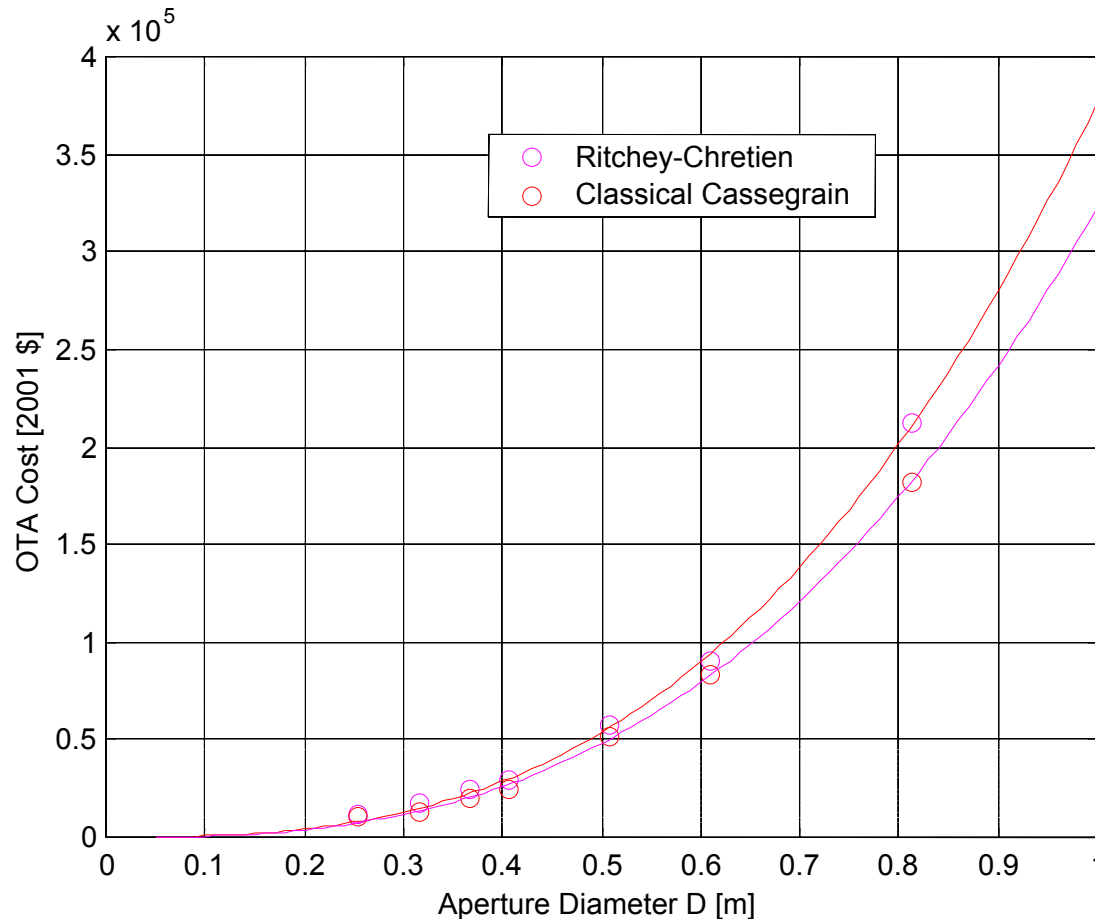

CERs for
Ritchey-Chretien

$$C_{RC} = 376000 \cdot D^{2.80}$$

Classical Cassegrain

$$C_{CC} = 322840 \cdot D^{2.75}$$

Remarkable Result:
virtually identical
power law across
completely different
product lines.

Company: Optical Guidance Systems
(<http://www.opticalguidancesystems.com>)



ACS Mass and Cost

- Reaction wheel mass scales w/ momentum capacity

$$Kg = 2.49 Nms^{0.41}$$

- Reaction wheels dominate ACS mass
- ACS cost is function of mass

$$\$_{ACS} = c_o Kg_{ACS}^{0.8}$$

- Scale using ARGOS ACS mass and cost
- Inertia depends on sub-aperture masses and geometry
- Assumed 1.5 deg/sec slew rate

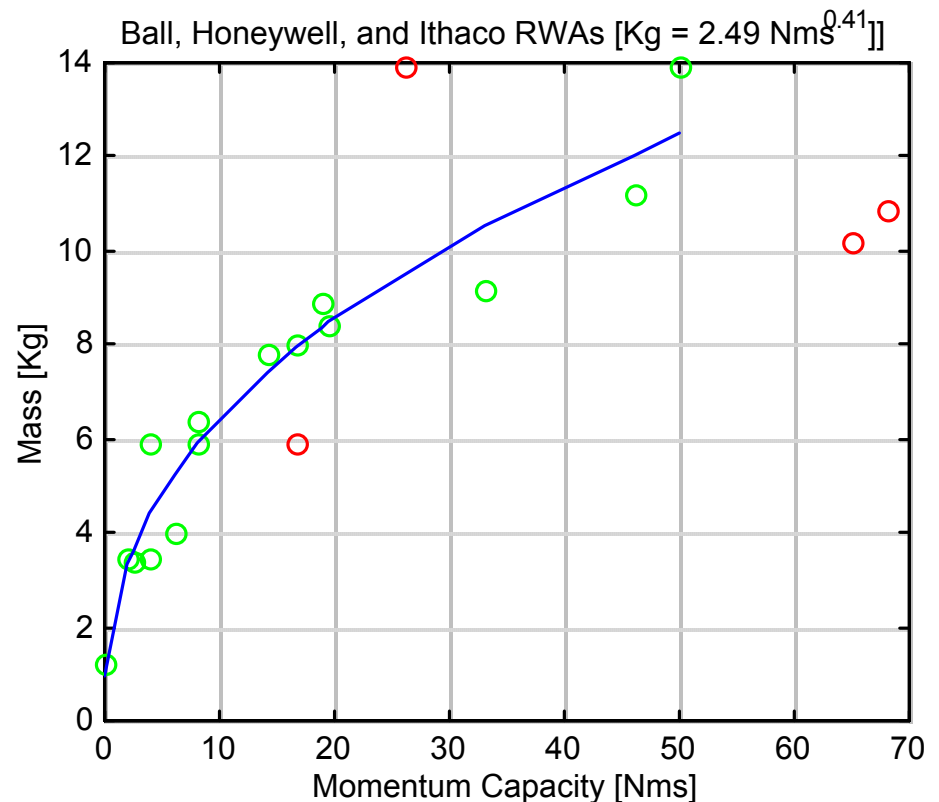



Sub-System Cost Tables

Passive Optics

Item	Unit Cost (US\$)	Quantity Bought	Actual Cost (US\$)	Monolith Quantity	Monolith Cost	Golay-3 Quantity	Golay-3 Cost	Golay-6 Quantity	Golay-6 Cost	Golay-9 Quantity	Golay-9 Cost	Golay-12 Quantity	Golay-12 Cost
Takahashi Telescope (Used)	\$2,339	1	\$2,339	0	\$0	0	\$0	0	\$0	0	\$0	0	\$0
Takahashi Telescope	\$2,800	2	\$5,600	0	\$0	3	\$8,400	0	\$0	0	\$0	0	\$0
Sub-Aperture (D=0.4169m)	\$18,140	0	\$0	1	\$18,140	0	\$0	0	\$0	0	\$0	0	\$0
Sub-Aperture (D=0.09393m)	\$377	0	\$0	0	\$0	0	\$0	6	\$2,259	0	\$0	0	\$0
Sub-Aperture (D=0.0618m)	\$127	0	\$0	0	\$0	0	\$0	0	\$0	9	\$1,141	0	\$0
Sub-Aperture (D=0.0463m)	\$60	0	\$0	0	\$0	0	\$0	0	\$0	0	\$0	12	\$718
Beam Combiner	\$3,624	1	\$3,624	1	\$3,624	1	\$3,624	1	\$3,624	1	\$3,624	1	\$3,624
Collimator	\$2,300	4	\$9,200	0	\$0	3	\$6,900	6	\$13,800	9	\$20,700	12	\$27,600
Collimator Engineering	\$2,500	1	\$2,500	0	\$0	0	\$0	0	\$0	0	\$0	0	\$0
Collimator Mounting	\$500	3	\$1,500	0	\$0	3	\$1,500	6	\$3,000	9	\$4,500	12	\$6,000
Pyramidal Mirror	\$3,000	1	\$3,000	0	\$0	1	\$3,000	1	\$3,000	1	\$3,000	1	\$3,000
Optical Instruments (Fold Mirrors etc.)	\$1,948	1	\$1,948	0	\$0	1	\$1,948	2	\$3,896	3	\$5,844	4	\$7,792
Charged Coupled Device (CCD) Dragonfly	\$1,495	3	\$4,485	2	\$2,990	2	\$2,990	2	\$2,990	2	\$2,990	2	\$2,990
Firewire Card	\$90	2	\$180	2	\$180	2	\$180	2	\$180	2	\$180	2	\$180
Flock Paper/Adhesive	\$106	1	\$106	1	\$106	1	\$106	1	\$106	1	\$106	1	\$106
Compression Ring/Adapter Sleeve	\$132	1	\$132	1	\$132	1	\$132	1	\$132	1	\$132	1	\$132
Optical Posts/Shear Plate	\$1,617	1	\$1,617	0	\$0	0	\$0	0	\$0	0	\$0	0	\$0
Telephoto Lens	\$500	1	\$500	1	\$500	1	\$500	1	\$500	1	\$500	1	\$500
Total			\$36,730		\$25,171		\$28,779		\$32,986		\$42,216		\$52,141

Active Optics

Item	Unit Cost (US\$)	Quantity Bought	Actual Cost (US\$)	Monolith Quantity	Monolith Cost	Golay-3 Quantity	Golay-3 Cost	Golay-6 Quantity	Golay-6 Cost	Golay-9 Quantity	Golay-9 Cost	Golay-12 Quantity	Golay-12 Cost
Fast Steering Mirror (FSM)	\$2,575	3	7,725	1	\$2,575	3	\$7,725	6	\$15,450	9	\$23,175	12	\$30,900
Precision Mount For Combiner	\$3,000	1	3,000	0	\$0	1	\$3,000	1	\$3,000	1	\$3,000	1	\$3,000
1 Channel PZT Amplifier	\$515	9	4,635	3	\$1,545	9	\$4,635	18	\$9,270	27	\$13,905	36	\$18,540
Mirror Mounts w/ High Precision screws	\$177	4	708	1	\$177	3	\$531	6	\$1,062	9	\$1,593	12	\$2,124
Pyramidal Mirror Mount Combo	\$1,048	1	1,048	0	\$0	1	\$1,048	1	\$1,048	1	\$1,048	1	\$1,048
Test PC	\$842	1	842	0	\$0	0	\$0	0	\$0	0	\$0	0	\$0
Optics Electronics	\$584	1	584	1	\$584	1	\$584	1	\$584	1	\$584	1	\$584
Amplifier Boards	\$45	6	270	1	\$45	3	\$135	6	\$270	9	\$405	12	\$540
Cleaning Materials	\$55	1	55	0	\$0	0	\$0	0	\$0	0	\$0	0	\$0
Electronic Focuser and Adapter	\$684	1	684	1	\$684	1	\$684	1	\$684	1	\$684	1	\$684
Optics Hardware	\$13	1	13	1	\$13	1	\$13	1	\$13	1	\$13	1	\$13
Large Knobs	\$4	10	40	3	\$12	9	\$36	18	\$72	27	\$108	36	\$144
DAC Channels	\$259	12	3,113	3	\$778	9	\$2,334	18	\$4,669	27	\$7,003	36	\$9,338
Total			22,716		\$6,413		\$20,725		\$36,122		\$51,518		\$66,914



Sub-System Cost Tables

Attitude Control System

Item	Unit Cost (US\$)	Quantity Bought	Actual Cost (US\$)	Monolith Quantity	Monolith Cost	Golay-3 Quantity	Golay-3 Cost	Golay-6 Quantity	Golay-6 Cost	Golay-9 Quantity	Golay-9 Cost	Golay-12 Quantity	Golay-12 Cost
Fly Wheels	\$300	3	\$900	3	\$900	3	\$900	3	\$900	3	\$900	3	\$900
Rate Gyros	\$3,000	0	\$0	1	\$3,000	1	\$3,000	1	\$3,000	1	\$3,000	1	\$3,000
Motor, Tachometers, Amplifiers	\$802	3	\$2,406	3	\$2,406	3	\$2,406	3	\$2,406	3	\$2,406	3	\$2,406
TCM-2-50 (Tilt Inclinometer/Magnetometer)	\$769	1	\$769	1	\$769	1	\$769	1	\$769	1	\$769	1	\$769
TCM-2-20 (Tilt Inclinometer/Magnetometer)	\$699	1	\$699	0	\$0	0	\$0	0	\$0	0	\$0	0	\$0
Active Balancer	\$2,163	3	\$6,490	3	\$6,490	3	\$6,490	3	\$6,490	3	\$6,490	3	\$6,490
Lab/Power Supplies	\$442	1	\$442	0	\$0	0	\$0	0	\$0	0	\$0	0	\$0
DAC Channels	\$259	3	\$778	3	\$778	3	\$778	3	\$778	3	\$778	3	\$778
ADC Channels	\$281	6	\$1,688	6	\$1,688	6	\$1,688	6	\$1,688	6	\$1,688	6	\$1,688
Filters for Rate Gyros	\$283	1	\$283	1	\$283	1	\$283	1	\$283	1	\$283	1	\$283
Balancing Fly Wheels	\$250	0	\$0	3	\$750	3	\$750	3	\$750	3	\$750	3	\$750
Total			\$14,455		\$17,064		\$17,064		\$17,064		\$17,064		\$17,064

Structures

Item	Unit Cost (US\$)	Quantity Bought	Actual Cost (US\$)	Monolith Quantity	Monolith Cost	Golay-3 Quantity	Golay-3 Cost	Golay-6 Quantity	Golay-6 Cost	Golay-9 Quantity	Golay-9 Cost	Golay-12 Quantity	Golay-12 Cost
Collar	\$583	3	\$1,750	2	\$1,167	3	\$1,750	5	\$2,917	7	\$4,083	9	\$5,250
Translation Stages	\$234	9	\$2,106	0	\$0	9	\$2,106	18	\$4,212	27	\$6,318	36	\$8,424
Bread Boards	\$176	4	\$706	1	\$176	3	\$529	6	\$1,058	9	\$1,588	12	\$2,117
Adapter Plates	\$38	10	\$380	0	\$0	9	\$342	18	\$684	27	\$1,026	36	\$1,368
Nuts, Bolts, Tools, Cables, Connections etc.	\$378	1	\$378	0.5	\$189	1	\$378	2	\$755	3	\$1,133	4	\$1,510
Model SRA250 Spherical Air Bearing	\$12,900	1	\$12,900	0	\$0	0	\$0	0	\$0	0	\$0	0	\$0
Pedestal for Spherical Air Bearing	\$980	1	\$980	0	\$0	0	\$0	0	\$0	0	\$0	0	\$0
Air Supply Filter	\$1,870	1	\$1,870	0	\$0	0	\$0	0	\$0	0	\$0	0	\$0
Vibration Suppression Mounts	\$2	15	\$36	12	\$29	12	\$29	12	\$29	12	\$29	12	\$29
Angle Braces	\$199	6	\$1,194	0	\$0	6	\$1,194	12	\$2,388	18	\$3,582	24	\$4,776
Machine Shop	\$7,059	1	\$7,059	1	\$7,059	1	\$7,059	1	\$7,059	1	\$7,059	1	\$7,059
Center Structure Assembly	\$700	1	\$700	1	\$700	1	\$700	1	\$700	1	\$700	1	\$700
Total			\$30,058		\$9,320		\$14,087		\$19,802		\$25,518		\$31,233

Science, Operations, & Communications

Item	Unit Cost (US\$)	Quantity Bought	Actual Cost (US\$)	Monolith Quantity	Monolith Cost	Golay-3 Quantity	Golay-3 Cost	Golay-6 Quantity	Golay-6 Cost	Golay-9 Quantity	Golay-9 Cost	Golay-12 Quantity	Golay-12 Cost
WLS LAN PCI Cards 11 Mbps	\$230	1	\$230	1	\$230	1	\$230	1	\$230	1	\$230	1	\$230
Wireless Broadband Gateway	\$250	1	\$250	0	\$0	0	\$0	0	\$0	0	\$0	0	\$0
Wireless LAN card	\$131	1	\$131	0	\$0	0	\$0	0	\$0	0	\$0	0	\$0
Portable Computer	\$1,697	1	\$1,697	0	\$0	0	\$0	0	\$0	0	\$0	0	\$0
Total			\$2,307		\$230		\$230		\$230		\$230		\$230



Sub-System Cost Tables

Power, Avionics, & Software

Item	Unit Cost (US\$)	Quantity Bought	Actual Cost (US\$)	Monolith Quantity	Monolith Cost	Golay-3 Quantity	Golay-3 Cost	Golay-6 Quantity	Golay-6 Cost	Golay-9 Quantity	Golay-9 Cost	Golay-12 Quantity	Golay-12 Cost
PC Power Supply	\$165	2	\$331	1	\$165	1	\$165	1	\$165	1	\$165	1	\$165
Batteries	\$165	10	\$1,651	6	\$991	6	\$991	6	\$991	6	\$991	6	\$991
Chargers	\$130	6	\$782	0	\$0	0	\$0	0	\$0	0	\$0	0	\$0
Power Electronics	\$413	1	\$413	1	\$413	1	\$413	1	\$413	1	\$413	1	\$413
Gas Gauge Chip Circuit Boards	\$44	10	\$439	6	\$263	6	\$263	6	\$263	6	\$263	6	\$263
Misc PC Parts for test computer	\$528	1	\$528	0	\$0	0	\$0	0	\$0	0	\$0	0	\$0
Shuttle AK31 Motherboard	\$102	1	\$102	1	\$102	1	\$102	1	\$102	1	\$102	1	\$102
AMD 1.4 GHz Athlon CPU	\$139	1	\$139	1	\$139	1	\$139	1	\$139	1	\$139	1	\$139
Mushkin 512 MB DDR RAM	\$274	3	\$821	2	\$547	2	\$547	2	\$547	2	\$547	2	\$547
Simpletech 512 MB Compact Flash Card	\$353	1	\$353	0	\$0	0	\$0	0	\$0	0	\$0	0	\$0
I Code Composer Studio: TMD S324685C-07	\$999	0.5	\$500	0	\$0	0	\$0	0	\$0	0	\$0	0	\$0
TI 6701 EVM: TMD X32006701	\$1,495	2	\$2,990	0	\$0	0	\$0	0	\$0	0	\$0	0	\$0
SMT 320 4 SLOT PCI MOTHERBOARD	\$1,436	1	\$1,436	1	\$1,436	1	\$1,436	1	\$1,436	1	\$1,436	1	\$1,436
SMT 6012 Drivers for 6701	\$383	1	\$383	0	\$0	0	\$0	0	\$0	0	\$0	0	\$0
HEPC8 Module Carrier	\$3,125	1	\$3,125	1	\$3,125	1	\$3,125	1	\$3,125	1	\$3,125	1	\$3,125
HEGD14 DAC	\$2,075	2	\$4,150	0	\$0	0	\$0	0	\$0	0	\$0	0	\$0
HEGD2 ADC	\$2,250	1	\$2,250	0	\$0	0	\$0	0	\$0	0	\$0	0	\$0
Cables/Connectors	\$200	1	\$200	0.5	\$100	1	\$200	1.5	\$300	3	\$600	4.5	\$900
MagicRAM Internal IDE Compact Flash Adapter	\$90	1	\$90	1	\$90	1	\$90	1	\$90	1	\$90	1	\$90
DSP Board Repair	\$450	1	\$450	0	\$0	0	\$0	0	\$0	0	\$0	0	\$0
HESDP Software Developers Pack	\$1,600	1	\$1,600	0	\$0	0	\$0	0	\$0	0	\$0	0	\$0
Heron4 (6701)	\$2,000	1	\$2,000	1	\$2,000	1	\$2,000	1	\$2,000	1	\$2,000	1	\$2,000
RTX Training	\$3,000	1	\$3,000	0	\$0	0	\$0	0	\$0	0	\$0	0	\$0
Total			\$27,730		\$9,370		\$9,470		\$9,570		\$9,870		\$10,170

Miscellaneous

Item	Unit Cost (US\$)	Quantity Bought	Actual Cost (US\$)	Monolith Quantity	Monolith Cost	Golay-3 Quantity	Golay-3 Cost	Golay-6 Quantity	Golay-6 Cost	Golay-9 Quantity	Golay-9 Cost	Golay-12 Quantity	Golay-12 Cost
Office Tools	\$427	1	\$427	0	\$0	0	\$0	0	\$0	0	\$0	0	\$0
Dspace board	\$1,945	1	\$1,945	0	\$0	0	\$0	0	\$0	0	\$0	0	\$0
Summer '01 Supplies	\$258	1	\$258	0	\$0	0	\$0	0	\$0	0	\$0	0	\$0
Air Compressor	\$305	1	\$305	0	\$0	0	\$0	0	\$0	0	\$0	0	\$0
Total			\$2,934		\$0		\$0		\$0		\$0		\$0

			ARGOS		Monolith		Golay-3		Golay-6		Golay-9		Golay-12
Total			\$136,930		\$67,568		\$90,355		\$115,774		\$146,416		\$177,752



Labor Cost Table

Sub-System		Yearly Rate	Hours					ARGOS	
			Spring	Summer	Fall	Spring	Total	Total	Recurring
Passive Optics	Soon-Jo Chung	\$70,000	200	200	200	200	800	\$61,833	\$15,458
	Janaki Wickrema	\$50,000	260	0	260	130	650	\$35,885	\$7,177
	Erik Iglesias	\$50,000	260	360	260	130	1010	\$55,760	\$7,177
	David Ngo	\$50,000	260	360	260	130	1010	\$55,760	\$7,177
Active Optics	Soon-Jo Chung	\$70,000	150	160	150	150	610	\$47,148	\$11,594
	Abran Alaniz	\$50,000	260	360	260	130	1010	\$55,760	\$7,177
	Praxedis Flores III	\$50,000	260	0	260	130	650	\$35,885	\$7,177
ACS	Carl Blaurock	\$70,000	0	0	78	78	156	\$12,058	\$6,029
	Ayanna Samuels	\$50,000	260	0	260	130	650	\$35,885	\$7,177
	Susan Kim	\$50,000	260	0	260	130	650	\$35,885	\$7,177
	Paul Wooster	\$50,000	260	0	260	130	650	\$35,885	\$7,177
Structures	Marc dos Santos	\$50,000	260	0	260	130	650	\$35,885	\$7,177
	David LoBosco	\$50,000	260	0	260	130	650	\$35,885	\$7,177
PAS	Raymond Sedwick	\$70,000	104	96	104	104	408	\$31,535	\$8,038
	Soon-Jo Chung	\$70,000	0	0	0	104	104	\$8,038	\$8,038
	Carolina Tortora	\$50,000	260	0	260	130	650	\$35,885	\$7,177
	Christopher Rakowski	\$50,000	260	360	260	130	1010	\$55,760	\$7,177
	Dustin Berkovitz	\$50,000	260	360	260	130	1010	\$55,760	\$7,177
SOC	John Keesee	\$90,000	104	96	104	104	408	\$40,545	\$10,335
	Eric Coulter	\$50,000	260	0	260	130	650	\$35,885	\$7,177
	Daniel Kwon/Lisa Girerd	\$50,000	260	0	260	130	650	\$35,885	\$7,177
Management	Paul Bauer	\$70,000	104	96	104	104	408	\$31,535	\$8,038
	David Miller	\$90,000	104	48	104	104	360	\$35,775	\$10,335
	Raymond Sedwick	\$70,000	26	0	26	26	78	\$6,029	\$2,010
	John Keesee	\$90,000	26	0	26	26	78	\$7,751	\$2,584
Total								\$919,903	\$190,115

EB/OHD Wrap
2.12
Student
\$50,000
Staff
\$70,000
Management
\$90,000



Labor Cost Table

Sub-System	ARGOS			Monolith			Golay-3		
	mult	Total	Recurring	mult	Total	Recurring	mult	Total	Recurring
Passive Optics	1	\$209,240	\$36,990	0.3	\$62,772	\$11,096.88	1	\$209,240	\$36,990
Active Optics	1	\$138,794	\$25,948	0.3	\$41,638	\$7,784.38	1	\$138,794	\$25,948
ACS	1	\$119,714	\$27,560	1	\$119,714	\$27,560.00	1	\$119,714	\$27,560
Structures	1	\$71,771	\$14,354	0.6	\$43,063	\$8,612.50	1	\$71,771	\$14,354
PAS	1	\$186,980	\$37,608	1	\$186,980	\$37,607.92	1	\$186,980	\$37,608
SOC	1	\$112,316	\$24,689	1	\$112,316	\$24,689.17	1	\$112,316	\$24,689
Management	1	\$81,090	\$22,967	1	\$81,090	\$22,966.67	1	\$81,090	\$22,967
Total		\$919,903	\$190,115		\$647,572	\$140,318		\$919,903	\$190,115
Sub-System	Golay-6			Golay-9			Golay-12		
	mult	Total	Recurring	mult	Total	Recurring	mult	Total	Recurring
Passive Optics	1.5	\$313,859	\$55,484	2	\$418,479	\$73,979	2.5	\$523,099	\$92,474
Active Optics	2	\$277,588	\$51,896	3	\$416,381	\$77,844	4	\$555,175	\$103,792
ACS	1	\$119,714	\$27,560	1	\$119,714	\$27,560	1	\$119,714	\$27,560
Structures	2	\$143,542	\$28,708	3	\$215,313	\$43,063	4	\$287,083	\$57,417
PAS	1	\$186,980	\$37,608	1	\$186,980	\$37,608	1	\$186,980	\$37,608
SOC	1	\$112,316	\$24,689	1	\$112,316	\$24,689	1	\$112,316	\$24,689
Management	1	\$81,090	\$22,967	1	\$81,090	\$22,967	1	\$81,090	\$22,967
Total		\$1,235,088	\$248,912		\$1,550,272	\$307,709		\$1,865,456	\$366,506



Golay System Costs

- Optimum Golay is D_{eff} -dependent
- Labor moves Golay benefits to larger D_{eff}
- Golay's sacrifice Encircled Energy

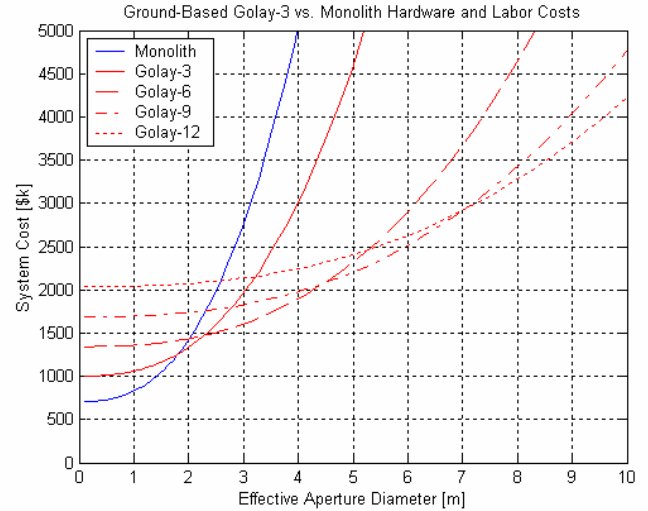
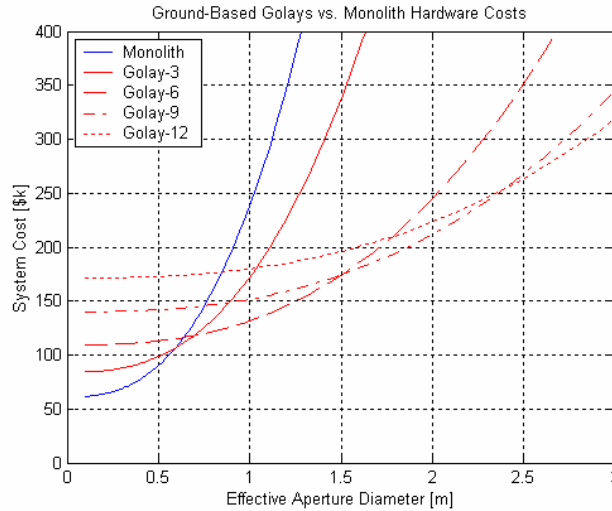

EE=83.5%

EE=26.4%

EE=9.3%

EE=3.6%

EE=2.2%

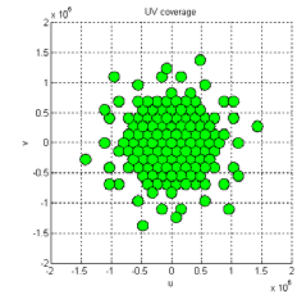
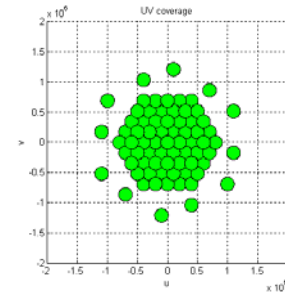
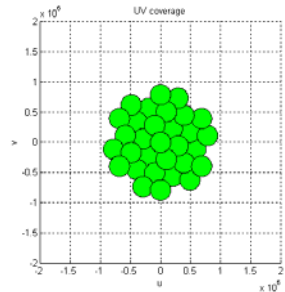
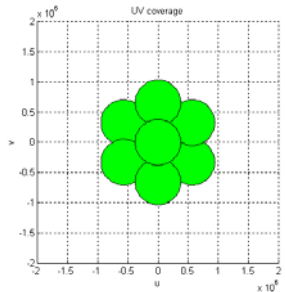
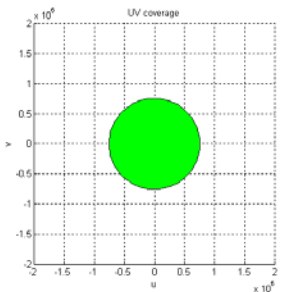
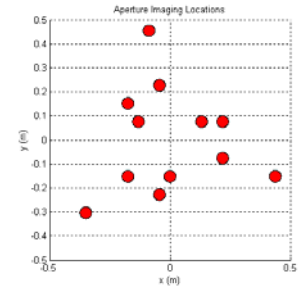
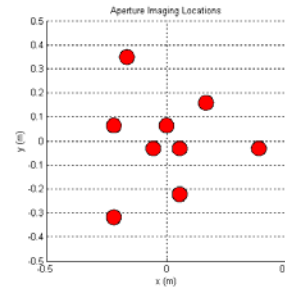
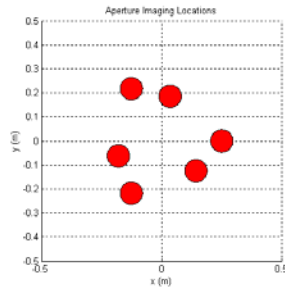
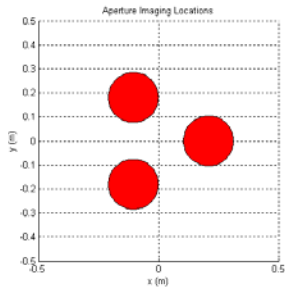
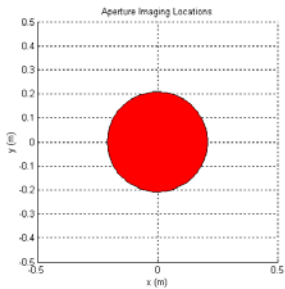



Compact Golay-3

- Reduces side-lobes, improves EE, improves fill factor (SNR)
- Sacrifices cost savings
- Adding bus & relay optics costs defines Golay-3 vs. monolith breakpoint

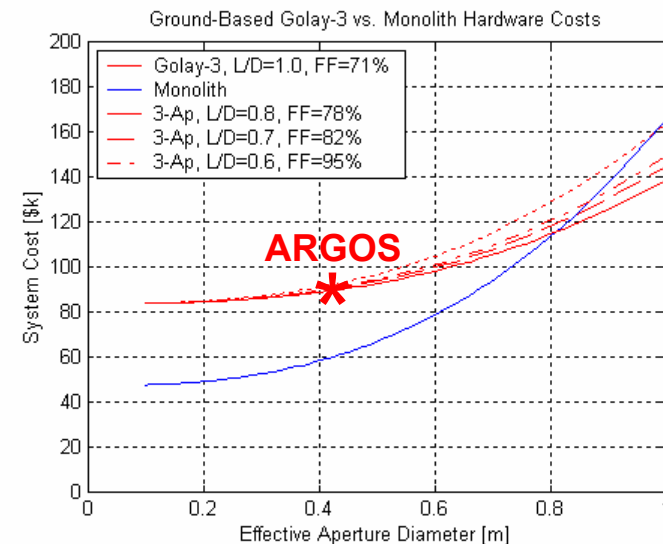
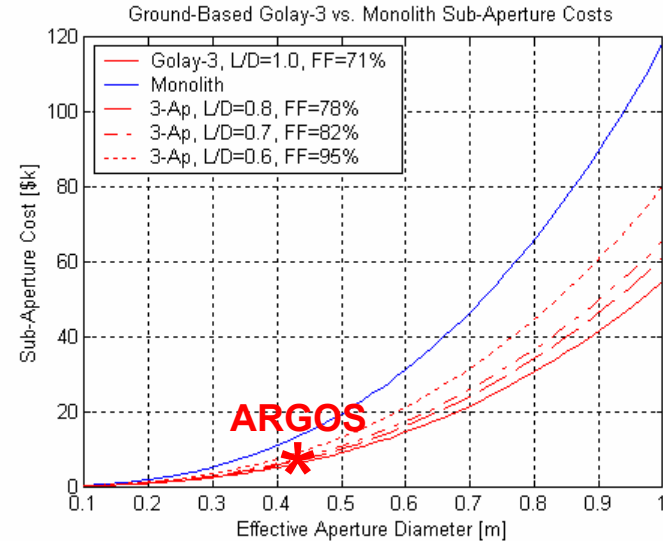
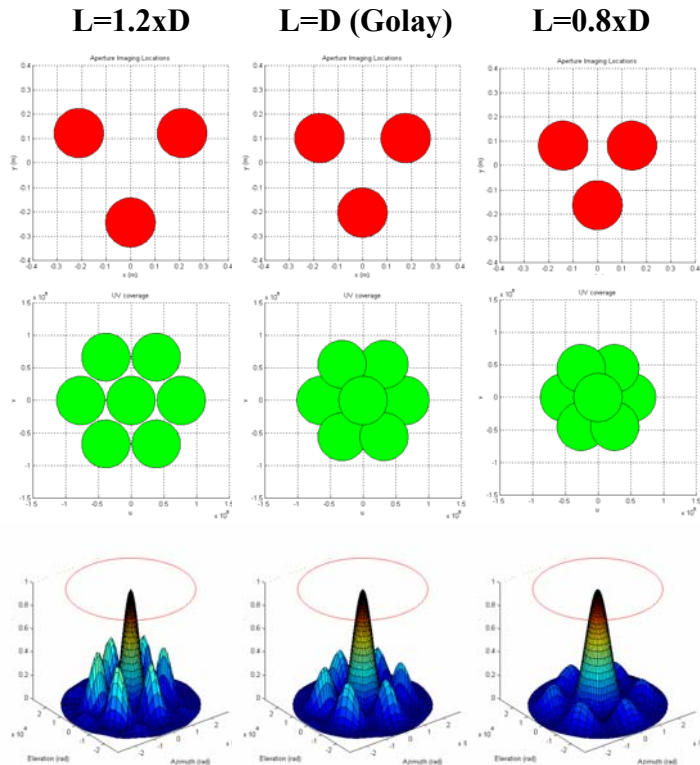



Compact Hex Arrays

- Larger D_{eff} favors higher order Golays
- Golay-3 & Hex compact better than higher order Golays
- Compactness limited by sub-aperture interference
- Hex is not as cost-efficient at providing full uv-coverage as Golay

